

CELEB INSTRUCTIONS FOR USE

Dear Customers

Dear Customers

Thank you for purchasing our product.

This booklet explains how to use CELEB.

Before using CELEB, carefully read the instructions for use and make sure to use the product correctly.

Using the product without reading these instructions may lead to an accident.

For easy access to the information contained herein, keep this booklet at hand and review it as needed.

Ask your local authorized Belmont dealer to install this product by following the installation instructions contained in the product.

If you have any questions regarding the instructions for use or this product, contact your local authorized Belmont dealer.

If you find any dirt on or damage to the booklet and need a new booklet, report the document number indicated below to your local authorized Belmont dealer to order a new one.

This document describes the full version of the system. It may therefore cover components that are not included in the system you purchased.

2024-09 (2nd edition)	
Document number	1E0973C0

	Dear Customers	2
1	General Information	
1-1	Intended Purpose of the Product	6
1-2	Compliance with Directives	6
1-3	Declaration of Conformity	6
1-4	How to Dispose of the Device	7
1-5	Disposal of Residues	7
1-6	Concerning the water used for dental units	7
1-7	Recomendation to User	7
1-8	Compatible Handpieces	8
1-9	Compatible Dental Chairs	8
1-10	Compatible Dental Lights	8
1-11	Compatible Medical devices	8
1-12	Symbols	9
1-13	Technical Description	11
2	Safety Consideration	
2-1	Risk Level Interpretation	12
2-2	Safety Precautions	14
	Points to remember when operating the product	23
2-3	EMC Information	24
2-4	Compatible Handpieces	28
2-5	Compatible Dental Chairs	29
2-6	Compatible Dental Lights	29
2-7	Compatible Medical devices	29
3	Precautions for Use	
3-1	Operating Precautions	30
4	Product Specifications	
4-1	Technical Data	31
	4-1-1 Specification Variations	31
	4-1-2 Chair Mount Over the Patient Type	32
	4-1-3 Chair Mount Cart Type	34
	4-1-4 Pedestal Over the Patient Type	36
	4-1-5 Pedestal Cart Type	38

4 Product Specifications

4-2	Overview and Major Components	40
4-2-1	Over the Patient	40
4-2-2	Cart	41

5 Operation

5-1	Doctor unit section	42
5-1-1	Holder type	42
5-1-2	Rod type	46
5-1-3	Function switch setup procedure	50
5-1-4	Control knobs	54
5-1-5	Handpiece pressure gauge	54
5-1-6	Balance arm air brake	55
5-1-7	Film viewer	55
5-1-8	Holder support arm / Holder	55
5-1-9	Handpieces	56
5-1-10	Table height adjustment (Cart type)	56
5-1-11	Intraoral camera holder bracket	57
5-1-12	Sub tray holder	57
5-1-13	Waste receptacle	57
5-1-14	Cotton Containers	57
5-2	Cuspidor unit section	58
5-2-1	Cuspidor unit control panel	58
5-2-2	Assistant side control panel	59
5-2-3	Control knobs	60
5-2-4	VH-18 HVE (High-volume evacuator)	61
5-2-5	BT06 Saliva ejector	61
5-2-6	Sensor cupfille	61
5-2-7	Cuspidor Bowl Rotation (Optional)	61
5-2-8	Clean water system	62
5-2-9	Height adjustable assistant arm	62
5-2-10	Dental light	63
5-2-11	Monitor Bracket	63
5-3	3WAY Syringe	64
5-4	Foot controller	65
5-5	Lock function	66

6 Maintenance and Cleaning

6-1	Exterior	67
6-2	Doctor unit	67
6-3	Cuspidor unit	69
6-4	Suction line	70
6-5	High-volume evacuator hose/Saliva ejector hose	70
6-6	Water line	70
6-7	High-volume evacuator/Saliva ejector	71
6-8	77 type 3WAY syringe	73
6-9	SYR-20 3WAY syringe	75
6-10	Handpiece hose	77
6-11	Air filter drain valve	77
6-12	Filter replacement	77
6-13	Maintenance and inspection	78
	Notes on daily maintenance and inspection (by the user)	78
	Notes for periodic inspection	80
6-14	Detachable parts	81
6-15	Storage method	81

7 Maintenance by Service Engineers

7-1	After-sales service	82
7-2	Service life	82
7-3	Period of Parts Retention	82

8 Troubleshooting

83

9 Consumables

84

1-1 Intended Purpose of the Product

This product is an active therapeutic device intended for the exclusive use for diagnoses, treatments and relative procedures of dentistry.

The product must be operated or handled by the qualified dentists or by dental staffs under the supervision of the dentist.

Such dentists or dental staffs should instruct and/or assist the patients to approach to and leave from the product.

Patients should not be allowed to operate or handle the product unless he/she is so instructed.

The product is supplied together with the handpieces like electric micromotor, air turbine and/or motor, scaler and so on.

In addition, it is the device which combines with dental chair and dental light.

1-2 Compliance with Directives

This product complies with MDR (EU) 2017/745 and RoHS Directive 2011/65/EU.

1-3 Declaration of Conformity

We hereby declare that the product listed below complies with the general safety and performance requirements of the Medical Device Regulation: 2017/745 and RoHS Directive: 2011/65/EU based on category 8 of Annex I.

Product Type : DENTAL UNIT (CLASS II a)

Product Name : CELEB

" CELEB " has been defined by the rule 9 of MDR Annex VIII. The product has been designed and manufactured in accordance with the European standards as the listed in the Declaration of Conformity.

1-4 How to Dispose of the Device

When disposing of this product and parts replaced, carefully take infection control measures and handle them properly in accordance with the relevant laws and regulations (applicable regulations and local regulations).

In the EU area, EU Directive 2012/19/EU (Directive on Waste Electrical and Electronic Equipment [WEEE Directive]) applies to this product. Environment-conscious recycling/disposal is mandatory under this Directive.

1-5 Disposal of Residues

Ask a professional to dispose of amalgam residues.

1-6 Concerning the water used for dental units

In terms of water used for treatment, use drinking water with water quality conforming to the relevant local regulations or WHO guidelines.

Although the water supply connection parts of this product is equipped with a backflow prevention mechanism, the use of handpieces with an anti-retraction device is strongly recommended when connecting to this product.

1-7 Recommendation to User

A notice to the user and/or patient that any serious incident that has occurred in relation to the device should be reported to the manufacturer and the competent authority of the Member State in which the user and/or patient is established.

1-8 Compatible Handpieces

Select a handpiece from the list of compatible handpieces.
(For reference, see page 28.)

The connectors of our handpiece hose are designed and manufactured in accordance with ISO9168:2009 (DENTIST-RY-HOSE CONNECTORS FOR AIR DRIVEN DENTAL HAND-PIECES). However, there still could be a case that the connectors of turbines or air motors may not fit into some handpieces due to the manufacturing tolerances.

Have your local authorized Belmont dealer to check the connectability before purchasing the handpiece.

Except for our recommended handpieces, we shall not be liable for any problems deriving from bad connectability or their performance.

1-9 Compatible Dental Chairs

Please use the compatible dental chairs described in page 29.

1-10 Compatible Dental Lights





























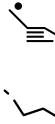



Please use the compatible dental lights described in page 29.

1-11 Compatible Medical devices



























Please use the compatible medical devices described in page 29.

1-12 Symbols

















The symbols listed below are used on this product, on labeling, and in this booklet. Check the meaning of each symbol.

	Switch (ON)		Switch (OFF)
	Switch for raising the chair		Switch for lowering the chair
	Switch for reclining the backrest		Switch for raising the backrest
	Switch for returning to the last position		Automatic return switch
	Preset switch 1		Preset switch 2
 	Switch for raising the chair	 	Switch for lowering the chair
 	Switch for reclining the backrest	 	Switch for raising the backrest
	Switch for manual operation		Switch for Automatic operation
 	Cup filler switch	 	Bowl flush switch
 	Dental light ON/OFF switch	 MANUAL SENSOR 	Dental light mode selection
 sec.	Plus	 min.	Minus
	Handpiece setting		Store switch

1 General Information

 	<p>Electric motor speed set switch</p> <p>Start switch</p>	 	<p>Micromotor rotation switch for normal/reverse</p>
 	<p>Coolant water ON/OFF switch</p>	 	<p>Handpiece light switch (on/off)</p>
	<p>Function switch</p>		<p>Scaler power control</p>
<p>MAIN ○</p>	<p>Power indicator</p>	<p>LOCK ○</p>	<p>Chair lock indicator</p>
<p>E S P</p>	<p>Scaler mode selection E (ENDO) S (SCALING) P (PERIO)</p>	 	<p>3 way syringe</p>
<p>w  A</p>	<p>Water/air flow control of syringe spray</p>		<p>Water heater</p>
	<p>Service coupler for air use</p>		<p>Service coupler for water use</p>
	<p>Water flow control of service coupler for water use</p>		<p>Alternating current</p>
<p>W</p>	<p>Water</p>	<p>A</p>	<p>Air</p>
	<p>Protective earthing</p>		<p>Functional earthing</p>
	<p>Caution *The base color is yellow.</p>		<p>General warning sign *The base color is yellow.</p>
	<p>Generally prohibited activity</p>		<p>Disassembly, repair or modification prohibited</p>
	<p>Instructions for mandatory actions in general</p>		<p>Follow instructions for use *The base color is blue.</p>

1 General Information

	Type B Applied Parts	IPX 1	Classification of foot controller
	Drain valve		An autoclave symbol that indicates parts can be sterilized in an autoclave at temperatures up to 135°C
	Dental unit		Dental patient chair
	Name and address of the manufacturer		Manufacturing date and country
	Third-party certification stipulated in Medical Device Regulation: 2017/745 RoHS Directive 2011/65/EU		Separate collection of electrical and electronic equipment
	Medical device		European authorized representative
	Catalog number		Serial number
	Rated input		Rated voltage
	Electronic instructions for use		Swiss authorized representative

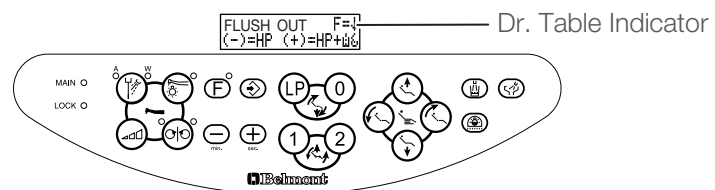

For the symbols used in the doctor table indicator, refer to section 5-1-3 (Function switch setup procedure).

1-13 Technical Description

The following are explained in the documents listed below:

Item	Document
How to install this product	Installation instructions
Wiring/plumbing	Installation instructions

2-1 Risk Level Interpretation

Precautions before use

Make sure to carefully read the Safety Precautions and Operating Precautions and use the product correctly.

These precautions are intended to ensure the safe use of the product and prevent harm or damage to users or other people.

According to the magnitude of harm and damage and the degree of urgency, an incident that may be caused by misuse of the product is classified into one of the following categories: CONTRAINDICATION, WARNING, and CAUTION.

All of these categories are important for safety. Always follow the instructions provided.

We assume no responsibility for any accident due to failure to follow the Safety Precautions or Operating Precautions even in the event of harm or damage to users or other persons.

In such case, users or other persons who use the product without observing the Safety Precautions and Operating Precautions are responsible for any harm or damage incurred.

The graphical symbols are explained in detail below.

Once you have fully understood this explanation, read the text.

2 Safety Consideration

Classification by degree of harm or damage and urgency

CONTRAINDICATION

Use of the product without regard to this indication will create a hazardous condition that may result in death or serious injury.



WARNING

Improper handling of the product without regard to this indication will create a hazardous condition that may result in death or serious injury.



CAUTION

Improper handling of the product without regard to this indication will create a potentially hazardous condition that may result in moderate or slight injury or property damage.

The following graphical symbols are used to explain your responsibilities for using the product safely:

Graphical symbols for prohibited activity



Generally prohibited activity



Disassembly, repair or modification prohibited

Graphical symbol for mandatory instructions



Instructions for mandatory actions in general

2-2 Safety Precautions

CONTRAINDICATION

Installing or transferring the product



Precautions regarding installation

Do not install the product near electromagnetic sources such as communication facilities or elevators.

Malfunction of this product may occur in the presence of electromagnetic interference waves.

Use and maintenance of the product



Do not use the equipment in an explosive atmosphere

Improper use in the presence of inflammable gases may cause injury or fire.

Use with caution in the presence of electromagnetic waves.

Do not use equipment generating electromagnetic waves, such as mobile phones, around this product.

Malfunction of this product may occur.

Be sure to turn off the main switch of the product when HF surgical equipment is in use.

Be sure to turn off the main switch when HF surgical equipment is in use because the noise generated from HF surgical equipment may cause incorrect operation of this product.



Never disassemble, repair or modify the product.

Individuals other than your local authorized Belmont dealer should not disassemble or repair this product.

This could lead to an accident, failure, electric shock, or fire.

Never modify the product as it is extremely dangerous.



WARNING

Installing or transferring the product



Precautions for installation

Ask your local authorized Belmont dealer to install the product.

Make sure to place the product on a firm and flat floor.

Placing the equipment on a non-flat floor may cause it to fall.

Be sure to ground the product securely. (Ask a professional to ground the product.)

Failure or electric leak may result in electric shock.

To avoid the risk of electric shock, this equipment must only be connected to a supply mains with protective earth.

Use and maintenance
of the product



WARNING

Keep moving parts of the product away from patients' and users' hands, fingers, and bodies.
Hands, fingers or bodies may become caught in the product, causing injury.

Do not wash the product with water.
This may cause failure or electric shock.

Prohibition of using this equipment adjacent to or stacked with other electronic equipment

Use of this equipment adjacent to or stacked with other equipment should be avoided because it could result in improper operation. If such use is necessary, this equipment and the other equipment should be observed to verify that they are operating normally.

Prohibition of placing portable RF communications equipment adjacent to this product

Portable RF communications equipment (including peripherals such as antenna cables and external antennas) should be used no closer than 30 cm (12 inches) to any part of this product, including cables specified by the manufacturer. Otherwise, degradation of the performance of this equipment could result.



Pay attention to patients and children.

Keep your eyes on the patient when this product is in use. Patients (especially children) may touch the control switch or system inadvertently, leading to an accident due to incorrect operation of the product.

Keep children away from this product except when giving treatment.

Remove the patient's glasses and any accessories (such as a necklace or bracelets) before treatment.

Failure to follow this instruction may hamper treatment and lead to an accident.

Pay close attention to a patient who has a cardiac pacemaker or defibrillator implanted.

If any abnormality occurs, immediately turn off the main switch and discontinue use of the product.

The product may affect the function of the pacemaker or defibrillator, leading to an accident.

Immediately wipe off any water spillage or leakage on the floor.

Decreased strength of the floor may cause the product to fall, leading to injury or damage to peripheral devices.

Use and maintenance of the product



WARNING

Clean the product thoroughly.

Poor cleaning may cause bacteria to grow, posing a health risk.

Ensure the maintenance of this product

Be sure to perform maintenance inspection before use (startup inspection to confirm that the product functions normally). Operation without performing maintenance inspection may result in injury and damage to peripheral equipment.

Prohibition of maintenance

During operation, repair and maintenance are prohibited.

Discontinue use of the product if it is broken.

In the case of a broken product, immediately discontinue use and turn off the main switch. Then, ask your local authorized Belmont dealer to repair the product.

Turn off the main switch during cleaning.

Failure to follow this instruction may cause electric shock or ignition. The product may also move unexpectedly, causing injury.

Action taken for power failure

If the chair stopped at elevated position, chair will not go down. Help a patient to get off from the chair while paying attention to avoid patient's injury. Pay attention the chair doesn't fall down. When power comes back after power failure, to avoid unexpected movement, follow below instructions.

- Turn off the main power switch on dental unit.
- Put the handpiece/syringe in the instrument holder/assistant holder.

Be sure to turn off the breaker for devices when the product is not used for a long period of time.

Make sure to turn off the breaker for devices in a clinic when the product is not used for a long time for reasons such as closing time and non-consultation day.

If the breaker is not turned off, a fire may be caused by a leakage of electricity due to insulation deterioration.

Use and maintenance
of the product



WARNING

Be sure to turn off the main switch upon completion of work or during work breaks

Be sure to turn off the main switch upon completion of work or during work breaks. This prevents incorrect operation due to accidental contact and associated hazards.

Excessive load must not be applied to the arm

Excessive load must not be applied to the doctor arm and assistant arm. The patient must not sit on the doctor arm or assistant arm. This may cause injury due to falling, or damage to peripheral devices.

Development of subcutaneous emphysema

Cooling air (alone or spray) is released from the chip of the handpiece (micromotor and air turbine/motor)/the nozzle chip of the syringe. This may cause the patient to develop subcutaneous emphysema, so use cooling air with caution.

Precautions for operating the chair and automatic operation

Before and during the chair operation, pay close attention to the operation range (seat raising/lowering direction, backrest lowering/raising direction, and legrest traveling direction [folding legrest chair only]), and ensure that the chair does not contact any body parts, hands or feet, or obstacles. Body parts, hands or feet, or objects may become caught in the chair, causing injury or damage to peripheral devices.

Before operating the chair, ensure that the patient is sitting in the correct position, and keep your eyes on him/her when the chair is in use.

CAUTION

Use and maintenance
of the product



Only experienced personnel should use this product
Only dentists or other dental professionals should use this product.

Do not hit or rub the product.

This may cause damage to the cover or operational failure.

Ensure that each part operates normally, with no abnormalities detected, before operation.

Always inspect the product for abnormal findings such as loose components, backlash, tilting, vibration, sound, abnormal temperature, or bad odors.

If you feel something is wrong, immediately discontinue use of the product and turn off the main switch. Then, contact your local authorized Belmont dealer.

Confirm safety before use

Before use, confirm that the parts are correctly and safely operating and that there are no obstacles around this product.

Read the accompanying documents for each device.

Before use, make sure to carefully read the instructions for use supplied with each device and use the device correctly.

Be sure to operate switches manually.

Make sure to operate the switches manually, except for the foot controller operated by the foot and stick switches. Failure to operate the switches by hand may cause damage or malfunction.

Carefully operate the switches to prevent a mistake.

The operator should pay close attention to people around the product and say something before operation to prevent any errors.

Immediately wipe off any drug solutions or water adhered to the product.

Control unit only:

Adherence of drug solutions or water to the control unit may cause operational failure or electrical leak. If drug solutions or water are adhered, immediately turn off the main switch and wipe them off with a dry, soft cloth.

Product:

Immediately wipe off drug solution when it comes into contact with this unit

Should drug solution or water come into contact with this unit, immediately wipe it off with a dry soft towel, etc. This could result in defective function or electric leakage as well as spotting or rusting.

Use and maintenance of the product



CAUTION

Precautions for cleaning the product exterior

If the exterior is excessively dirty, moisten a soft cloth with water containing approx. 10% of neutral detergent, and wipe the exterior with the cloth. Then, wipe it with a cloth moistened with water and dry it completely with a dry cloth.

Close the main water valve at the end of day.

To prevent the water leakage, make sure to close the main water valve at the end of day.

Pay attention during movement of the Doctor's table

Pay attention to surroundings when you move the Doctor's table. Injury by the tips of handpieces, etc., may occur. Be sure to move the Doctor's table by holding the handle of the unit.

Precautions when using the cart

When using the cart within the operation range of the chair, pay attention not to collide with person or chair. Contact with the tip of the handpiece may cause injury.

Do not sit or lean on the cart. Do not step on the cart base or cart hose. Otherwise, such actions may damage the hose or cause the cart to fall resulting in injury.

If you do not follow the instructions below, the product may be damaged or there is a risk that objects on the top will crash to the floor. (Do not move it in rough and vigorous way. /Hold the handle to move it. /Do not lift the cart with the handle.)

Precautions when using a handpiece

In the event of heat or smoky smell, stop using the handpiece, turn off the main switch, and contact your local authorized Belmont dealer. This may cause burns or have an adverse effect on the dental pulp.

Handling of the syringe and handpiece

Be careful not to drop the syringe and handpiece. Otherwise, it may break or the syringe and handpiece may deform.

Precautions for after using of the syringe

After use, wipe off syringe nozzle, body contaminated with blood or saliva and clean it with cleaning agent as necessary.

Sterilization with autoclave, be sure to use sterilization pouch.

For cleaning of other syringes, observe the instructions shown in the package inserts and instruction manuals included with the syringes. Before use, be sure to carefully read the package inserts and instruction manuals accompanying the various pieces of equipment (including optional articles) to ensure proper use.

Use and maintenance
of the product



CAUTION

Put on the cleaning gloves when detaching cuspidor bowl.
Cuspidor bowl is made of ceramic or glass that might cause injury when broken.

Precautions when using water other than tap water

The water unit is intended for use with tap water, purified water, distilled water, or pure water. Caution should be exercised as the use of water other than tap water, purified water, distilled water, or pure water (water through a sterilizer of water systems, etc.) may result in failure of equipment.

Clean and sterilize the HVE tip, syringe nozzle before use.

The HVE tip, syringe nozzle which contacts oral tissues, is provided without sterilization.

Cleaning and sterilization is necessary before use.

Pay attention to allergic reaction of a patient

While the HVE tip, syringe nozzle is placed in a patient mouse, pay attention to allergic reaction. If allergic reaction start to happen, immediately stop the usage of the HVE tip, syringe nozzle.

Precautions when moving a stool

Pay attention to surroundings when moving a stool. Not to hit the doctor table or a foot controller. This could cause malfunction or damage to the unit.

Combination with other devices

Use only our qualified other devices or equipment for this product to ensure the safety of product.

2 Safety Consideration

CAUTION

Safety precautions regarding water quality



Conduct flushing before treatment.

If this product is not used for a long time, water retained in ducts and in the water heater will be susceptible to bacterial growth. To provide safe treatment and operate the handpiece without any trouble, never forget to perform flushing (discharge) of the water lines before starting treatment.

To inhibit the growth of various bacteria, you are recommended to carry out flushing with fresh water at the end of treatment in the morning and evening.

E Type: Standard E

A Type: Option A

Standard length of time required for flushout of water lines in the unit	
Handpiece line Air turbine Air motor Micromotor Scaler Syringe (for both doctor / assistant)	About 40 seconds per each of micromotor, air turbine, air motor, scaler, and syringe. (About 40 seconds also in case of flushout of all of them in a batch.) ⚠ CAUTION Apply flushout to the scaler with the body kept fitted. Failure may result otherwise.
Cuspidor line Cupfiller (water heater) Bowl flush	About 5 minutes for cleaning water in cupfiller line.

Flushout procedure E	
Handpiece line Pick up one handpiece out of the holder, and hold it over the cuspidor bowl with the air turbine kept as it is and the contra angle connected to the air motor, micromotor. (*In case the flushout function is provided, pick up all the handpieces in a lump from the holder, and hold them on the cuspidor bowl.)	Short time flush out: For Flushing out the Handpiece water line only. As for flushout procedures, please refer to page 51 selection and operation of short time flush out.
Cuspidor line Cupfiller (water heater) Bowl flush	Long time flush out: For Flushing out the cupfiller and cuspidor bowl after handpiece flushout. As for flushout procedures, please refer to page 51 selection and operation of long time flush out.

Flushout procedure A	
Handpiece line Pick up one handpiece out of the holder, and hold it over the cuspidor bowl with the air turbine kept as it is and the contra angle connected to the air motor, micromotor. (*In case the flushout function is provided, pick up all the handpieces in a lump from the holder, and hold them over the cuspidor bowl.)	* Applicable when flush-out function was selected as optional. Turn the toggle switch on and flush out the handpiece.
Cuspidor line Cupfiller (water heater) Bowl flush	Repeat cupfilling a few times. (at least 3 times) Press the bowl flush switch and keep flushing the cuspidor bowl for 5 minutes.

NOTE

Without cuspidor bowl type: to discharge the water from the handpiece, use the basin or bucket.

2 Safety Consideration

Preparation for flushing

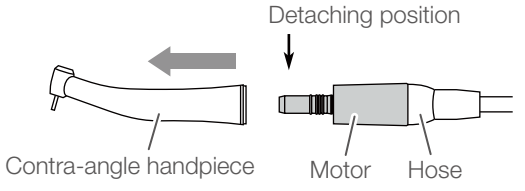
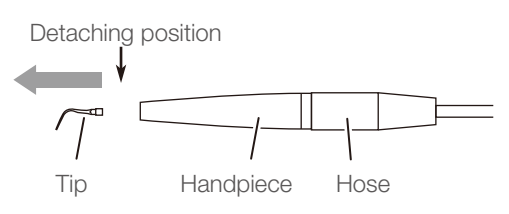
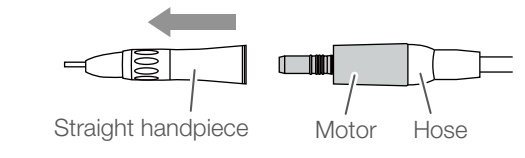
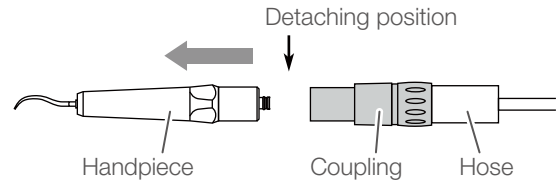
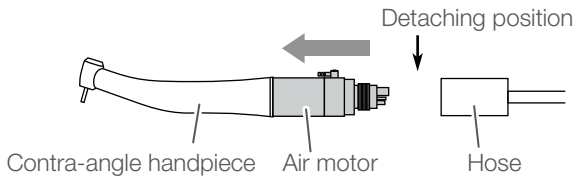
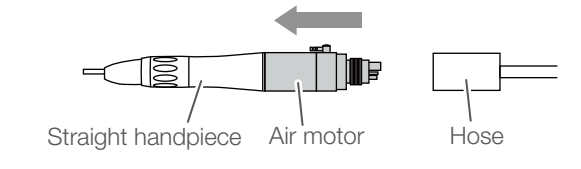
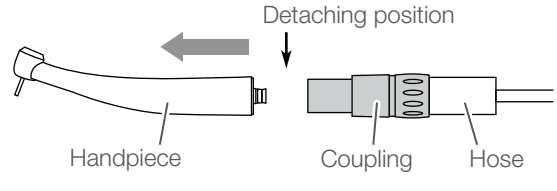
How to detach the handpieces	
Micromotor	Ultrasonic Scaler
 <p>Contra-angle handpiece Motor Hose</p>	 <p>Tip Handpiece Hose</p>
 <p>Straight handpiece Motor Hose</p>	Air Scaler
Air Motor	 <p>Handpiece Coupling Hose</p>
 <p>Contra-angle handpiece Air motor Hose</p>	Air Turbine
 <p>Straight handpiece Air motor Hose</p>	 <p>Handpiece Coupling Hose</p>

Use of flushing tray (option)	
For use	<ul style="list-style-type: none"> • See the instructions for use enclosed in the flusing tray. • For syringe, use the clip for water button.
Not for use	<ul style="list-style-type: none"> • Pick up all handpieces in clusters and hold them over the cuspidor bowl. • Flush the syringe while holding down the water button.

NOTICE

- After flushing, wipe off the extra moisture with the soft cloth.
- After flushing, residual air may be discharged when picking up the handpiece, but it is not a malfunction.
- Motor and coupling of KaVo and Bien Air have the water spray hole at the side, so turn their hole downward for flushing.
- For micromotor, detach the handpiece head (straight/contra-angle).
Flushing without taking off the handpiece head may lead to the following: water that got into the air piping of handpiece comes back when the handpiece is used.
- Flush the syringe with its head attached.

2 Safety Consideration

Over the patient

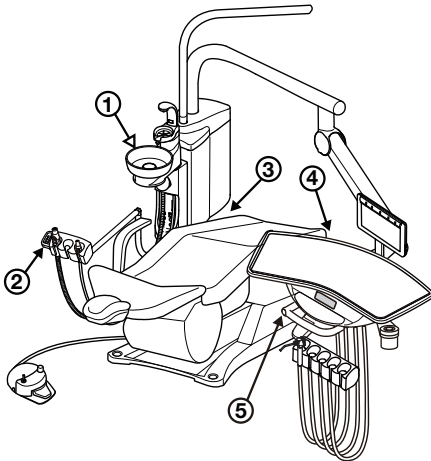

Cart

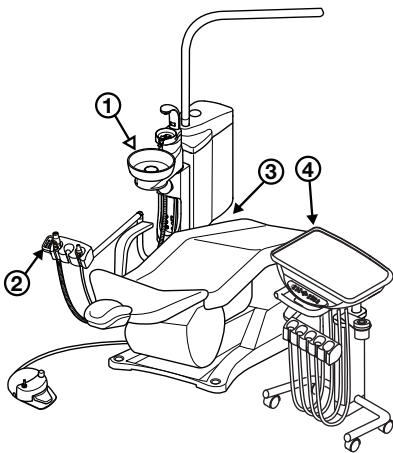

Points to remember when operating the product

Meaning of a symbol

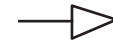
-  Point to remember
(locations requiring attention including moving parts, rotating parts, and detachable parts)
-  Point to remember where an emergency stop mechanism is available

Meanings of each point to remember

- ① Check the locking mechanism of the Cuspidor bowl.
Confirm that the switches for the chair operation are not activated when the Cuspidor bowl is turned in the direction of the chair. (Pedestal type)
- ② Pay attention to prevent contact with the assistant holder.
The upper part of the patient's body should not lean forward over the cuspidor unit.
- ③ Pay attention to prevent body parts or objects from becoming sandwiched between the cuspidor and the chair.
Before operating the chair, ensure that no hands, feet, or obstacles are placed between the cuspidor and the chair.
- ④ Pay attention to prevent contact of the chair with the doctor unit.
Do not place the doctor unit within the operational range of the chair.
- ⑤ Pay attention while moving the Doctor's table up & down
Do not move up & down the Doctor's table by without releasing the balance arm brake.

WARNING

When operating the chair, do not place the body parts or objects around the moving parts. This may cause injury.

2-3 EMC Information

This product complies with EMC Standard EN60601-1-2:2015 +AMD1:2021.

1. Precautions regarding EMC and compliance with accompanying documents

Medical electrical equipment requires special precautions regarding EMC and needs to be installed and put into service according to the EMC information provided in this booklet.

2. Effects of RF communication devices

Portable and mobile RF communication devices can affect medical electrical equipment.

3. Installation exclusion environment

Hospitals except for near active HF SURGICAL EQUIPMENT and the RF shielded room of an ME SYSTEM for magnetic resonance imaging, where the intensity of EM DISTURBANCES is high.

4. Electromagnetic emission declaration

Guidance and manufacturer's declaration—electromagnetic emissions			
CELEB is intended for use in the electromagnetic environment specified below. The customer or user of CELEB should ensure that it is used in such an environment.			
Emissions test	Compliance		Electromagnetic environment—guidance
	Japan	CE	
RF emissions CISPR 11	Group 1		CELEB only uses RF energy for its internal functions. Therefore, its RF emissions are very low and are not likely to cause any interference with nearby electronic equipment.
RF emissions CISPR 11	Class B		CELEB is suitable for use in all establishments, including domestic establishments and those directly connected to the public low-voltage power supply network that supplies buildings used for domestic purposes.
Harmonic emissions IEC 61000-3-2	Not applicable	Class A	
Voltage fluctuations/ Flicker emissions IEC 61000-3-3	Not applicable	Complies	



Use of this equipment adjacent to or stacked with other equipment should be avoided because it could result in improper operation. If such use is necessary, this equipment and the other equipment should be observed to verify that they are operating normally.

5. Electromagnetic immunity declaration 1

Guidance and manufacturer's declaration—electromagnetic immunity			
CELEB is intended for use in the electromagnetic environment specified below. The customer or user of CELEB should ensure that it is used in such an environment.			
Immunity test	IEC 60601 test level	Compliance level	Electromagnetic environment—guidance
Electrostatic discharge (ESD) IEC 61000-4-2	±8 kV contact ±15 kV air	±8 kV contact ±15 kV air	Flooring should be wood, concrete, or ceramic tiles. If the floor is covered with synthetic material, the relative humidity should be at least 30%.
Electrical fast transient/burst IEC 61000-4-4	±2 kV for power supply lines ±1 kV for input/output lines	±2 kV for power supply lines ±1 kV for input/output lines	The mains power quality should be that of a typical commercial or hospital environment.
Surge IEC 61000-4-5	±1kV differential mode ±2kV common mode	±1kV differential mode ±2kV common mode	The mains power quality should be that of a typical commercial or hospital environment.
Voltage dips, short interruptions and voltage variations on power supply input lines IEC 61000-4-11	0% Ut ; 0.5 cycles 0°, 45°, 90°, 135°, 180°, 225°, 270° and 315° 0% Ut ; 1 cycle and 70% Ut ; 25/30 cycles at 0°, single phase 0% Ut ; 250/300 cycles	0% Ut ; 0.5 cycles 0°, 45°, 90°, 135°, 180°, 225°, 270° and 315° 0% Ut ; 1 cycle and 70% Ut ; 25/30 cycles at 0°, single phase 0% Ut ; 250/300 cycles	The mains power quality should be that of a typical commercial or hospital environment. If the user of CELEB requires continued operation during mains power interruptions, it is recommended that CELEB be powered from an uninterruptible power supply or a battery.
Power frequency (50/60 Hz) magnetic field IEC 61000-4-8	30A/m	30A/m	Power frequency magnetic fields should be at levels characteristic of a typical location in a typical commercial or hospital environment.
Proximity magnetic fields IEC 61000-4-39	134.2kHz 65A/m, Pulse Modulation 2.1kHz 13.56MHz 7.5A/m, Pulse Modulation 50kHz	134.2kHz 65A/m, Pulse Modulation 2.1kHz 13.56MHz 7.5A/m, Pulse Modulation 50kHz	Proximity magnetic fields should be at levels characteristic of a typical location in a professional healthcare facility environment.
Note Ut is the AC mains voltage prior to the application of the test level.			

6. Electromagnetic immunity declaration 2

Guidance and manufacturer's declaration—electromagnetic immunity			
CELEB is intended for use in the electromagnetic environment specified below. The customer or user of CELEB should ensure that it is used in such an environment.			
Immunity test	IEC 60601 test level	Compliance level	Electromagnetic environment —guidance
Conducted RF IEC 61000-4-6	3V 0.15MHz-80MHz 6V 0.15MHz-80MHz in ISM bands and amateur radio bands	3V 0.15MHz-80MHz 6V 0.15MHz-80MHz in ISM bands and amateur radio bands	Warning: Portable RF communications equipment (including peripherals such as antenna cables and external antennas) should be used no closer than 30 cm (12 inches) to any part of CELEB, including cables specified by the manufacturer. Otherwise, degradation of the performance of this equipment could result.
Radiated RF IEC 61000-4-3	3V/m 80MHz-2.7GHz 80% AM (1 kHz)	3V/m 80MHz-2.7GHz 80% AM (1 kHz)	
Near electromagnetic field caused by RF wireless communication devices IEC61000-4-3	See the table on the next page	See the table on the next page	

7. Essential performance

Unless operated by the chair control switch, the chair will not make any movements. Unless operated by the foot controller, the handpiece will not move except for sounding a buzzer and switching the indicator on/off.

Loss or decline of essential performance may cause the chair or handpiece to move unexpectedly, causing harm or damage to the patient, operator or people or objects around the patient or operator.



Portable RF communications equipment (including peripherals such as antenna cables and external antennas) should be used no closer than 30 cm (12 inches) to any part of CELEB including cables specified by the manufacturer. Otherwise, degradation of the performance of this equipment could result.

2 Safety Consideration

Near electromagnetic field caused by RF wireless communication devices

Test frequency (MHz)	Modulation	IEC 60601 test level	IEC 60601 compliance level
385	Pulse modulation ^{a)} 18Hz	27V/m	27V/m
450	Frequency modulation ±5kHz shift 1kHz sine wave	28V/m	28V/m
710 745 780	Pulse modulation ^{a)} 217Hz	9V/m	9V/m
810 870 930	Pulse modulation ^{a)} 18Hz	28V/m	28V/m
1720 1845 1970	Pulse modulation ^{a)} 217Hz	28V/m	28V/m
2450	Pulse modulation ^{a)} 217Hz	28V/m	28V/m
5240 5500 5785	Pulse modulation ^{a)} 217Hz	9V/m	9V/m
Note a) The carrier is modulated by a square wave with a 50% duty cycle.			

2-4 Compatible Handpieces

The following handpieces are compatible with this product:

Syringe	SYR-20	
	77 type 3Way	
	DCI 3Way	
	LUZZANI Minilight 3Way	
	LUZZANI Minilight 6Way	
Air turbine * Not optic turbine for A-type	NSK Ti-Max Z Series	
	NSK Ti-Max X Series	
	NSK S-Max M Series	
	NSK Pana Max Plus Series	
Air motor	NSK Pana Max 2 Series	
	NSK EX-203 Series	
	NSK FX205 Series	
	NSK S-Max M205 Series	
Micromotor * E-Type only	NSK Ti-Max X205 Series	
	BIEN AIR MX2	
	BIEN AIR MCX / DMCX PCB	
	NSK Ti-Max NLX plus / NLX PCB	
Contra-angle Straight	NSK Ti-Max NLX nano / NLX PCB	
	NSK NBX iMD PCB	
	Contra-angle	Straight
	NSK Ti-Max Z Series	NSK EX-6 Series
	NSK Ti-Max X Series	NSK Ti-Max X65 Series
	NSK S-Max M Series	NSK S-Max M65 Series
	NSK FX Series	NSK FX65 Series
NSK EX Series	BIEN AIR PM 1:1	
Scaler	BIEN AIR CA 1:1	
	NSK VARIOS 170	
	NSK VARIOS 170 LUX	
	DENTSPLY CAVITRON SCALER (TYPE G139)	
	SATELEC SP4055 NEWTRON / SP4055 NEWTRON Module	
	SATELEC SP4055 NEWTRON LED / SP4055 NEWTRON Module with LED Drive Board	
	ACTEON XINETIC	
	EMS PIEZON NO PAIN	
Curing light	EMS PIEZON NO PAIN LED	
	SATELEC MINI LED STD OEM	

Note
Series of Air turbine, Air motor, and Contra-angle/ Straight have been confirmed the combination of this products. Using the Series mentioned above is recommended.

2-5 Compatible Dental Chairs

The following Dental Chairs are compatible with this product:

Dental Chair	CELEB CHAIR (EURUS TYPE)
	CELEB CHAIR

2-6 Compatible Dental Lights

The following dental lights are compatible with this product:

Dental Light	EURUS LIGHT
	900 Dental Light (Type 920/Type D200)
	300 Dental Light (Type 320S)

2-7 Compatible Medical devices

The following Medical devices are compatible with this product:

DURR	CAS1 Combi-Separator
	CS1 Combi-Sepamatic
METASYS	MST1
	MST1 ECO Light
	COMPACT Dynamic
	WEK
	WEK Light

3-1 Operating Precautions

Do not apply heat to the product.

This may cause deterioration or discoloration.

Discoloration of resin

Resin materials are used in external components of the product. Carefully selected materials are used; however, discoloration may occur for reasons such as natural deterioration or the adherence of drug solutions.

To ensure use of the product for as long as possible, immediately wipe off any drug solutions adhered and avoid sunlight.

Check the operation of the compressor.

This product will not work unless air is supplied. Switch on the compressor before operating this product.

Pay attention to prevent the use of water other than tap water.

This product is intended for use with tap water, purified water, distilled water, or pure water; use of water other than those mentioned above may lead to failure.

If the product breaks down due to the use of unspecified water, it will not be covered by the guarantee.

Use this product only for dental treatment.

This product is a dental unit and patient chair used for dental treatment. Only a dentist and dental staff are allowed to use this product.

In the case of malfunction and contact information

In the case of any problems, discontinue use, turn off the main switch and contact your local authorized Belmont dealer.

Action to take in the case of a water leak

In the event of a water leak, close the main water valve, turn off the main switch and breaker for devices used in the clinic, and contact your local authorized Belmont dealer.

4-1 Technical Data

4-1-1 Specification Variations

Abbreviation

Chair Mount Over the Patient Type	CM
Chair Mount Cart Type	CM CT
Pedestal Over the Patient Type	PD
Pedestal Cart Type	PD CT

		CM	CM CT	PD	PD CT
Dental chair	CELEB CHAIR (EURUS TYPE)	<input type="radio"/>	<input type="radio"/>	<input type="radio"/>	<input type="radio"/>
	CELEB CHAIR	<input type="radio"/>	<input type="radio"/>		
Dental light	EURUS LIGHT	<input type="radio"/>	<input type="radio"/>	<input type="radio"/>	<input type="radio"/>
	900 Dental Light (Type 920/Type D200)	<input type="radio"/>	<input type="radio"/>	<input type="radio"/>	<input type="radio"/>
	300 Dental Light (Type 320S)	<input type="radio"/>	<input type="radio"/>		
Instrument delivery	Holder	<input type="radio"/>	<input type="radio"/>	<input type="radio"/>	<input type="radio"/>
	Place holder	<input type="radio"/>	<input type="radio"/>	<input type="radio"/>	<input type="radio"/>
	Rod	<input type="radio"/>		<input type="radio"/>	
Control panel	E (electric) type	<input type="radio"/>	<input type="radio"/>	<input type="radio"/>	<input type="radio"/>
	A (air) type	<input type="radio"/>	<input type="radio"/>	<input type="radio"/>	<input type="radio"/>
Food controller	SE type	<input type="radio"/>	<input type="radio"/>	<input type="radio"/>	<input type="radio"/>
	A2 type	<input type="radio"/>	<input type="radio"/>	<input type="radio"/>	<input type="radio"/>

4-1-2 Chair Mount Over the Patient Type

Catalog number	AU-CEA-CO*/AU-CEE-CO* AU-CEA-CR*/AU-CEE-CR* (* represents single or multiple strings or numbers.)
Classification for protection against electric shock	Class I Equipment
Classification according to the degree of protection against electric shock	Type B Applied Parts (handpiece)
Classification according to the degree of protection against ingress of water or particulate matter	Foot controller IPX1
Rated voltage	AC230 V
Power frequency	50 Hz
Power input	1.6 A (Dental unit) 5.0 A (Dental unit with Chair)
Fuse	Primary circuit: 5A/250V Low breaking capacity Operating speed: Time lag Size: 5.2 × 20 mm
Weight	99.5Kg (without dental light)
Weight limit	Doctor table 3 kg Sub-tray of doctor table (Rod) 1.5 kg CELEB CHAIR (EURUS TYPE) (maximum patient mass;) 200 kg CELEB CHAIR (maximum patient mass;) 150 kg
Air supply	
Main air pressure	0.5MPa
Filter mesh size	50µm
Minimum flow rate	100L/min
Air purity-class	Particle class 2/Humidity class 4/ Oil content class 2
Water supply	
Main water pressure	0.2MPa
Filter mesh size	100µm
Minimum flow rate	6L/min
water hardness limit	Less than 2,14 mmol/l
pH limits	6.5 to 8.5
Suction system	Semi-dry system
Suction air volume flow rate	Type 1: high-volume

4 Product Specifications

Usage environment

Temperature 0°C to 40°C
 Humidity 10% to 95% (No condensation)
 Atmospheric pressure 700 to 1060 hPa

Transportation/storage environment

Temperature -20°C to 70°C
 Humidity 10% to 95% (No condensation)
 Atmospheric pressure 700 to 1060 hPa

Adaptation to high-oxygen environment

The product is not suitable for use in a high-oxygen environment.

Dimensional drawing (standard values are provided)

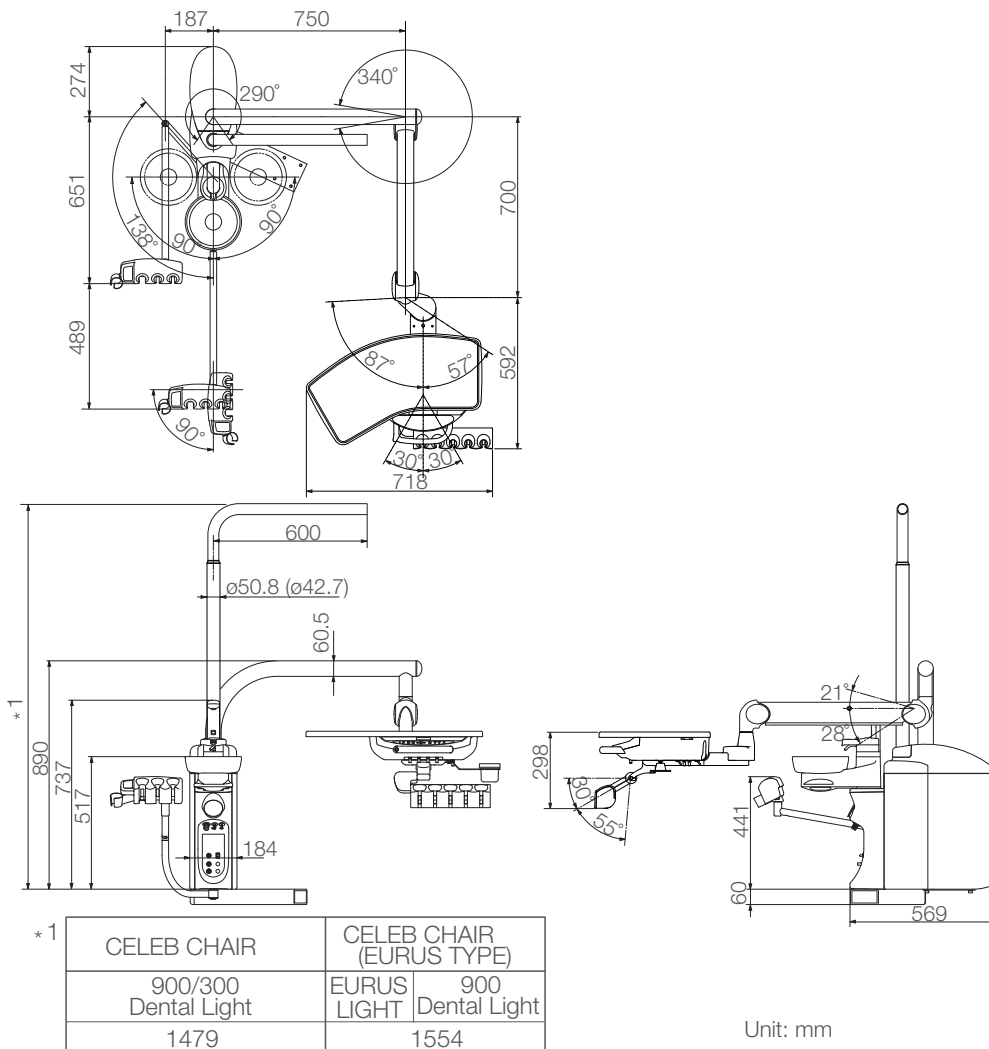

Unit: mm
 Tolerance in dimensions: ±10%

4-1-3 Chair Mount Cart Type

Catalog number	AU-CEA-CC* / AU-CEE-CC* (Cart) AU-CEA-CS* / AU-CEE-CS* (Cuspidor) (* represents single or multiple strings or numbers.)
Classification for protection against electric shock	Class I Equipment
Classification according to the degree of protection against electric shock	Type B Applied Parts (handpiece)
Classification according to the degree of protection against ingress of water or particulate matter	Foot controller IPX1
Rated voltage	AC230 V
Power frequency	50 Hz
Power input	1.6 A (Dental unit) 5.0 A (Dental unit with Chair)
Fuse	Primary circuit: 5A/250V Low breaking capacity Operating speed: Time lag Size: 5.2 × 20 mm
Weight	99.5Kg (without dental light)
Weight limit	Doctor table 3 kg CELEB CHAIR (EURUS TYPE) (maximum patient mass;) 200 kg CELEB CHAIR (maximum patient mass;) 150 kg
Air supply	
Main air pressure	0.5MPa
Filter mesh size	50µm
Minimum flow rate	100L/min
Air purity-class	Particle class 2/Humidity class 4/ Oil content class 2
Water supply	
Main water pressure	0.2MPa
Filter mesh size	100µm
Minimum flow rate	6L/min
water hardness limit	Less than 2,14 mmol/l
pH limits	6.5 to 8.5
Suction system	Semi-dry system
Suction air volume flow rate	Type 1: high-volume

4 Product Specifications

Usage environment

Temperature 0°C to 40°C
 Humidity 10% to 95% (No condensation)
 Atmospheric pressure 700 to 1060 hPa

Transportation/storage environment

Temperature -20°C to 70°C
 Humidity 10% to 95% (No condensation)
 Atmospheric pressure 700 to 1060 hPa

Adaptation to high-oxygen environment

The product is not suitable for use in a high-oxygen environment.

Dimensional drawing (standard values are provided)

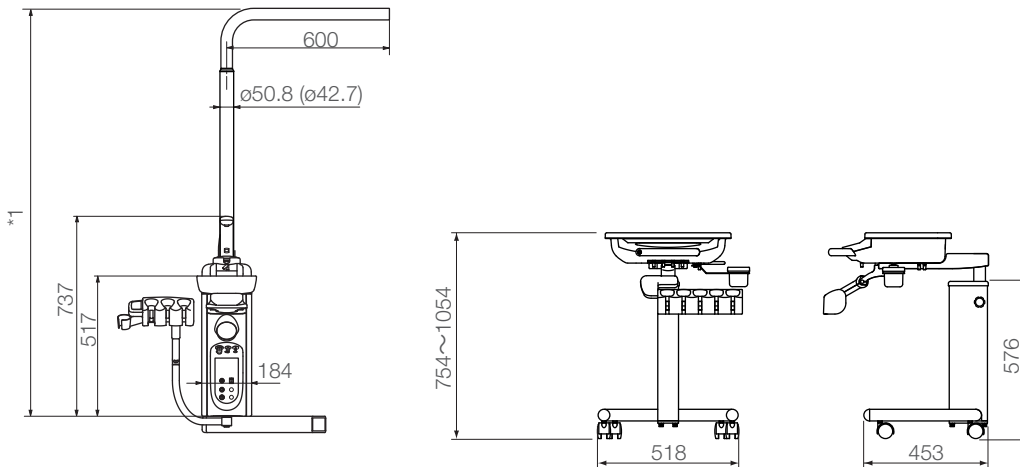
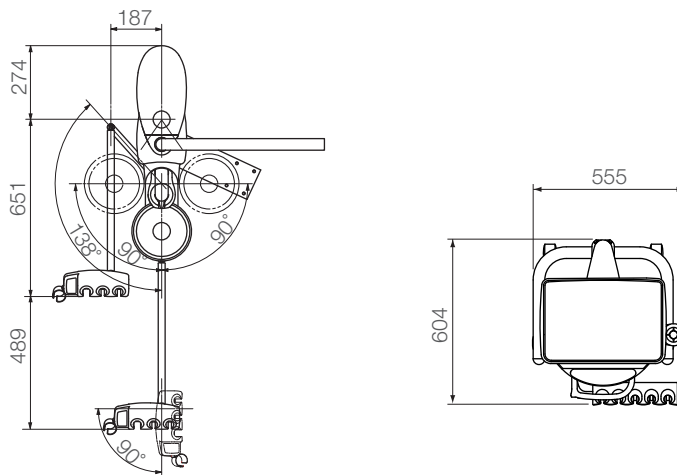

* 1	CELEB CHAIR	CELEB CHAIR (EURUS TYPE)	
	900/300 Dental Light	EURUS LIGHT	900 Dental Light
	1479	1554	

Unit: mm
 Tolerance in dimensions: ±10%

4-1-4 Pedestal Over the Patient Type

Catalog number	AU-CEA-PO* / AU-CEE-PO* AU-CEA-PR* / AU-CEE-PR* (* represents single or multiple strings or numbers.)
Classification for protection against electric shock	Class I Equipment
Classification according to the degree of protection against electric shock	Type B Applied Parts (handpiece)
Classification according to the degree of protection against ingress of water or particulate matter	Foot controller IPX1
Rated voltage	AC230 V
Power frequency	50 Hz
Power input	1.6 A (Dental unit) 5.0 A (Dental unit with Chair)
Fuse	Primary circuit: 5A/250V Low breaking capacity Operating speed: Time lag Size: 5.2 × 20 mm
Weight	111.7Kg (without dental light)
Weight limit	Doctor table 3 kg Sub-tray of doctor table (Rod) 1.5 kg CELEB CHAIR (EURUS TYPE) (maximum patient mass;) 200 kg CELEB CHAIR (maximum patient mass;) 150 kg
Air supply	
Main air pressure	0.5MPa
Filter mesh size	50µm
Minimum flow rate	100L/min
Air purity-class	Particle class 2/Humidity class 4/ Oil content class 2
Water supply	
Main water pressure	0.2MPa
Filter mesh size	100µm
Minimum flow rate	6L/min
water hardness limit	Less than 2,14 mmol/l
pH limits	6.5 to 8.5
Suction system	Semi-dry system
Suction air volume flow rate	Type 1: high-volume

4 Product Specifications

Usage environment

Temperature 0°C to 40°C
 Humidity 10% to 95% (No condensation)
 Atmospheric pressure 700 to 1060 hPa

Transportation/storage environment

Temperature -20°C to 70°C
 Humidity 10% to 95% (No condensation)
 Atmospheric pressure 700 to 1060 hPa

Adaptation to high-oxygen environment

The product is not suitable for use in a high-oxygen environment.

Dimensional drawing (standard values are provided)

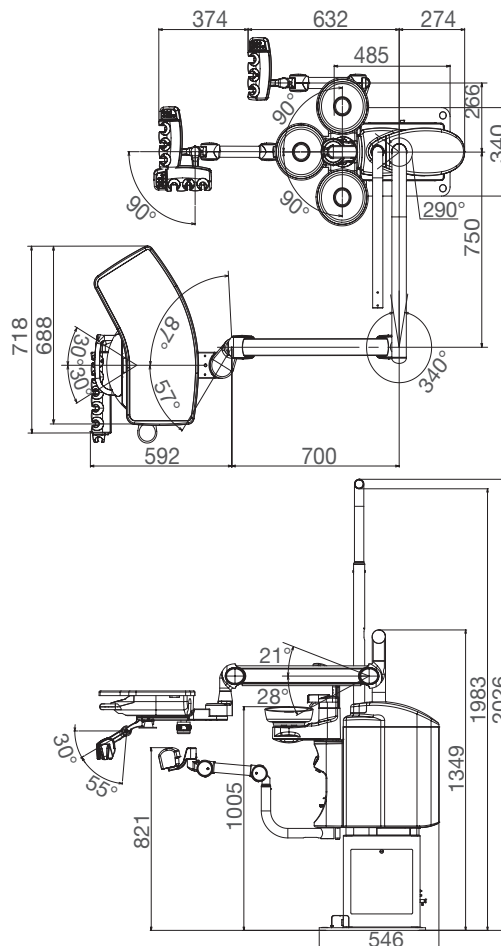

Unit: mm
 Tolerance in dimensions: ±10%

4-1-5 Pedestal Cart Type

Catalog number	AU-CEA-PC* / AU-CEE-PC* (Cart) AU-CEA-PS* / AU-CEE-PS* (Cuspidor) (* represents single or multiple strings or numbers.)
Classification for protection against electric shock	Class I Equipment
Classification according to the degree of protection against electric shock	Type B Applied Parts (handpiece)
Classification according to the degree of protection against ingress of water or particulate matter	Foot controller IPX1
Rated voltage	AC230 V
Power frequency	50 Hz
Power input	1.6 A (Dental unit) 5.0 A (Dental unit with Chair)
Fuse	Primary circuit: 5A/250V Low breaking capacity Operating speed: Time lag Size: 5.2 × 20 mm
Weight	111.7Kg (without dental light)
Weight limit	Doctor table 3 kg CELEB CHAIR (EURUS TYPE) (maximum patient mass;) 200 kg
Air supply	
Main air pressure	0.5MPa
Filter mesh size	50µm
Minimum flow rate	100L/min
Air purity-class	Particle class 2/Humidity class 4/ Oil content class 2
Water supply	
Main water pressure	0.2MPa
Filter mesh size	100µm
Minimum flow rate	6L/min
water hardness limit	Less than 2,14 mmol/l
pH limits	6.5 to 8.5
Suction system	Semi-dry system
Suction air volume flow rate	Type 1: high-volume

4 Product Specifications

Usage environment

Temperature 0°C to 40°C
 Humidity 10% to 95% (No condensation)
 Atmospheric pressure 700 to 1060 hPa

Transportation/storage environment

Temperature -20°C to 70°C
 Humidity 10% to 95% (No condensation)
 Atmospheric pressure 700 to 1060 hPa

Adaptation to high-oxygen environment

The product is not suitable for use in a high-oxygen environment.

Dimensional drawing (standard values are provided)

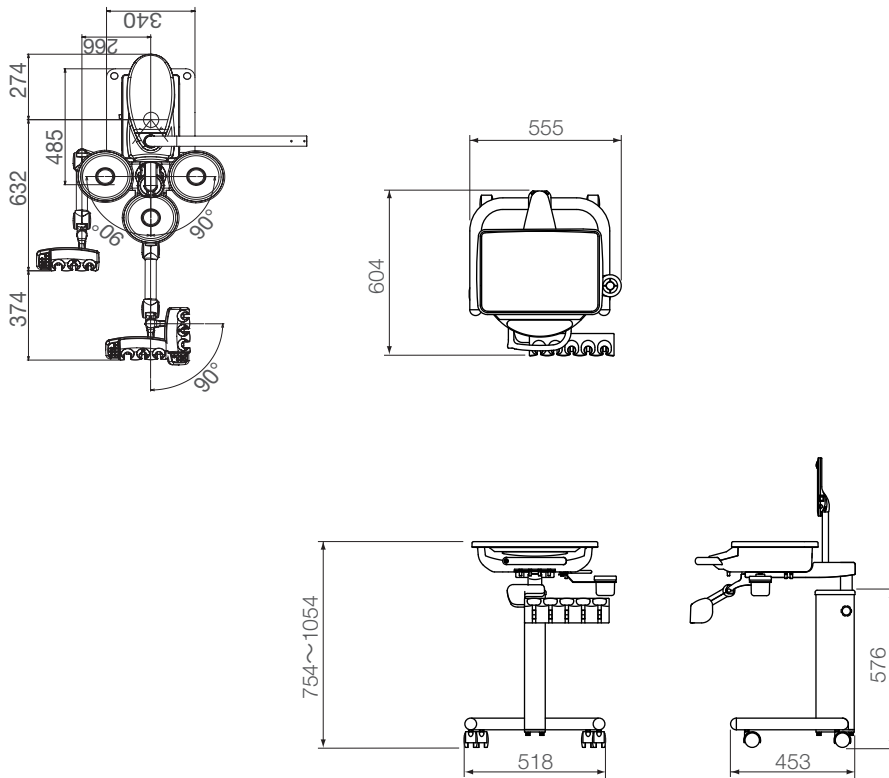

Unit: mm
 Tolerance in dimensions: ±10%

4 Product Specifications

4-2 Overview and Major Components

4-2-1 Over the Patient

Chair Mount

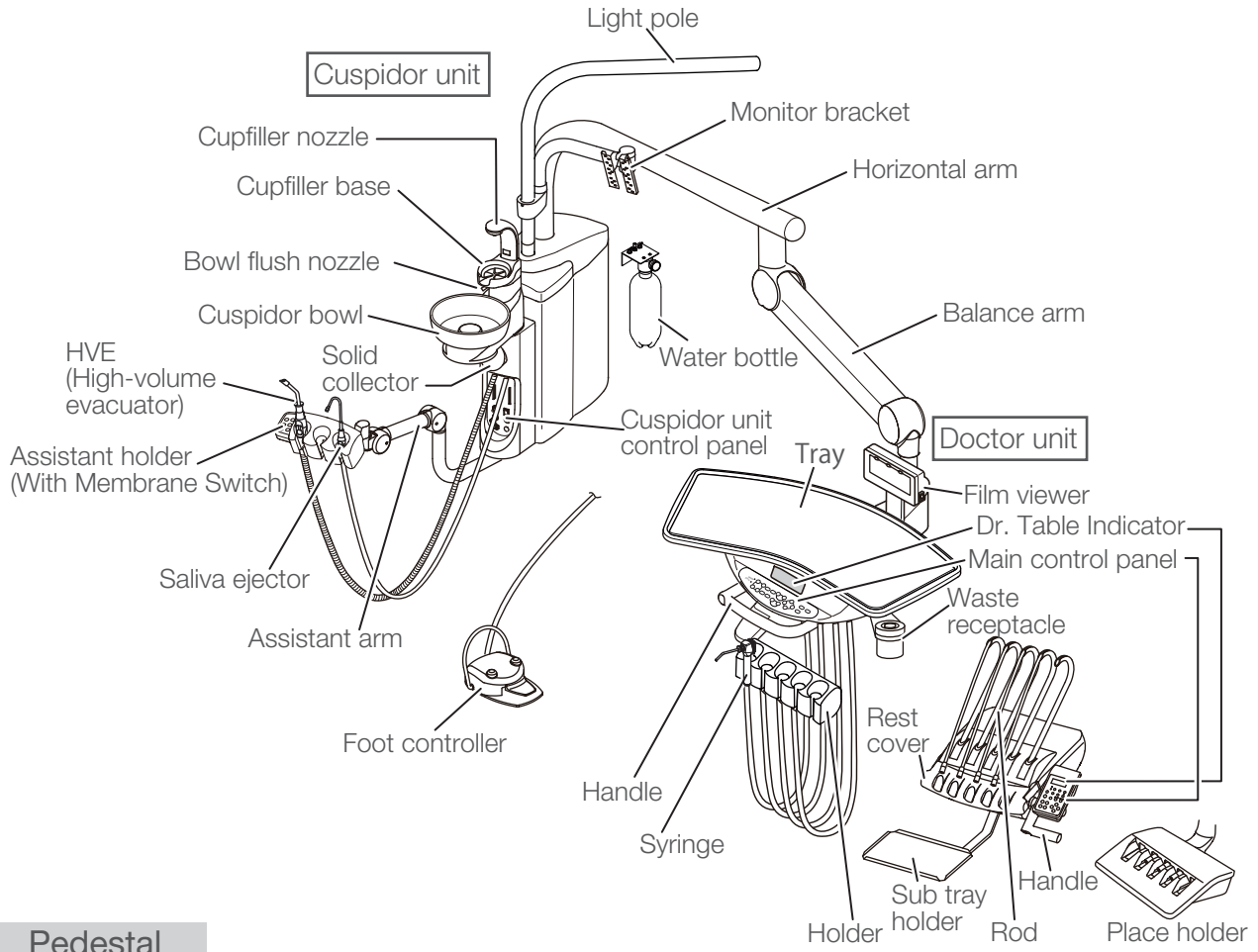

Pedestal

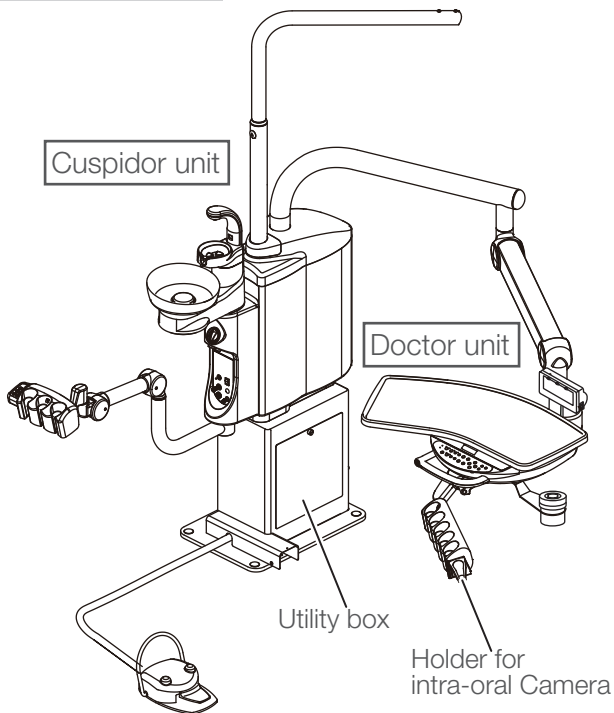

Junction unit

Built-in chair type

- CELEB CHAIR -

Junction cover

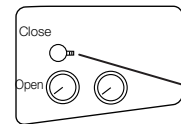

Drain valve knob

- CELEB CHAIR (EURUS TYPE)

- Junction cover

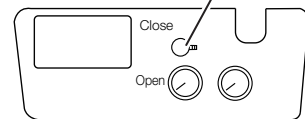
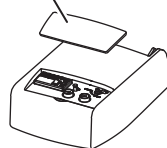

External type

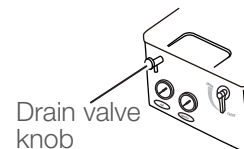
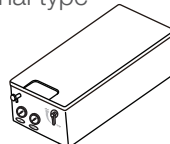

Drain valve knob

4 Product Specifications

4-2-2 Cart

Chair Mount

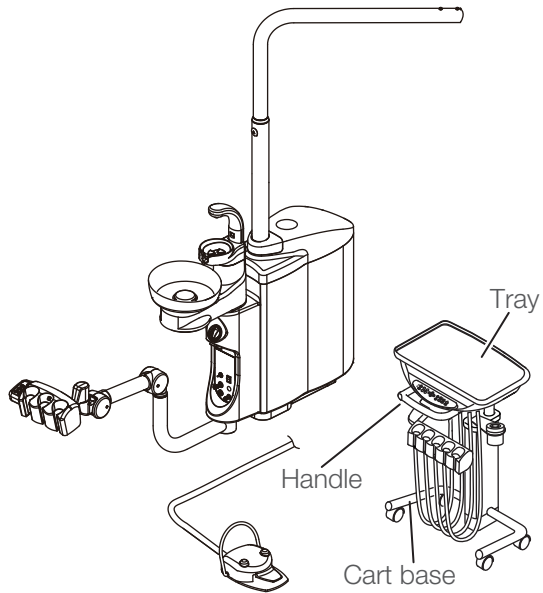

Pedestal

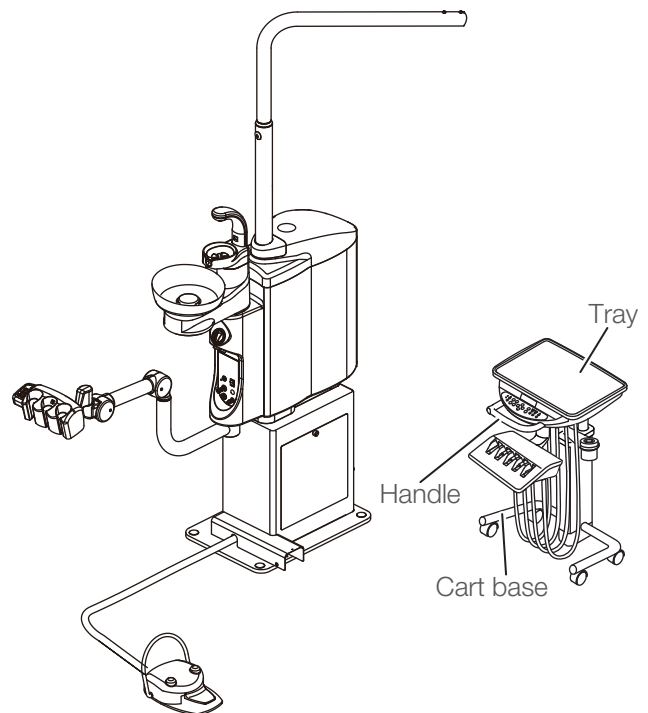

5-1 Doctor unit section

5-1-1 Holder type

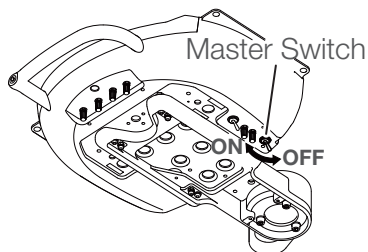

Master switch

Turn on the master switch located under the right hand side of the doctor table, the power indicator on the main control panel will then illuminate green.

Turn off the master switch after daily operation and for long term interval.

Main control panel

A Spec. control panel **A**

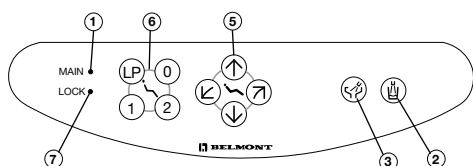

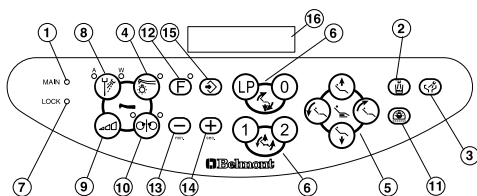

E Spec. control panel **E**

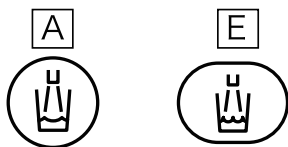

- ① Power indicator
- ② Cupfiller switch
- ③ Bowl flush switch
- ④ Handpiece light switch (on/off)
- ⑤ Chair manual control switches
- ⑥ Chair auto mode switches
- ⑦ Safety lock indicator
- ⑧ Coolant water ON/OFF switch
- ⑨ Electric motor speed setting switch
- ⑩ Electric motor direction control switch
- ⑪ Dental light ON/OFF switch
- ⑫ Function Switch
- ⑬ Decreasing Switch
- ⑭ Increasing Switch
- ⑮ Store Switch
- ⑯ Function Indicator

Cupfiller switch **A****E**



Momentarily press the cupfiller switch (), water will come out from the cupfiller nozzle for 3 seconds and stops automatically. Also the bowl flush starts and will run for 6 seconds and stops automatically.

While the cupfiller is working, by momentarily pressing the cupfiller switch () the cupfilling will cancel.

Also, when the cupfiller starts, the cuspidor water flushes 6 seconds and stops automatically. (Synchronized Bowl Flush)

Note :The cupfiller water volume can be adjusted by the cupfiller flow control knob located inside the cuspidor body.

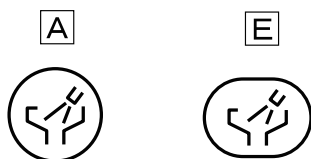

Bowl flush switch [A] [E]

Momentarily press the bowl flush switch (A), water flushes for 6 seconds and stops automatically. (Timer mode) Press the bowl flush switch for 2 seconds, water flushes continuously. (Continuous mode) While the bowl flush is working by momentarily pressing the bowl flush switch (E), the bowl flush will stop.

Note : CELEB can be set to timer mode (standard setting) and continuous mode for bowl flush.

The bowl flush water volume can be adjusted by the bowl flush flow control knob located inside the cuspidor body.

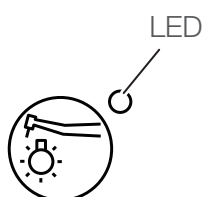

Handpiece light switch (on/off) [E]

Pick up the fiber optic handpiece from the holder, momentarily press the light pack switch (E), the indicator illuminates in green and the fiber optic power turns on.

To switch off the light pack simply press the light pack switch again.

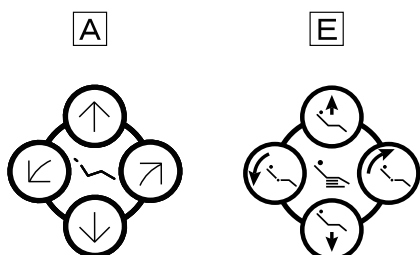

Chair manual control switches [A] [E]

Seat Lifting-----Press the (A) switch until the seat is lifted up to the desired position.

Seat Lowering -----Press the (E) switch until the seat is lowered to the desired position.

Backrest Reclining ----Press the (E) switch until the backrest is reclined to the desired position.

Backrest Raising -----Press the (E) switch until the backrest is raised up to the desired position.

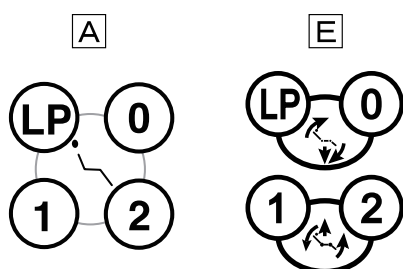

Chair auto mode switches [A] [E]

Preset operation

Momentarily press the preset-1 switch (1), the chair moves to the preset 1 position and stops automatically.

Preset 2 position operated by the preset switch (2).

Note : For preset position adjustment refer to chair Manual.

Automatic return operation

Momentarily press the auto return switch (0), the chair returns to the initial position (the seat is the lowest position and the backrest is the upright position) and stops automatically.

Last position memory operation

Momentarily press the last position memory switch (LP), at the treatment position, the backrest raises up to the rinsing position (upright position) and stops automatically.

Momentarily press the last position memory switch (LP) again, the backrest returns to the previous treatment position and stops automatically.

Emergency stop (Safety stop)

During automatic movements (preset, auto return and last position memory), by momentarily pressing any chair control switch this will cancel the automatic movement immediately.

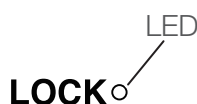

Chair lock indicator A E

The safety lock indicator illuminates amber when the safety lock device is working.

Note: Please refer to 5-5. Lock function



Coolant water ON/OFF switch E

When a handpiece is picked up and this switch is pressed, both LED A (air) and LED W (water) lights up, the coolant water and air comes out from the handpiece. In case of air motor or air turbine, switching between spray (both of LED A and LED W are lit) and OFF occurs when this switch is pressed. In case of electric scaler, switching between water only (LED W is lit) and OFF occurs when this switch is pressed, regardless of the mode.

In case of micromotor, either the 2-mode or the 4-mode can be selected by mode select setup. When this switch is pressed in the 2-mode setup, switching between spray and OFF occurs. In case of 4-mode setup, switching occurs in the sequence indicated below each time when this switch is pressed: Spray to Water only to Air only to OFF.

As for the mode setting, please refer to 5-1-3. Function switch setup procedure.

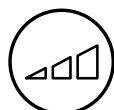



Electric motor speed set switch E

Two different modes, limit mode and preset mode, are available as micromotor rotation speed modes. Pressing this switch each time changes the speed mode: Limit speed -> SET1 -> SET2 -> SET3 -> Limit speed.

The indicator indicates the selected mode.

1) Switching to limit rotation speed (limit mode)

Pick up the micromotor from the holder, and press this switch (), to select limit mode. For selecting the upper limit in the limit mode, press either plus (), switch or minus (), switch. The upper limit of the micromotor rotation speed changes in three steps (or 5 steps).

- Upper limit of rotation speed in case of 3 steps:

10000/20000/40000 min⁻¹(rpm)



- Upper limit of rotation speed in case of 5 steps:

5000/10000/20000/30000/40000 min⁻¹(rpm)

As for the 5 step setting, please refer to 5-1-3. Function switch setup procedure.

2) Switching to preset rotation speed (preset mode)

Pick up the micromotor out of the holder, press this switch (), and then select preset mode (SET1 to 3).

The rotation speed in this mode can be changed by pressing plus () switch or minus () switch.

Press store switch () for storing the changed rotation speed.

When the foot controller is depressed upon selection of preset mode (SET1 to 3), the micromotor runs at the fixed rotation speed indicated on the indicator.

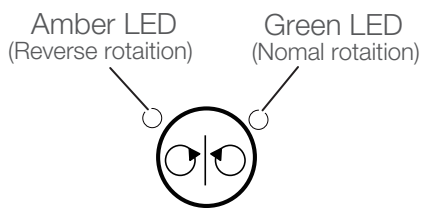

Micromotor rotation switch for normal/reverse E

After picking up the electric motor from the holder, the electric motor rotation direction can be changed by momentarily pressing this switch () the rotation direction will be indicated by the amber and green LEDs.

Indicator in green :Normal rotation

Indicator in amber :Reverse rotation

Note: Do not change the electric motor direction while the motor is running.

When the electric motor with setting reverse rotation is returned the holder and picked up again, a buzzer sounds.



Dental light ON/OFF switch E

Switch for on/off the dental light.



Function switch E

Use this switch for setting various working conditions.

5-1-2 Rod type

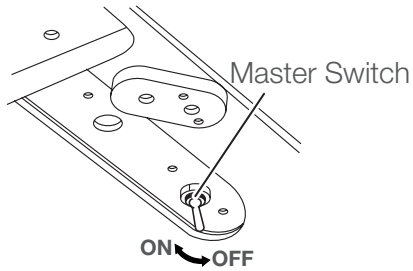

Master switch

Turn on the master switch located on the right hand side (facing) under the doctor table, the power indicator on the main control panel illuminates in green.

7 A Spec. control panel **A**

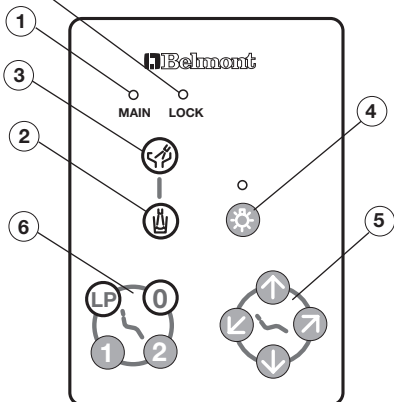

Main control panel

- ① Power indicator
- ② Cupfiller switch
- ③ Bowl flush switch
- ④ Light pack switch
- ⑤ Chair manual control switches
- ⑥ Chair auto mode switches
- ⑦ Safety lock indicator
- ⑧ Coolant water ON/OFF switch
- ⑨ Electric motor speed setting switch
- ⑩ Electric motor direction control switch
- ⑪ Dental Light Switch
- ⑫ Function Switch
- ⑬ Decreasing Switch
- ⑭ Increasing Switch
- ⑮ Store Switch
- ⑯ Function Indicator

E Spec. control panel **E**

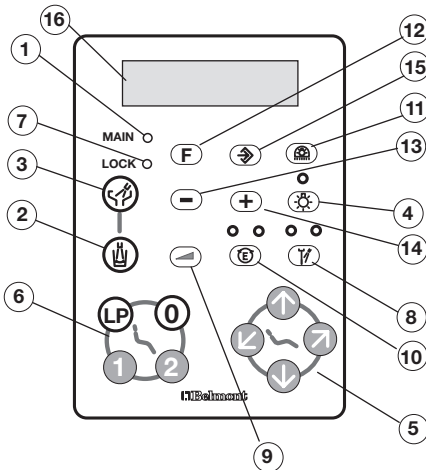

Cupfiller switch **A E**

Momentarily press the cupfiller switch (), water will come out from the cupfiller nozzle for 3 seconds and stops automatically. Also the bowl flush starts and will run for 6 seconds and stops automatically.

While the cupfiller is working, by momentarily pressing the cupfiller switch () the cupfilling will cancel.



Also, when the cupfiller starts, the cuspidor water flushes 6 seconds and stops automatically. (Synchronized Bowl Flush)

Note :The cupfiller water volume can be adjusted by the cupfiller flow control knob located inside the cuspidor body.





Bowl flush switch A E

Momentarily press the bowl flush switch (), water flushes for 6 seconds and stops automatically. (Timer mode) Press the bowl flush switch for 2 seconds, water flushes continuously. (Continuous mode) While the bowl flush is working by momentarily pressing the bowl flush switch (), the bowl flush will stop.

Note : CELEB can be set to timer mode (standard setting) and continuous mode for bowl flush.

The bowl flush water volume can be adjusted by the bowl flush flow control knob located inside the cuspidor body.

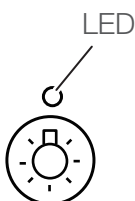

Handpiece light switch (on/off) E

Pick up the fiber optic handpiece from the holder, momentarily press the light pack switch (R), the indicator illuminates in green and the fiber optic power turns on.

To switch off the light pack simply press the light pack switch again.

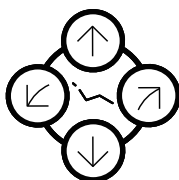

Chair manual control switches A E

Seat Lifting-----Press the () switch until the seat is lifted up to the desired position.

Seat Lowering -----Press the () switch until the seat is lowered to the desired position.

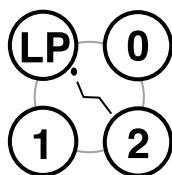

Backrest Reclining ----Press the () switch until the backrest is reclined to the desired position.

Backrest Raising -----Press the () switch until the backrest is raised up to the desired position.



Chair manual mode switches A E

Preset operation

Momentarily press the preset-1 switch (), the chair moves to the preset 1 position and stops automatically. Preset 2 position operated by the preset switch ().

Note : For preset position adjustment refer to chair Manual.

Automatic return operation

Momentarily press the auto return switch (), the chair returns to the initial position (the seat is the lowest position and the backrest is the upright position) and stops automatically.

Last position memory operation

Momentarily press the last position memory switch (), at the treatment position, the backrest raises up to the rinsing position (upright position) and stops automatically.

Momentarily press the last position memory switch () again, the backrest returns to the previous treatment position and stops automatically.

Emergency stop (Safety stop)

During automatic movements (preset, auto return and last position memory), by momentarily pressing any chair control switch this will cancel the automatic movement immediately.

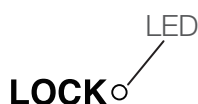

Chair lock indicator A E

The safety lock indicator illuminates amber when the safety lock device is working.

Note: Please refer to 5-4. Lock function

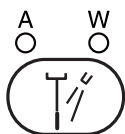

Coolant water ON/OFF switch E

When a handpiece is picked up and this switch is pressed, both LED A (air) and LED W (water) lights up, the coolant water and air comes out from the handpiece. In case of air motor or air turbine, switching between spray (both of LED A and LED W are lit) and OFF occurs when this switch is pressed. In case of electric scaler, switching between water only (LED W is lit) and OFF occurs when this switch is pressed, regardless of the mode.

In case of micromotor, either the 2-mode or the 4-mode can be selected by mode select setup. When this switch is pressed in the 2-mode setup, switching between spray and OFF occurs. In case of 4-mode setup, switching occurs in the sequence indicated below each time when this switch is pressed: Spray to Water only to Air only to OFF.

As for the mode setting, please refer to 5-1-3. Function switch setup procedure.





Electric motor speed set switch E

Two different modes, limit mode and preset mode, are available as micromotor rotation speed modes. Pressing this switch each time changes the speed mode: Limit speed -> SET1 -> SET2 -> SET3 -> Limit speed.

The indicator indicates the selected mode.

1) Switching to limit rotation speed (limit mode)

Pick up the micromotor from the holder, and press this switch (), to select limit mode. For selecting the upper limit in the limit mode, press either plus (), switch or minus (), switch. The upper limit of the micromotor rotation speed changes in three steps (or 5 steps).

- Upper limit of rotation speed in case of 3 steps:

10000/20000/40000 min⁻¹(rpm)



- Upper limit of rotation speed in case of 5 steps:

5000/10000/20000/30000/40000 min⁻¹(rpm)

As for the 5 step setting, please refer to 5-1-3. Function switch setup procedure.

2) Switching to preset rotation speed (preset mode)

Pick up the micromotor out of the holder, press this switch (), and then select preset mode (SET1 to 3).

The rotation speed in this mode can be changed by pressing plus () switch or minus () switch.

Press store switch () for storing the changed rotation speed.

When the foot controller is depressed upon selection of preset mode (SET1 to 3), the micromotor runs at the fixed rotation speed indicated on the indicator.

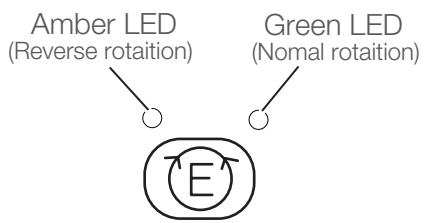

Micromotor rotation switch for normal/reverse E

After picking up the electric motor from the holder, the electric motor rotation direction can be changed by momentarily pressing this switch (E) the rotation direction will be indicated by the amber and green LEDs.

Indicator in green :Normal rotation

Indicator in amber :Reverse rotation

Note: Do not change the electric motor direction while the motor is running.

When the electric motor with setting reverse rotation is returned the holder and picked up again, a buzzer sounds.



Dental light ON/OFF switch E

Switch for on/off the dental light.



Function switch E

Use this switch for setting various working conditions.

TIMER SET
=START

5-1-3 Function switch setup procedure

1. Timer

Timer can be set maximum 90 mins. 50 secs. in 10 secs. segment.



Function Switch



Decrease Switch



Increase Switch



Start switch

1) To set a timer

Momentarily press the function switch, and set the time by pressing decrease switch and increase switch.

....Minimum setting time by switch is 10 seconds.

....Minimum setting time by switch is 1 minute.

The setting time is indicated on the function indicator.

Momentarily press the start switch to start timer. The end of setting time is informed by electronic sounds.

Example: Setting time 3 minutes 30 seconds is indicated as 03:30 in the function indicator.

2) Preset time setting



Function Switch



Decrease Switch



Increase Switch



Store switch



Four preset time can be set. (0) (1) (2) (LP)

Momentarily press function switch, and set the time by pressing decrease switch and increase switch.

Press the store switch, then press the (0)(1)(2) or (LP) switch to store in memory.

3) Preset time operation



Function Switch



Start switch



Press the function switch, then press the (0)(1)(2) or (LP) switch to choose desired preset number.

Press start switch to start timer.

4) Cancel the timer during time countdown



Function Switch



Start switch

Momentarily press function switch, then press start switch to cancel timer.

Dr.NUMBER =0 ↓

2. Group selection mode

The group selection mode is a convenient function for the dental clinic where a multiple (up to four groups) of dentists work with one unit.

The following functions can be set for each group.

Preset position for chair.

Preset rotation speed for micro motor.

To set the group.

1) Momentarily press the function switch twice on main control panel, and the function indicator will indicate group number.

2) Momentarily press the 0,1, 2 or LP switch on main control panel to set one of 4 group.

0; Group 1 / 1; Group2 / 2; Group3 / LP ;Group4



Function Switch

FLUSH OUT F=↓
(-)=HP (+)=HP+碗

3. Flush out system

The CELEB is equipped with two types of flush out system. Short time flush out is for cleaning handpiece water lines.

Long time flush out is for handpiece water lines, bowl flush water line and cupfiller water line.

Without cuspidor bowl type: long-term flushing cannot be used.

To discharge the water from the handpiece, use the basin or bucket.



Function Switch Decrease Switch Increase Switch

1) Short time flush out

Momentarily press the function switch three times and momentarily press the decrease switch. Pick up the handpieces from the holder and set them in the cuspidor bowl. By momentarily pressing the foot controller this starts short time flush out.

Water comes out from the handpiece and stops automatically after 40 seconds. During flush out, by momentarily pressing any one of unit control switch or foot controller will cancel flush out immediately.

2) Long time flush out

Momentarily press the function switch three times and momentarily press the increase switch. Pick up the handpieces from the holder and set them in the cuspidor bowl.

By momentarily pressing the foot controller this starts long time flush out for 5 minutes. Then, cupfiller and bowl flush out starts and stops automatically in another 5 minutes. During flush out, momentarily pressing the any one of unit control switch or foot controller will cancel flush out immediately.

* Operating instructions for flush out system **A**

Pick up the handpiece(s) from handpiece holder and set them in the cuspidor bowl. Water flows from handpiece(s) when turn on the flush out switch. To stop flush out operation, turn off the flush out switch during flush out.

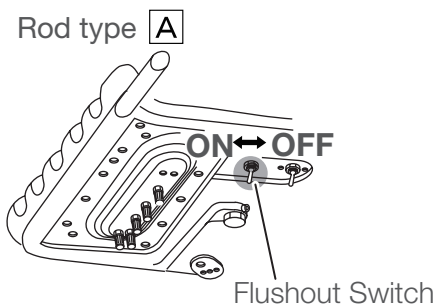
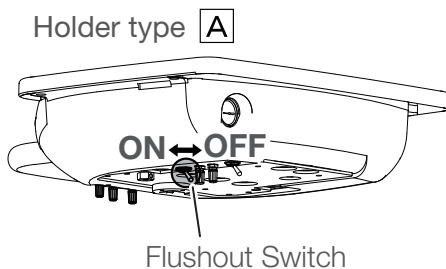

Beep=ON F=↓
(-)=OFF (+)=ON

4. Control panel switching sound on/off

Pressing a switch on the control panel makes an electronic sound. This sound can be eliminated as follows;

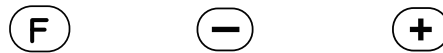

Function Switch Decrease Switch Increase Switch

Momentarily press the function switch four times and momentarily press the decrease switch.

To return to original setting.

Momentarily press the function switch four times and momentarily press the increase switch.

LP,MODE=HOLD F=↓
(-)=FOOT (+)=HOLD

5. Fiber optic handpiece lighting mode (Optional)

In case that fiber optic handpiece is installed, the fiber optic turns on when the handpiece is taken out of the holder, and turns off when the handpiece is returned to the holder.

This could be changed to fiber optic turns on when the handpiece is taken out of the holder and drive air pedal of foot control is activated.



Function Switch Decrease Switch Increase Switch

Momentarily press the function switch five times and press the decrease switch.

To return to original setting.

Momentarily press the function switch five times and press the increase switch.

ALARM TYPE = 0 F=↓
PUSH 0 1 2 LP(3)

6. Electronic sound for time

Electronic sound for timer can be changed.



Function Switch

Momentarily press the function switch six times.

Momentarily press one of chair auto mode switch (0,1,2,LP) then the new electronic sound is to be memorized.

M.LMT=3 STEP F=↓
(-)=3 (+)=5 STEP

7. Micromotor maximum speed setting (Optional)

The maximum rotation speed of the micromotor can be selected in 3 steps (10000,20000,40000min-1(rpm)).

This function can be changed to 5 steps (5000,10000,20000,30000,40000min-1(rpm)) as follows:



Function Switch Decrease Switch Increase Switch

Momentarily press the function switch seven times and press the increase switch.

To return to original setting.

Momentarily press the function switch seven times and press the decrease switch.

SPRAY=4MODE F=↓
 (-)=2 (+)=4 MODE

8. Coolant water ON/OFF switch

In case of micromotor, either the 2-mode or the 4-mode can be selected by mode select setup.

When this switch is pressed in the 2-mode setup, switching between spray and OFF occurs.

In case of 4-mode setup, switching occurs in the sequence indicated below each time when this switch is pressed: Spray to Water only to Air only to OFF.



Function Switch



Decrease Switch



Increase Switch



Coolant water
ON/OFF switch

To set 2 mode

Momentarily press the function switch eight times and press the decrease switch.

To set 4 mode

Momentarily press the function switch eight times and press the increase switch.

LINK F=E
 (-)=IND (+)=LINK

9. Cupfiller and bowl flush

Cupfiller and bowl flush are set to operate together (when the cupfiller switch is activated, bowl flush also starts).

To make these operate independently.



Function Switch



Decrease Switch



Increase Switch

Momentarily press the function switch nine times and press the decrease switch.

To return to original setting.

Momentarily press the function switch nine times and press the increase switch.

Holder type

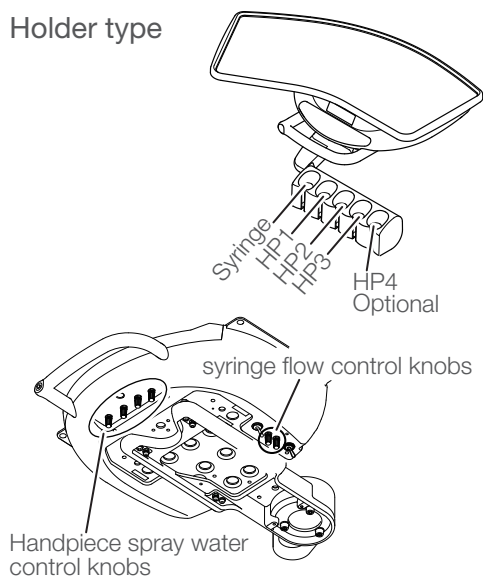

Rod type

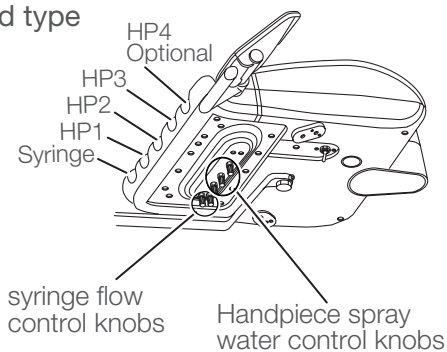

Holder type

Rear side of the doctor table

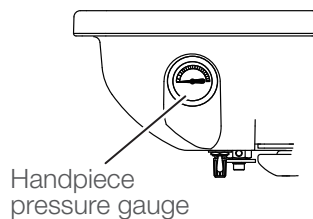

Rod type

Under of the doctor table

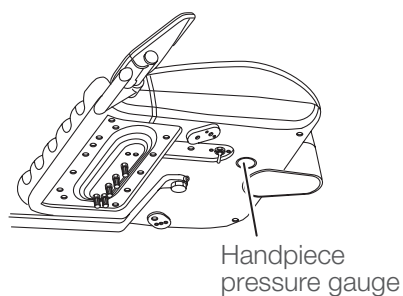

5-1-4 Control knobs

Handpiece spray water control knobs

The handpiece spray water control knobs are located under the doctor table.

Each handpiece spray water control knob is marked 1-4 from the left side HP1,HP2,HP3,...

The handpiece spray water volume can be controlled independently.

*The HP4 is optional.

Syringe flow control knobs

Doctor's syringe flow control knobs are located under the doctor table.

The flow control knobs adjust the doctor's syringe air and water flow volume.

The yellow capped knob is the air flow control knob, the blue capped knob is the water flow control knob.

Note : Turning the control knob counterclockwise will increase the flow volume and turning clockwise will decrease.

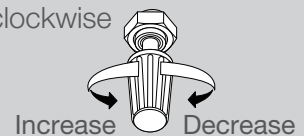

5-1-5 Handpiece pressure gauge

While a handpiece is working, the handpiece drive air pressure is indicated on the handpiece pressure gauge.

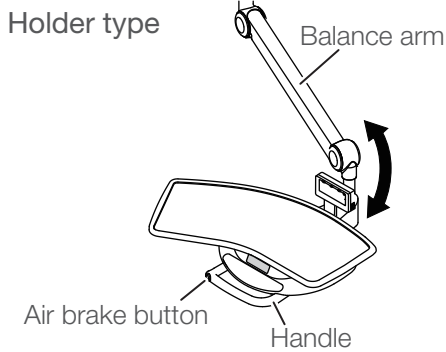

5-1-6 Balance arm air brake

Balance arm air brake button is located on the handle. When the master switch is ON, the balance arm is locked. Grasp the handle and press the air brake button to adjust the table height. Release the air brake button at the desired table position, the balance arm is locked.

WARNING

Do not load over 3 kg on the table. [Holder type]

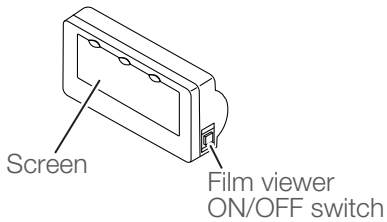
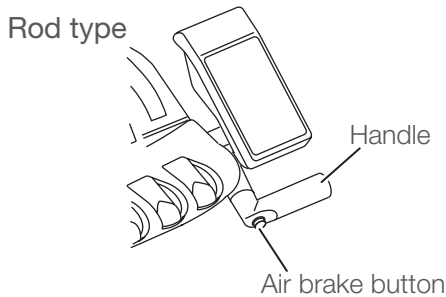

5-1-7 Film viewer

Dental viewer

Press the switch to turn the screen on. Press it again to turn the screen off.

When it is not being used, turn it off. The dental viewer is designed to supplement X-ray observation and is not for examination or diagnosis.

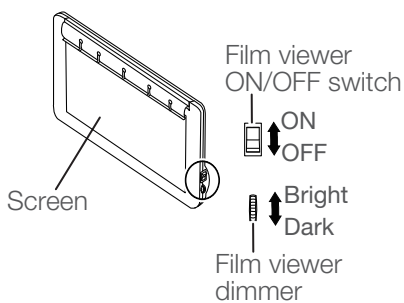

Panoramic viewer

Turn the switch upward to turn on the screen and downward to turn it off.

Turn the luminance controller upward to increase the luminance and downward to lower it.

When it is not being used, turn it off. The panoramic viewer is designed to supplement X-ray observation and is not for examination or diagnosis.

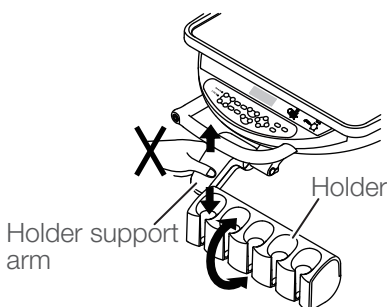

5-1-8 Holder support arm / Holder

CAUTION

Do not adjust the holder support arm and holder. Because the angle adjustment of the holder is fixed at the point of installation, the holder support arm will be damaged in case it is moved too hard.

5-1-9 Handpieces

The handpiece is actuated by picking it up from the handpiece holder and operating the foot controller. Operation of the each handpieces, please refer to the manufacturer's instruction manual attached to the individual equipment.

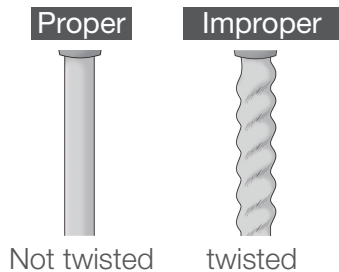

CAUTION

Repeated actions of picking up and returning the handpiece may cause its hose twisted. Check the hose periodically to see if it is not twisted. If twisted, unwind it before use. Continual use of the handpiece with its hose twisted will cause the kinks in the hose or breaking of the wire, making the handpiece unusable.

5-1-10 Table height adjustment (Cart type)

Loosen the lock knob to raise or lower the table section. Fix the table in place by firmly tightening the lock knob after adjustment.

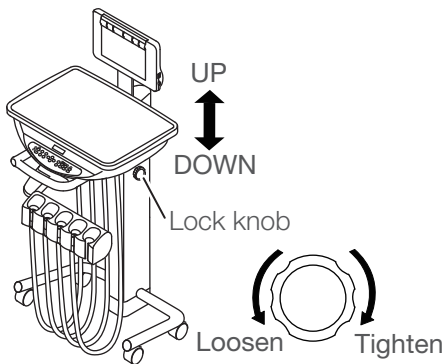

CAUTION

- Do not place objects on the table during table height adjustment.
- Be sure to hold the table section before loosen the lock knob.
- Be sure to tighten the lock knob after adjustment.

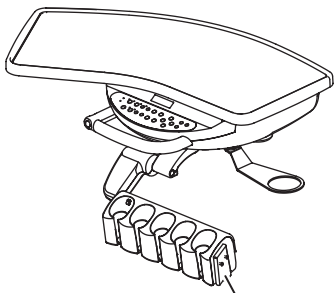

Intraoral camera holder bracket

5-1-11 Intraoral camera holder bracket

Intraoral camera holder can be mounted on this bracket.

[Note] Mountable intraoral camera holders :
Holder for SOPRO ACTEON SOPRO 617

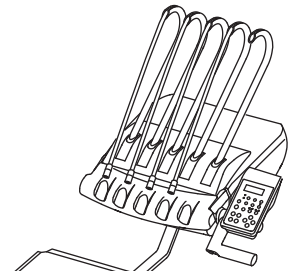

Sub tray holder

5-1-12 Sub tray holder

WARNING

A load exceeding the weight limit (1.5 kg) must not be applied to the sub-tray of the doctor table (Rod). This may cause damage or injury.

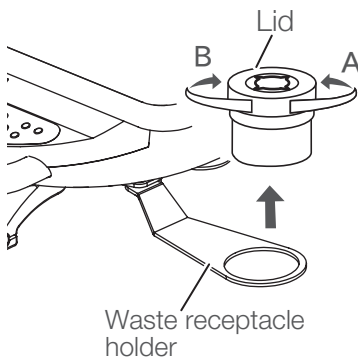

5-1-13 Waste receptacle

Dispose of waste material and clean it when waste accumulates. The stainless waste receptacle may be detached when it is turned in direction A.

The lid has sharp portions that can easily catch cotton, etc. Be very careful when cleaning it.

5-1-14 Cotton Containers

Use it for keeps clean cotton.

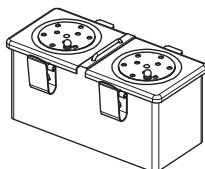

5-2 Cuspidor unit section

5-2-1 Cuspidor unit control panel

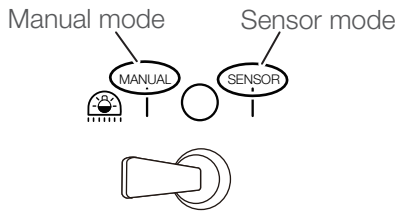
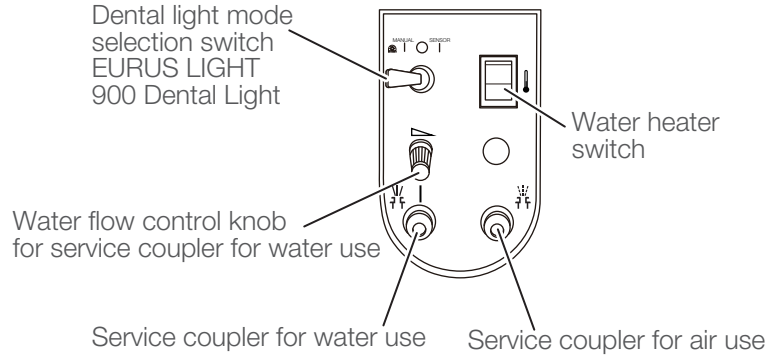
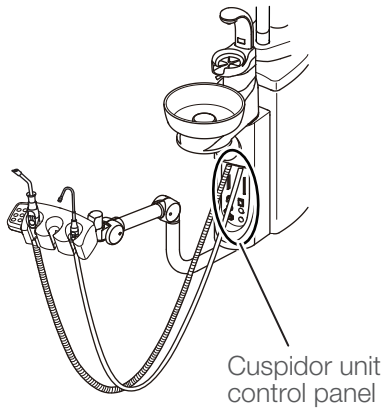

Dental light mode selection switch

EURUS LIGHT/900 Dental Light

Dental light can be operated (ON/OFF) either by the touchless switch located on the light head, or by the manual switch on the cuspidor unit control panel.

To operate by the touchless switch: Set the switch lever to SENSOR side.

To operate manually: Set the switch lever to Manual Side.
Set the switch lever to centre for OFF.

Water heater switch

Turn on the water heater switch and the cupfiller water will warm up.

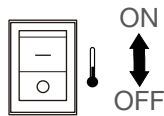

Service coupler for water use

Supplies water to an external device.

Quick connector for water service outlet

Model number : MCL-04NH-1B



Water flow control knob for service coupler for water use

Turning the knob counterclockwise will increase the flow volume and turning clockwise will decrease.



Service coupler for air use

Supplies air to an external device.

Quick connector for air service outlet

Model number



5-2-2 Assistant side control panel

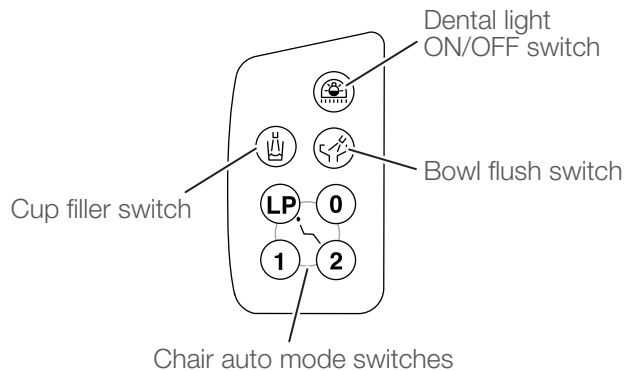
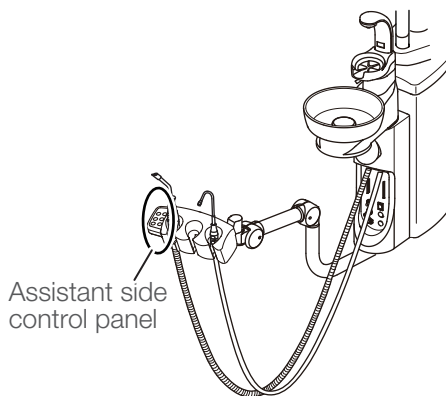

Cupfiller switch

Momentarily press the cupfiller switch (☺), water will come out from the cupfiller nozzle for 3 seconds and stops automatically. Also the bowl flush starts and will run for 6 seconds and stops automatically.

While the cupfiller is working, by momentarily pressing the cupfiller switch (☺) the cupfilling will cancel.

Also, when the cupfiller starts, the cuspidor water flushes 6 seconds and stops automatically. (Synchronized Bowl Flush)

Note :The cupfiller water volume can be adjusted by the cupfiller flow control knob located inside the cuspidor body.



Bowl flush switch

Momentarily press the bowl flush switch (☺), water flushes for 6 seconds and stops automatically. (Timer mode) Press the bowl flush switch for 2 seconds, water flushes continuously. (Continuous mode)

(Continuous mode)

While the bowl flush is working by momentarily pressing the bowl flush switch (☺), the bowl flush will stop.

Note : CELEB can be set to timer mode (standard setting) and continuous mode for bowl flush.

The bowl flush water volume can be adjusted by the bowl flush flow control knob located inside the cuspidor body.



Dental light ON/OFF switch

Switch for on/off the dental light.

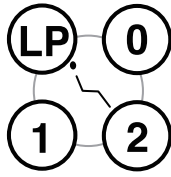

Chair auto mode switches

Preset operation

Momentarily press the preset-1 switch (①), the chair moves to the preset 1 position and stops automatically.

Preset 2 position operated by the preset switch (②).

Note : For preset position adjustment refer to chair Manual.

Automatic return operation

Momentarily press the auto return switch (①),

the chair returns to the initial position (the seat is the lowest position and the backrest is the upright position) and stops automatically.

Last position memory operation

Momentarily press the last position memory switch (LP), at the treatment position, the backrest raises up to the rinsing position (upright position) and stops automatically.

Momentarily press the last position memory switch (LP) again, the backrest returns to the previous treatment position and stops automatically.

Emergency stop (Safety stop)

During automatic movements (preset, auto return and last position memory), by momentarily pressing any chair control switch this will cancel the automatic movement immediately.

5-2-3 Control knobs

Syringe flow control knobs

Assistant's syringe flow control knobs are located in the cuspidor unit body.

The yellow capped knob is to adjust the assistant's syringe air flow volume, and the blue capped knob is to adjust water flow volume.

Cupfiller flow control knob

Cupfiller flow volume can be controlled by the cupfiller flow control knob. (Pinch valve system)

Loosen the lock nut and adjust cupfiller water flow volume by turning the knob.

Tighten the lock nut after adjustment.

Bowl flush flow control knob

Bowl flush flow volume can be controlled by the bowl flush flow control knob.(Pinch valve system)

Loosen the lock nut and adjust bowl flush water flow volume by turning the knob.

Tighten the lock nut after adjustment.

Note: Turning a knob counterclockwise increase flow volume and turning clockwise will decrease.

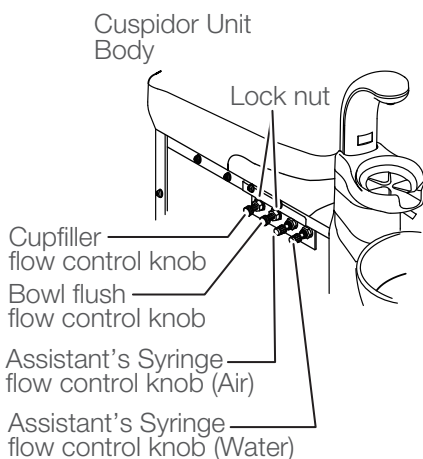

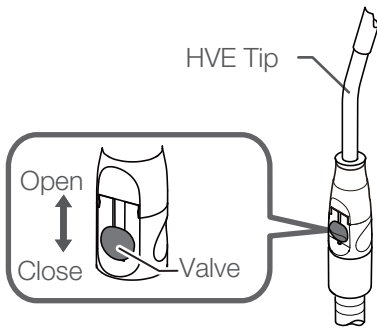

5-2-4 VH-18 HVE (High-volume evacuator)

Take the HVE out of the assistant holder, and suction will start. Since a delay circuit is provided, suction does not stop immediately when the HVE is returned to the assistant holder. In case of the central suction system, suction will continue for approx. 3 seconds. The suction volume may be controlled by opening or closing the valve.
Tip size : $\Phi 11/\Phi 16$

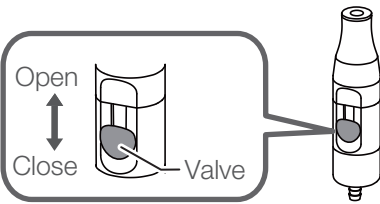

5-2-5 BT06 Saliva ejector

Take the saliva ejector out of the assistant holder, and suction will start. Since a delay circuit is provided, suction does not stop immediately when the saliva ejector is returned to the assistant holder. In case of the central suction system, It will continue for approx. 3 seconds. The suction volume may be controlled by opening or closing the valve.
* Use the disposable saliva ejector tip.

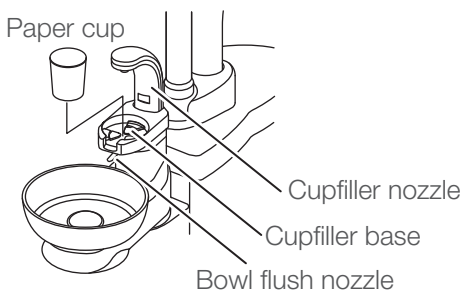

5-2-6 Sensor cupfiller

Place the cup (paper cup) on the cupfiller base, water comes out from the cupfiller nozzle, fills up the cup and stops automatically. When cupfiller starts, the bowl flush also starts, and will run for about 6 sec. and it stops automatically. While filling the cup, by momentarily pressing the cupfiller switch (☺) this will cancel the cup filler water flow. During bowl flush, momentarily press the bowl flush switch (☹) this will cancel the bowl flush water flow.

Use only suitable disposable paper cup (dental paper cup).
Use only an empty cup, using a cup with some water left, can cause an over flow.
The sensor cupfiller needs over 2 seconds interval between cup filling.

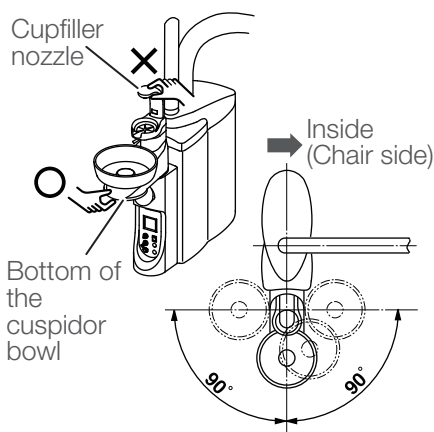

5-2-7 Cuspidor Bowl Rotation (Optional)

The cuspidor bowl can be rotated 90° each. (inside & outside)

⚠ CAUTION

Do not hold the cupfiller nozzle when rotating the cuspidor bowl; be sure to hold the bottom of the cuspidor bowl. Rotating via the cupfiller nozzle may result in damage to the cupfiller nozzle.

5 Operation

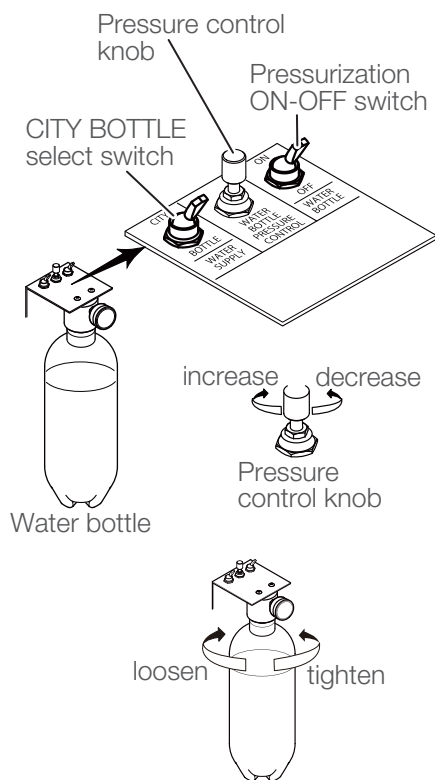

5-2-8 Clean water system

CITY BOTTLE select switch can be changed between municipal water and water bottle.

CITY..... Tap water

BOTTLE... Water bottle

When the pressurization ON-OFF switch is set to ON, the water bottle may be used.

The water bottle pressure control knob adjusts the pressure of water bottle.

The pressure increases when the knob is turned clockwise, and decreases when the knob is turned counterclockwise.

Replacing the water bottle

[How to remove the water bottle]

1) Flip the pressurization ON-OFF switch to the down (OFF).

2) Turn the water bottle and remove it.

Turning it counterclockwise will loosen the connection.

Turning it clockwise will tighten the connection.

[How to attach it]

Reattach it in the reverse order of remove.

⚠ CAUTION

- The water bottle is intended only for use with purified water, distilled water and pure water.
- Do not use mouthwash or electrolyzed water, as they may cause clogged tubing or affect internal valves and equipment.
- Adjust the air supply pressure for the water bottle to 200 kPa or less. An excessively high pressure may cause damage to the water bottle.

5-2-9 Height adjustable assistant arm

Press the lock release button and raise arm to adjust the assistant holder height.

Position at desired height and release the lock button after that.

Note: Support the arm with your hand until it is positioned at the desired height.

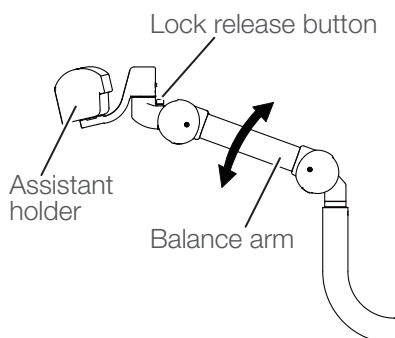



300 (Type 320S)

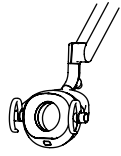

EURUS LIGHT

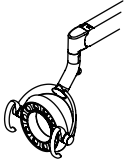

900 (Type D200)

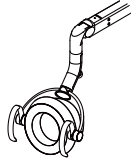

900 (Type 920)

5-2-10 Dental light

Before use, always read the Instructions for dental light to ensure correct usage.

5-2-11 Monitor Bracket

the PC monitor can be mounted on this bracket.

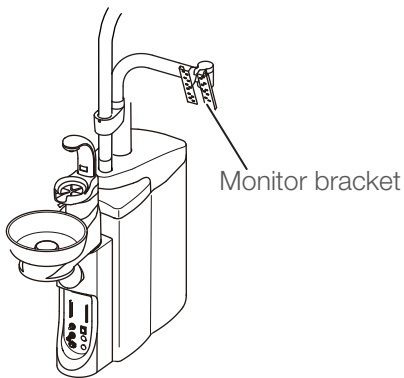

CAUTION

Do not apply an excessive load or shock to the monitor or monitor bracket. To avoid damage or injury, ensure that the monitor satisfies the following specifications:

Weight: 4 kg

5-3 3WAY Syringe

SYR-20

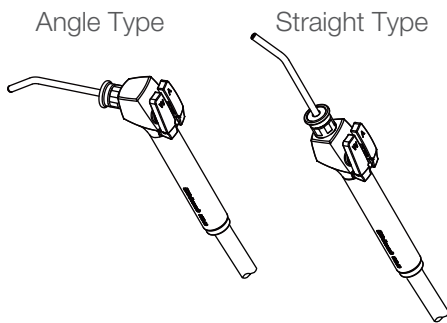

Spraying water / air

Press W lever to have water come out.

Press A lever to have air come out.

Press both levers simultaneously to have spray come out.

Water comes out from the center of the tip, and air comes out from the circumference of the tip.

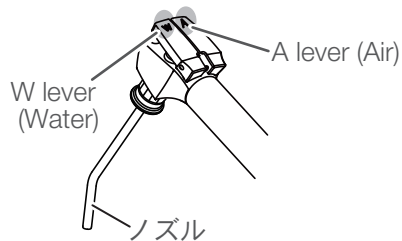

Rotation of the nozzle

Nozzle rotates through 360°.

77 type 3Way

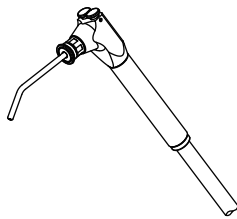

Spraying water / air

Press W marking button to have water come out.

Press A marking button to have air come out.

Press both buttons simultaneously to have spray come out.

Water comes out from the center of the tip, and air comes out from the circumference of the tip.

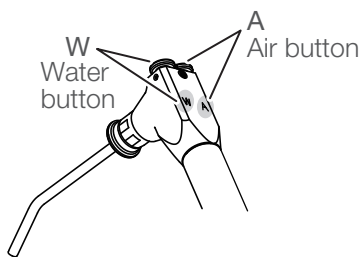

Rotation of the nozzle

Nozzle rotates through 360°.

Tip of the nozzle
(Common to all types)

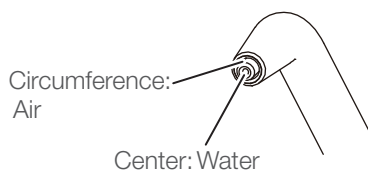

If the air is provided immediately after the usage of water or attaching the nozzle, a little water remaining in the nozzle may come out. When providing air, press the A lever for two or three times to confirm that water does not come out.

5 Operation

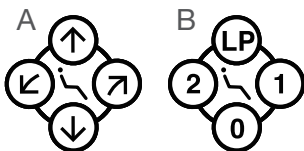
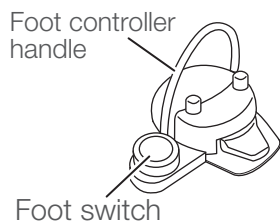
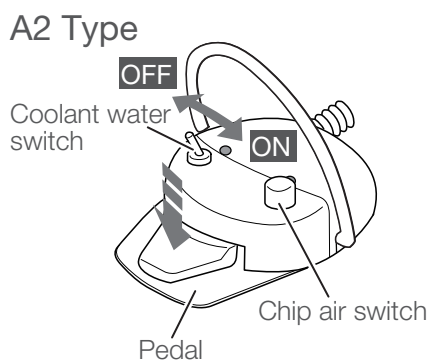
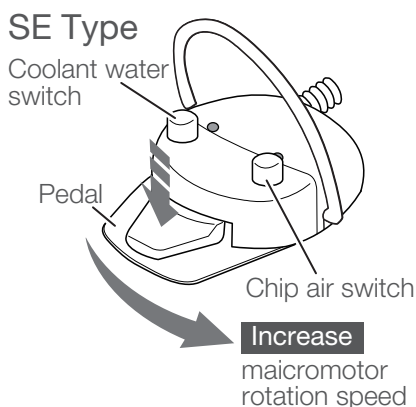
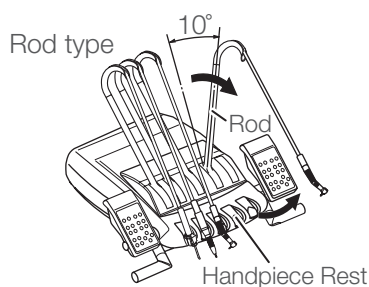

5-4 Foot controller

Pick up a handpiece from the handpiece holder or the handpiece rest (pull the rod about 10 degrees to forward).

SE Type **E**

Pedal

Pick up a handpiece from the handpiece holder and depress the drive air pedal, the handpiece starts running.

Coolant water switch

Momentarily depressing the coolant water switch is changed handpiece coolant water and air situation.

The situation is shown on the main control panel.

Refer: 5-1 Doctor unit section Main control panel Coolant water ON/OFF switch.

Chip air switch

By depressing the chip blower switch, the chip air will come out from handpiece without the bur rotating.

Micromotor rotation control

Pick up the micromotor from the handpiece holder and while pressing down slide drive air pedal horizontally to right, and the micromotor will start running.

The rotation speed increases by sliding the pedal further to the right. The speed control by the foot control is within the limits of the micromotor speed setting.

A2 Type **A**

Pedal

Pick up a handpiece from the handpiece holder and depress the drive air pedal, the handpiece starts running.

Coolant water switch

Coolant water switch allows handpiece coolant water to be turned on or off.

Chip air switch

By depressing the chip blower switch, the chip air will come out from handpiece without the bur rotating.

Foot controller handle

The foot controller can be moved by hanging it over the foot.

Foot switch

A. Chair manual control switches

B. Chair auto mode switches

5-5 Lock function

Chair lock indicator

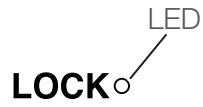

In the following cases the safety lock device to lock the chair movement is activated.

1. When the pedal of the foot controller is depressed.
2. Press any chair operation switches for stopping the automatic movement.
3. During setting with the function switch on the doctor control panel.
4. When the cuspidor bowl is rotated toward the patient side. (Pedestal type)

6 Maintenance and Cleaning

6-1 Exterior

Cleaning and disinfecting the surfaces

To clean and disinfect the exterior of the product, wipe the surface with a soft cloth or paper towel moistened with FD366 manufactured by Dürr / PlastiSept eco Wipes FP manufactured by ALPRO, and then wipe it with a dry cloth.

CAUTION

- If the exterior is excessively dirty, moisten a soft cloth with water containing approx. 10% of neutral detergent, and wipe the exterior with the cloth. Then, wipe it with a cloth moistened with water and dry it completely with a dry cloth.
- Never use any of the products listed below:
Volatile chemicals such as paint thinner, butanol, isopropyl alcohol, nail-varnish remover, gasoline, or kerosene; acid, alkaline or chlorine detergents; highly corrosive disinfectants (povidone-iodine such as Isodine, sodium hypochlorite, etc.); abrasive polishing wax or abra-sive sponge.
- If water or detergent is left on the surface, wipe it off immediately. Moisture or detergent may cause rust or failure of electrical parts.

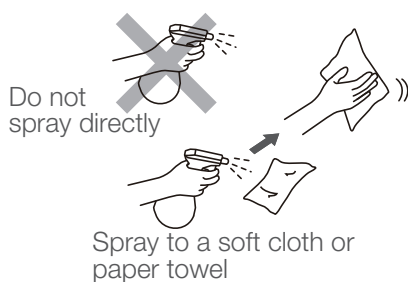
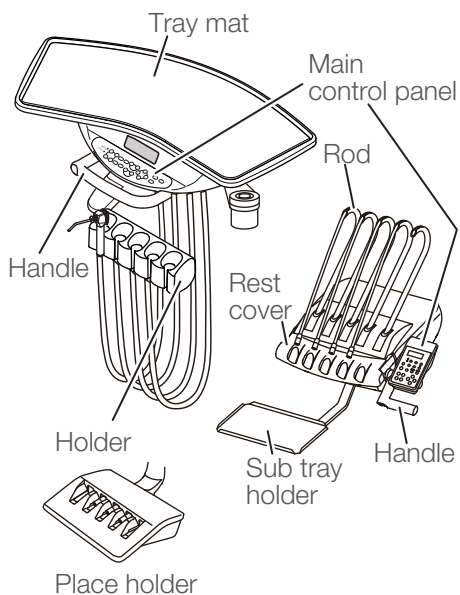

6-2 Doctor unit

Tray mat, Main control panel, Handle, Holder, Place holder, Rod, Rest cover, Sub tray holder

Cleaning and disinfecting the surfaces

Wipe the surface with a soft cloth or paper towel moistened with FD366 manufactured by Dürr / PlastiSept eco Wipes FP manufactured by ALPRO, and then wipe it with a dry cloth. If the exterior is excessively dirty, moisten a soft cloth with water containing approx. 10% neutral detergent, and wipe the exterior with the cloth. Then, wipe it with a cloth moistened with water and then dry it completely with a dry cloth.

Do not spray detergent directly onto the exterior. Clean the surface with a soft cloth or paper towel moistened with detergent, and wipe it with a dry cloth. If liquid enters the product, it may cause a malfunction or failure.

When the surface of the main control panel is cleaned with disinfectant, etc., wipe off disinfectant completely. If it penetrates into the back of the sheet, the membrane switches may malfunction.

6 Maintenance and Cleaning

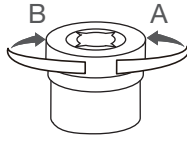

Waste container

When the waste container becomes full, the stainless waste receptacle may be detached when it is turned in direction A. It is fastened when turned in direction B.

The lid has sharp portions that can easily catch cotton, etc. Be very careful when cleaning it.

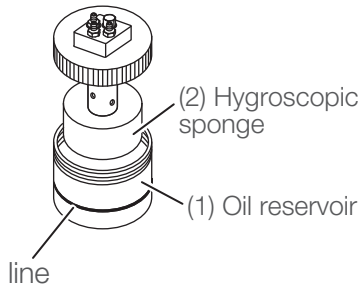

Oil mist separator

This unit collects oil from the exhaust air from the handpiece. When oil reaches to the line on the oil reservoir (1), make sure you discard the oil.

Turn the oil reservoir counterclockwise to remove.

If the hygroscopic sponge (2) (consumable) is excessively dirty or has excessive oil on it, replace it.

Contact your local authorized Belmont dealer for a replacement for the hygroscopic sponge. (Replacement will be charged for.)

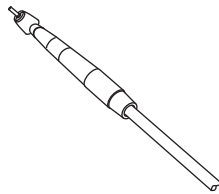

Handpieces/Handpiece hose

Cleaning of handpieces

Refer to the Instructions for Use for the respective handpieces.

6 Maintenance and Cleaning

6-3 Cuspidor unit

Drain Cap, Basket Strainer, Cupfiller base, Cuspidor Bowl

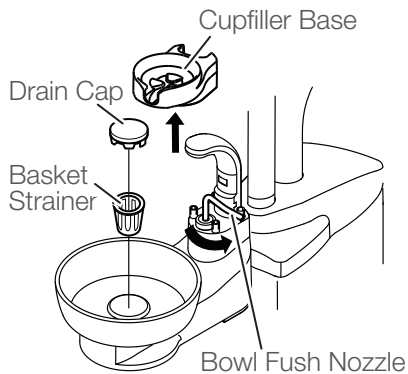

A. Detach the drain cap, and clean the basket strainer.

Remove the cupfiller base and clean it.

Turn the bowl flush nozzle counterclockwise, avoiding the clash with the cuspidor bowl.

B. Turn the cuspidor bowl to left and right and remove it upward.

CAUTION

- Turn off the main switch before removing the cuspidor bowl.
- Cuspidor bowl is made of glass or ceramic and may be broken when given the impact. When and after removing or attaching the cuspidor bowl, be aware of the handling, avoiding the impact, hitting and falling.

When carrying the cuspidor bowl, hold it firmly with both hands while placing one hand at the bottom of the cuspidor bowl.

- Do not clean the cuspidor bowl using hot water because it may be broken.

- Put on the durable gloves when cleaning.

C. When it is hard to attach the cuspidor bowl after cleaning, wet the inserting surface for an easy attachment.

After the attachment, make sure the cuspidor bowl is attached firmly.

D. After attaching the cuspidor bowl, return the bowl flush nozzle to the original position and attach the cupfiller base.

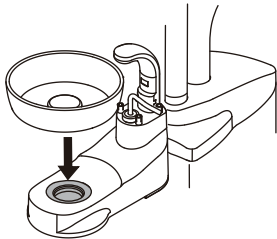
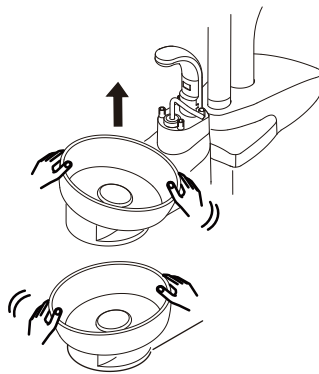

Solid collector

Detach and wash the filter in the solid collector of the cuspidor unit at the end of each work day.

If sucked substances are collected, the suction force of the vacuum is reduced.

[Detach/Attach the filter]

1. Pull out and detach the lid from solid collector.
2. Separate the lid and the filter by pulling the lid as shown in the figure.
3. Clean the filter and lid with running water.
4. Attach the lid to the filter by meeting claws of the lid with fixing hole of the filter.
5. Attach the filter in the reverse order.

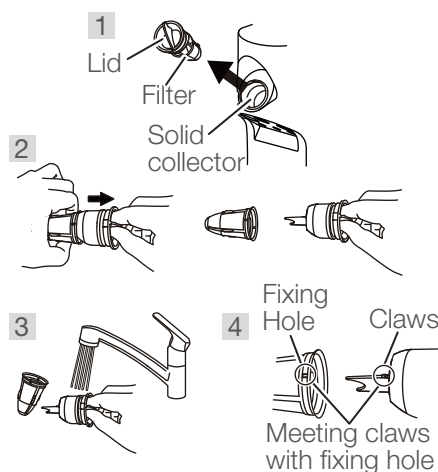

correct



Obtuse shape of knob is on upper side

Incorrect



Acute shape of knob is on upper side

CAUTION

Be sure to firmly inset the solid collector in the correct direction. If not, vacuum and saliva ejector may not work properly.

6-4 Suction line

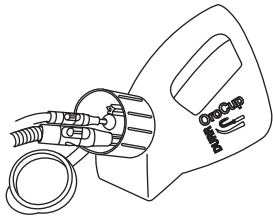

Handpieces for HVE and saliva ejector suction the secretions, saliva, or blood that contains bacteria. Therefore, always wash and sterilize them using MD555/Orotol plus manufactured by Dürr after the procedure.

Use Orotol Plus for daily care. In addition, we recommend using MD555 for weekly cleaning.

Do not use any detergent except our designated one. Otherwise, strong acidic detergents or alkaline drain preparations may cause clog, damage, or metal corrosion.

6-5 High-volume evacuator hose/Saliva ejector hose

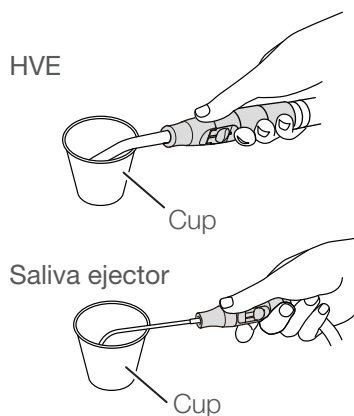

Suction a cup of water (approx. 100 ml) or more into the HVE and saliva ejector after use by a patient. This is to clean and dilute the medicine used and to prevent the handpieces deteriorating.

Some medicines used for the procedure may cause deterioration of the handpiece. It may dissolve, deform, or damage part of the handpiece, possibly resulting in leaks from the handpiece or suction failure. This will ultimately makes the handpiece unusable. Please wash them properly to ensure long-term use.

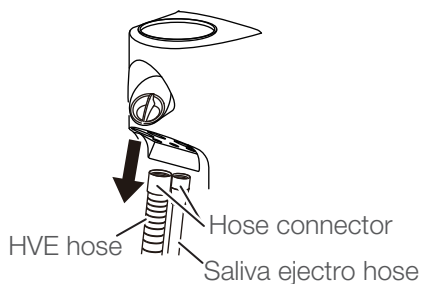

HVE hose and saliva ejector hose are detachable from the cuspidor unit

- The HVE hose and saliva ejector hose can be disconnected by pulling downward direction, as arrows is shown on the figure. Clean hoses in running water.
- Replace with a new HVE hose and saliva ejector hose if damage occurs or dirt on the hose becomes conspicuous.

Always turn off the main switch before pulling the hose off to wash it.

6-6 Water line

For water line care, use Alpron/Bilpron manufacture by ALPRON. Use Alpron for daily care. In addition, we recommend using Bilpron for weekly cleaning.

6 Maintenance and Cleaning

6-7 HVE (High-volume evacuator) and saliva ejector

(1) Disassembly

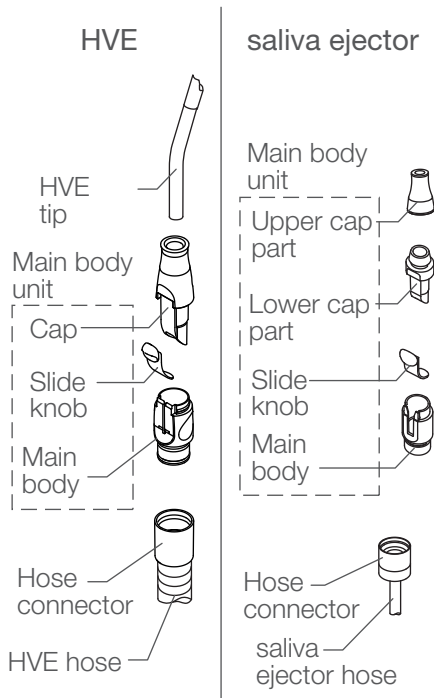

(2) Washing the surface

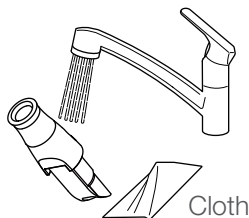

(3) Washing the interior and sliding part

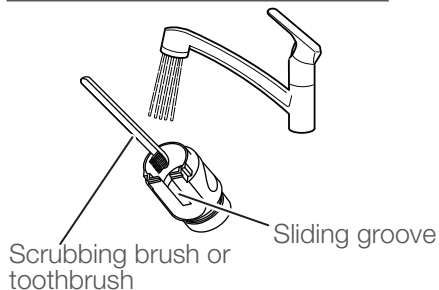

(4) Washing parts inaccessible with a brush

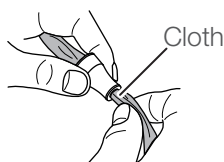

Wash and sterilize the handpieces between patients.

To properly sterilize the HVE and saliva ejector, it is necessary to wash them to remove dirt and immerse them in detergent.

Then, rinse them to remove any remaining detergent.

Follow the procedure below to wash and sterilize the handpieces.

(1) Disassembly

To prepare for washing, disassemble the handpieces as shown in the figure.

Hold the hose connector, and pull the HVE hose and saliva ejector hose to detach them from the main body.

(2) Washing the surface

Rinse the surface with clean water (tap water) warmed to a temperature of $40 \pm 5^\circ\text{C}$, and rub it with a cloth to remove dirt.

When all dirt is removed, wipe it dry.

(3) Washing the interior and sliding groove

Rinse the interior and sliding groove of the main body with clean water (tap water) warmed to a temperature of $40 \pm 5^\circ\text{C}$, and scrub them with a scrubbing brush or toothbrush.

When all dirt is removed, wipe them dry.

(4) Washing parts inaccessible with a brush

If some parts are inaccessible with a brush, rub them with a cloth.

Rinse them well with clean water (tap water) warmed to a temperature of $40 \pm 5^\circ\text{C}$ (for at least 1 minute).

Immerse the parts in ID212 manufactured by Dürr or alkaline cleaner for 5 minutes.

Then, rinse them well with clean water (tap water) warmed to a temperature of $40 \pm 5^\circ\text{C}$ (for at least 1 minute).

Inspect the parts for any visible dirt. If any visible dirt remains, repeat the above washing process.

Wash them immediately after use.

If the parts are in the condition described below after washing, do not autoclave them. Replace them.

A hole/holes are clogged, and dirt cannot be removed.

6 Maintenance and Cleaning

Caution when assembling HVE before sterilization

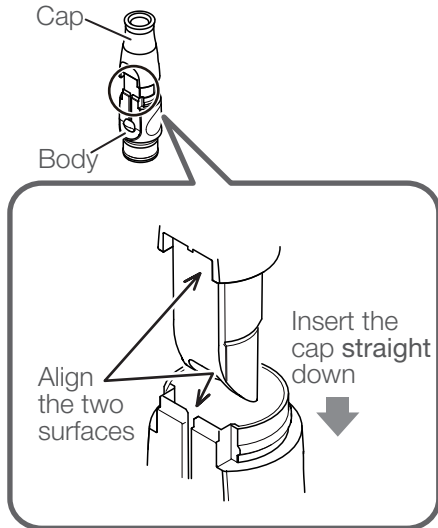

(5) Sterilization

The HVE and saliva ejector are autoclavable.

Reassemble the main body unit, and autoclave the HVE and saliva ejector.

When assembling the HVE, align the two surfaces; a flat surface of the cap and the surface of the sliding groove of the body. Then, slide the cap into the body straight.
* Do not insert it twisted.

1. Put the handpiece in a sterilization bag, and seal the opening.
2. Autoclave it at a temperature of 134°C for 3 minutes.

The handpieces can be autoclaved up to 250 times.

Storage method: After sterilization, store the handpiece in the sterilization bag in a dark, cool place.

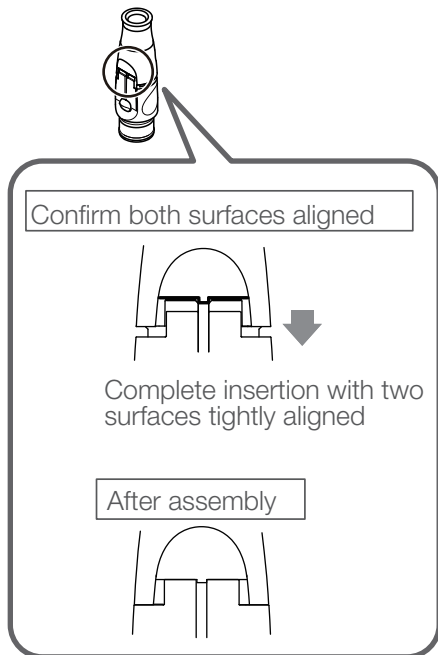

CAUTION

- Sterilization must be done every after use to patients.
- Autoclave sterilizer in compliance with Class B is recommended.
- Sterilization temperature is 135°C or less.
- Dry naturally if the temperature for drying process is to exceed 135°C.
- After autoclave sterilization, the cap, filter, body and valve are subject to discoloration, which does not have a negative effect on performance.
- The slide knob can be autoclave 100 times and is expendable supplies.
- If damage occurs to the sterilization bag, discard and sterilize again using a new sterilization bag.

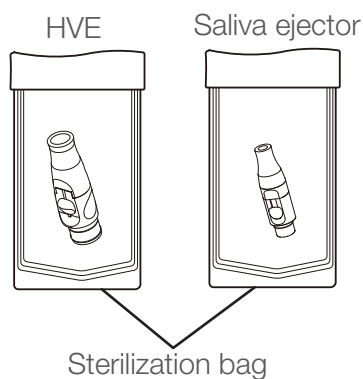

6-8 77 type 3WAY syringe

Wash and sterilize the handpieces between patients. To properly sterilize the 3way syringe, it is necessary to wash them to remove dirt and immerse them in detergent. Then, rinse them to remove any remaining detergent. Follow the procedure below to wash and sterilize the handpieces.

(1) Disassembly

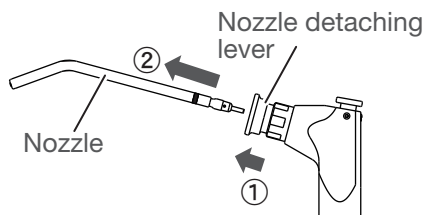

(1) Disassembly

To prepare for washing, disassemble the nozzle as shown in the figure. Pull the ① nozzle detaching lever to unlock the nozzle, ② then the nozzle is detachable.

(2) Washing the surface

[Hand washing]

A. Wipe off the surface contamination by a cloth while rinsing the surface by running clean warm water at 40 ± 5 degrees. Scrub the tip and joint part of nozzle by a cleaning brush or by a tooth brush with running clean warm water at 40 ± 5 degrees.

B. Check whether contamination is removed or not after cleaning. Continue the cleaning if contamination is remained.

C. Immersed with an alkaline disinfection or detergent for 5 minutes. (We recommend to use ID212 made by DURR)

D. Rinse thoroughly by distilled water at ordinary temperature or by clean water for more than 1 minute.

(2) Washing the surface

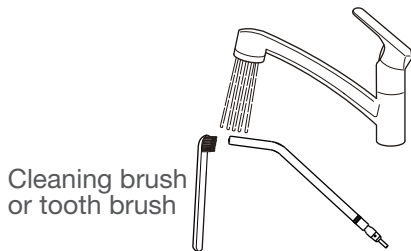

[Hand washing/Ultrasonic bath]

Clean nozzle under running water for 30 seconds with a soft brush and place in an ultrasonic bath with an enzymatic cleaner to remove superficial debris prior to sterilization.

If debris remains, the nozzle will not be properly sterilized.

CAUTION

Wash the nozzles immediately after use.

If chemicals or foreign substances adhere to the nozzle, failure may result or discoloration may occur.

Therefore, cleaning and washing must be done before autoclave sterilization.

If the dirt cannot be removed, replace the nozzles.

The handpieces can be autoclaved up to 250 times.

6 Maintenance and Cleaning

(3) Sterilization

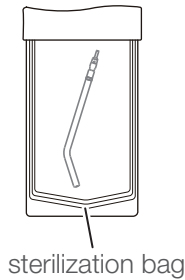

(3) Sterilization

Choose the appropriate method from the following sterilization cycles depending on the type of the autoclave sterilizer in your clinic:

[Dynamic-Air-Removal]

1. Put the nozzle in a sterilization bag, and seal the opening.
2. Autoclave it at a temperature of 134°C for 3 minutes with a 15-minute drying time.

[Gravity displacement]

1. Put the nozzle in a sterilization bag, and seal the opening.
2. Autoclave it at a temperature of 132°C for 15 minutes with a 30-minute drying time.

(4) Attaching the nozzle

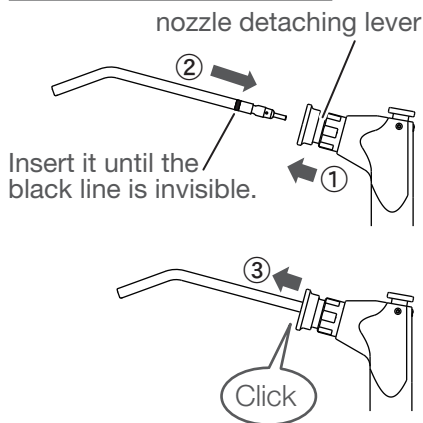

⚠ CAUTION

- Sterilization must be done every after use to patients.
- Do not sterilize the nozzle except for autoclave sterilization. Autoclave sterilizer in compliance with Class B is recommended.
- Sterilization temperature is 135°C or less.
- Dry naturally if the temperature for drying process is to exceed 135°C.
- If damage occurs to the sterilization bag, discard and sterilize again using a new sterilization bag.

Storage method: After sterilization, store the nozzle in the sterilization bag in a dark, cool place.

Example of attaching nozzle

Good example

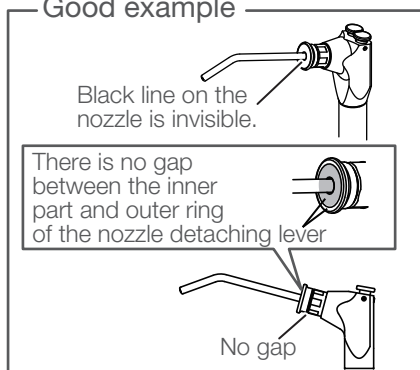

(4) Attaching the nozzle

- A. Pull the ① nozzle detaching lever and insert the nozzle until ② the black line is invisible shown in the left figure.
- B. Release the nozzle detaching lever and ③ pull the nozzle a little. It clicks and locked.
- C. After the nozzle is attached, confirm that the nozzle cannot be detached when pulling it. Follow the example of attaching nozzle shown in the figure, and check the nozzle is securely attached.

⚠ WARNING

If 77 type 3way syringe is used with its nozzle not securely attached, it may burst out when spraying water or air, and may harm users or other people.

Confirm that the nozzle is securely attached before its use.

Bad example

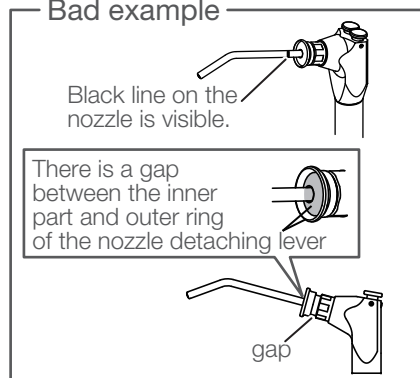

6-9 SYR-20 3WAY syringe

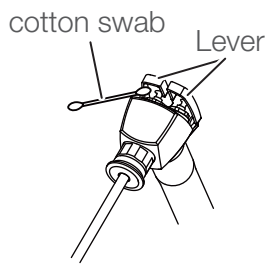

Cleaning the inside of the lever

If dust or dirt accumulates inside the lever, use a cotton swab to remove them.

Wash and sterilization

Wash and sterilize the handpieces between patients. To properly sterilize the 3way syringe, it is necessary to wash them to remove dirt and immerse them in detergent. Then, rinse them to remove any remaining detergent. Follow the procedure below to wash and sterilize the handpieces.

(1) Disassembly

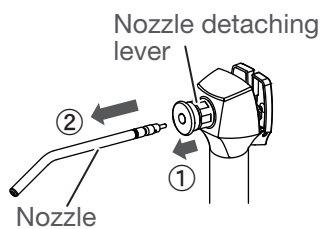

(1) Disassembly

To prepare for washing, disassemble the nozzle as shown in the figure. Pull the ① nozzle detaching lever to unlock the nozzle, ② then the nozzle is detachable.

(2) Washing the surface

[Hand washing]

A. Wipe off the surface contamination by a cloth while rinsing the surface by running clean warm water at 40 ± 5 degrees. Scrub the tip and joint part of nozzle by a cleaning brush or by a tooth brush with running clean warm water at 40 ± 5 degrees.

B. Check whether contamination is removed or not after cleaning. Continue the cleaning if contamination is remained.

C. Immersed with an alkaline disinfection or detergent for 5 minutes. (We recommend to use ID212 made by DURR)

D. Rinse thoroughly by distilled water at ordinary temperature or by clean water for more than 1 minute.

(2) Washing the surface

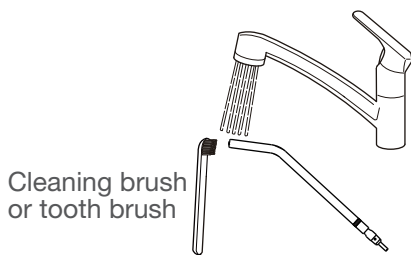

[Hand washing/Ultrasonic bath]

Clean nozzle under running water for 30 seconds with a soft brush and place in an ultrasonic bath with an enzymatic cleaner to remove superficial debris prior to sterilization.

If debris remains, the nozzle will not be properly sterilized.

⚠ CAUTION

Wash the nozzles immediately after use.

If chemicals or foreign substances adhere to the nozzle, failure may result or discoloration may occur.

Therefore, cleaning and washing must be done before autoclave sterilization.

If the dirt cannot be removed, replace the nozzles.

The handpieces can be autoclaved up to 250 times.

6 Maintenance and Cleaning

(3) Sterilization

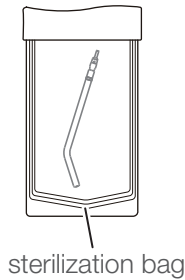

(3) Sterilization

Choose the appropriate method from the following sterilization cycles depending on the type of the autoclave sterilizer in your clinic:

[Dynamic-Air-Removal]

1. Put the nozzle in a sterilization bag, and seal the opening.
2. Autoclave it at a temperature of 134°C for 3 minutes with a 15-minute drying time.

[Gravity displacement]

1. Put the nozzle in a sterilization bag, and seal the opening.
2. Autoclave it at a temperature of 132°C for 15 minutes with a 30-minute drying time.

(4) Attaching the nozzle

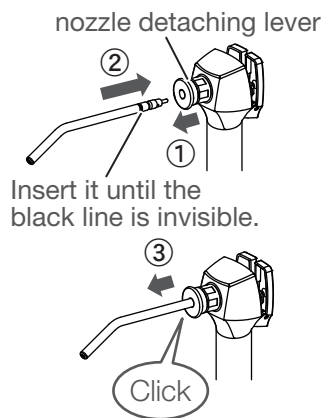

⚠ CAUTION

- Sterilization must be done every after use to patients.
- Do not sterilize the nozzle except for autoclave sterilization. Autoclave sterilizer in compliance with Class B is recommended.
- Sterilization temperature is 135°C or less.
- Dry naturally if the temperature for drying process is to exceed 135°C.
- If damage occurs to the sterilization bag, discard and sterilize again using a new sterilization bag.

Storage method: After sterilization, store the nozzle in the sterilization bag in a dark, cool place.

Example of attaching nozzle

Good example

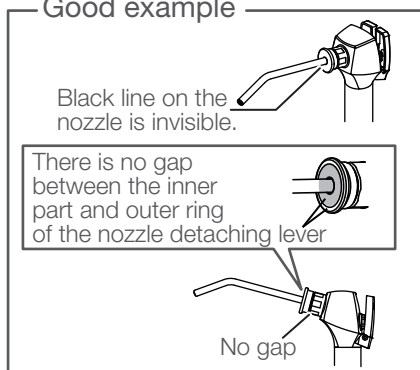

(4) Attaching the nozzle

- A. Pull the ① nozzle detaching lever and insert the nozzle until ② the black line is invisible shown in the left figure.
- B. Release the nozzle detaching lever and ③ pull the nozzle a little. It clicks and locked.
- C. After the nozzle is attached, confirm that the nozzle cannot be detached when pulling it. Follow the example of attaching nozzle shown in the figure, and check the nozzle is securely attached.

⚠ WARNING

If SYR-20 3way syringe is used with its nozzle not securely attached, it may burst out when spraying water or air, and may harm users or other people.

Confirm that the nozzle is securely attached before its use.

Bad example

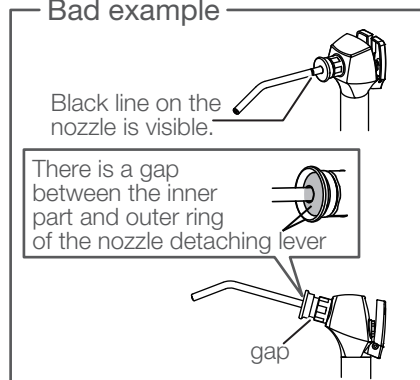

6 Maintenance and Cleaning

6-10 Handpiece hose

Tubings and hoses can be cleaned with FD366 manufactured by Dürr.

6-11 Air filter drain valve

Empty any water that has collected in the air filter at least once a week.

After closing the drain valve knob, water remained in the tube may come out. Wipe the water with cloth to prevent the water from coming out. If any water gets into the air line, it may cause a failure of the product.

CELEB Chair

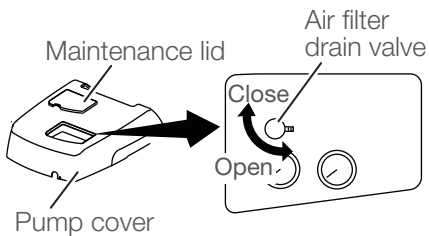

CELEB Chair (EURUS TYPE)

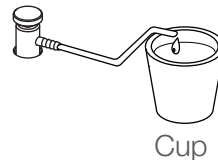
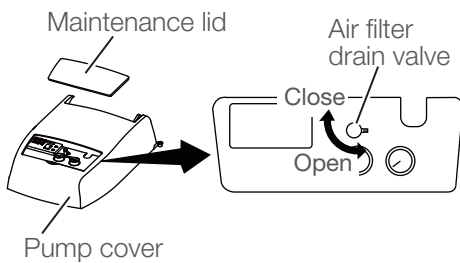

PEDESTAL TYPE

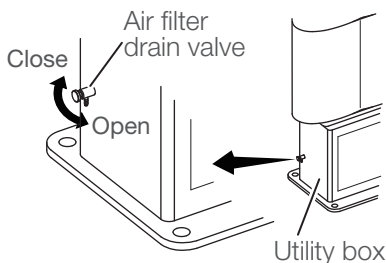

CELEB Chair

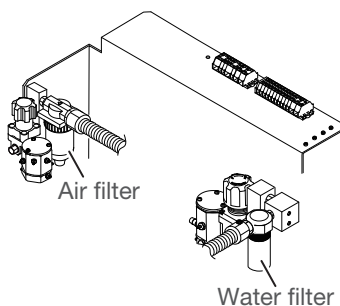

CELEB Chair (EURUS TYPE)

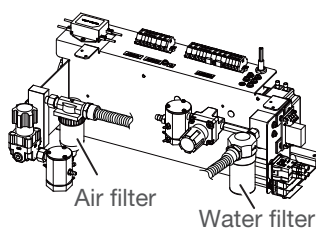

6-12 Filter replacement

The water filter in the junction box needs to be replaced at least once a year.

The air filter in the junction box needs to be replaced at least once every three years.

Contact your local authorized Belmont dealer.

6 Maintenance and Cleaning

6-13 Maintenance and inspection

Notes on daily maintenance and inspection (by the user)

It is the responsibility of the user (medical institution) to ensure that the medical device is correctly maintained and inspected. To ensure safe use of this product, the unit must be inspected at the specified intervals as described in the table below:

No	Inspection item	Inspection	Inspection procedure and criteria	Outcome if inspection is not conducted	Maintenance required when the inspection criterion is not satisfied
1	Check the cancel function	Before consulting hours	Make sure the chair movement stops by any of the following actions. ①When foot controller pedal is depressed. ②During chair auto movement, press for any chair operation switch. ③While setup is in progress with function switch on the doctor membrane switch panel. ④When the cuspidor bowl is turned to patient side (Pedestal type)	The chair unexpectedly moves during procedure, resulting in an injury. The patients may be caught between the doctor unit and the chair, resulting in an accident.	If the chair does not stop, please contact your local authorized Belmont dealer.
2	Check for water, air and oil leaks	Before consulting hours	Check that no water, air or oil leaks out from the product.	The product does not function properly, preventing proper treatment or procedure.	If water, air or oil leaks out, please contact your local authorized Belmont dealer.
3	Cupfiller	Before consulting hours	When a paper cup is placed on the cupfiller, the cup shall be detected and cupfilling shall be executed. * Malfunction may arise if the cup is of another material grade (such as stainless steel and plastics) or if the paper cup is of dark color or pattern.	Cupfilling may not be executed.	please contact your local authorized Belmont dealer.
4	Check the functioning of each handpiece	Before consulting hours	<ul style="list-style-type: none"> • Check that the turbine rotates properly and that the correct quantities of water and air are supplied. • Check that the micromotor rotates properly and that the correct quantity of water is supplied. • Check that the ultrasonic scaler vibrates properly and that the correct quantity of water is supplied. • Check that the correct quantities of water and air are supplied from syringe. 	The patient may receive an injury to their mouth, or the handpiece may malfunction.	Adjust the quantity of water or air. For other failures, please refer to the Instructions for Use for the respective handpieces. If the problem still persists, please contact your local authorized Belmont dealer.
5	Check the correct burr for the turbine, air motor, and micromotor is mounted.	Before each patient	Check that the correct burr is securely mounted. Make sure you refer to the Instructions for Use for the turbine, air motor and micromotor. Check that the burr is free of any defect (damage or deformation).	The burr will not rotate freely, resulting in an accident.	If the burr is damaged, deformed or has some other defect, replace the burr by following the Instructions for Use for the turbine, air motor and micromotor.
6	Check the scaler tip	Before each patient	Check that the correct tip is securely mounted and properly used. Refer to the Instructions for Use for the scaler. Check that the tip is free from any defect (wear or deformation).	The tip will not vibrate properly, resulting in an accident.	If the tip is worn or deformed, replace it by following the Instructions for Use for the scaler. For other defects, please contact your local authorized Belmont dealer.

6 Maintenance and Cleaning

No	Inspection item	Inspection	Inspection procedure and criteria	Outcome if inspection is not conducted	Maintenance required when the inspection criterion is not satisfied
6	Debris in the micromotor	After consulting hours	Check that no excess oil from the handpiece adheres to the motor unit.	The motor unit may not function properly, resulting in a malfunction.	Follow the Instructions for Use for the micromotor to maintain it.
7	Maintenance HVE/ Saliva ejector	After consulting hours	Wash the suction lines	Suction is defective.	Wash the suction lines. [Refer:6 Maintenance and Cleaning]
8	Check the functioning of lever (syringe)	Before consulting hours	Water, air, and spray come out by pressing A lever and W lever. No wobbliness is observed when pressing the lever.	The product does not function properly, preventing proper treatment or procedure.	Contact your local authorized Belmont dealer.
9	Check for the lock of the nozzle (syringe)	Before each patient	Check that the nozzle is securely locked. Check that the locked nozzle does not detach when pulling it.	The nozzle may burst out and harm users or other people.	Securely lock the nozzle. When any malfunction is observed, please contact your local authorized Belmont dealer.
10	Maintenance Cuspidor bowl	After consulting hours	Check that the cuspidor bowl does not contain any dirt (or excrescence). Check that no dirt has collected on the dirt filter.	Draining is defective.	Clean the cuspidor bowl and dirt filter. [Refer:6 Maintenance and Cleaning]
11	Maintenance Solid collector	After consulting hours	Check that no dirt has collected on the solid collector.	Suction power of the HVE or saliva ejector has decreased.	Clean the filter. [Refer:6 Maintenance and Cleaning]
12	Maintenance Exterior	After consulting hours	Check that no chemical solution or dirty water adheres to or remains on the exterior of the product.	Any liquid remaining will cause discoloration or change the properties of the exterior or cause metal parts to rust.	Clean it. [Refer:6 Maintenance and Cleaning]
13	Check the main switch and main water valve	After consulting hours	Check that the main switch is turned off, and the air main valve is closed .	The product will not normally work and troubles may arise.	Contact your local authorized Belmont dealer.
14	Movable parts of the product	Once a week	When operating the product, check that no movable parts emit any abnormal noise.	The product does not function properly, preventing proper treatment or procedure.	If any movable parts emit an abnormal noise, please contact your local authorized Belmont dealer.
15	Maintenance Drain valve	Once a week	Drain water from the drain valve on the air filter.	Water enters the air line, resulting in a malfunction.	Always drain the air filter. [Refer:6 Maintenance and Cleaning]
16	Check water and pneumatic pressures	Once a month	Check the water and pneumatic pressures using the pressure gauge on the maintenance panel. Main water pressure : 0.2MPa Main air pressure : 0.5MPa	The product does not function properly, preventing proper treatment or procedure.	If the pressure is out of the range of the main water pressure/main air pressure, please contact your local authorized Belmont dealer.
17	Check the doctor unit	Once a month	The doctor table is level and stops at the specified position.	Objects fall from the doctor table, resulting in an injury or accident.	If the doctor table is not level or does not stop at the specified position, please contact your local authorized Belmont dealer.
18	Oil mist separator	Once a month	The drain oil does not reach the line on the oil mist separator.	The handpiece may not function properly due to an exhaust failure.	Empty the oil. [Refer:6 Maintenance and Cleaning]



WARNING

Always refer to this Guide and the Instructions for Use supplied with each device (such as the dental light and handpieces) before conducting daily maintenance and inspection. If you do not conduct daily maintenance or inspection, use of the product may result in injury or damage to nearby devices.

Notes for periodic inspection

The product contains parts that stop functioning or wear depending on the use frequency, and therefore it is important to carry out maintenance in a periodic inspection once a year (including replacement of consumables) and safety checks. Service parts required for the periodic inspection (including consumables) are listed in the table below. However, depending on the specifications of your device, there may be alternative parts available that differ from those listed in the table below.

Maintenance and inspection can be outsourced to qualified persons such as authorized repairers of medical devices. If you have any question about periodic inspection, contact your local authorized Belmont dealer.

List of service parts required for the periodic inspection

Part name	Standard service life	Part name	Standard service life
HVE body	3 years	Regulator	3 years
Saliva ejector body	3 years	Valves	3 years
Foot controller	5 years	Switches	5 years
Water supply hose	3 years	Film viewer body part	5 years
Drain hose	3 years	Pressure gauge	3 years
Air supply hose	3 years	Arm section of moving part	7 years
Electric wiring of moving part	5 years	Control PCBs.	5 years

List of consumables required for periodic inspection

Part name	Part name
O-ring, Packing, Diaphragm	Suction hose
Slide knob (HVE)	Saliva ejector hose
HVE Tip	Filter for oil mist separator
Handpiece tubings	Filter (Air & Water)

WARNING

Always entrust periodic inspection to your local authorized Belmont dealer.

If you do not carry out periodic inspection, use of the product may cause injury or damage to nearby devices.

6-14 Detachable parts

Part name	Part name
Handpiece	HVE tip
Handpiece hose	Solid collector lid
Cuspidor bowl	Solid collector filter
Drain cap	Water service coupler
Basket strainer	Air service coupler
Cupfiller base	Syringe nozzle
Cupfiller nozzle	Syringe body
HVE	Oil mist separator
Saliva ejector	

6-15 Storage method

If the product is not used for an extended period of time after consulting hours or during holidays, make sure you observe the precautions below:

1. Always turn off the main switch after consulting hours.
(This is to stop supply of air, water, and electric power.)
Make it a habit to do this to prevent water leak and electrical accidents.
2. After consulting hours, turn the water main valve knob counterclockwise to the vertical position to close the water main valve. Make it a habit to do this to prevent accidents by water leaks.
3. Turn off the breaker for the compressor, and discharge air.
(Also make sure you have turned off the power.)
4. Turn off the breaker for the vacuum pump.
(Also make sure you have turned off the power.)
5. Turn off the breaker for the device in the clinic. (Also make sure you have turned off the power.)
6. Set the chair to the lowest position and the backrest to the most reclined position.

7-1 After-sales service

When you request for repair

Refer to 'Troubleshooting' before you check the device. If the problem persists, turn off the main switch, and contact your local authorized Belmont dealer to request a repair.

7-2 Service life

The service life of this product is 10 years on condition that maintenance and inspection are properly conducted [according to our self-certification (our data)].

However, the standard service lives of service parts that require periodic inspection vary according to the part.

7-3 Period of Parts Retention

We hold service parts such as consumables for products for 10 years from the time of launch.

* Service parts are parts required for repair to return the product to the original state and functions or to maintain its functions.

8 Troubleshooting

If you encounter any of the problems listed below, take the countermeasures described below before requesting a repair. If the problem persists even after troubleshooting, stop using the product immediately, turn off the main switch, and contact your local authorized Belmont dealer.

Phenomenon	Please check	Remedy
The product does not work at all.	Is the main switch turned on?	Turn on the main switch.
	Is the power to the compressor turned on?	Turn on the power.
	Is the breaker for the device on the switch-board of the dentist's office turned on?	Turn on the breaker for the device.
No air is being supplied.	Is the power to the compressor turned on?	Turn on the power.
	Is the knob that controls the air supply to the syringe or other parts closed?	Open the air supply control knob. [Page 54,60]
No water is being supplied.	Is the water supply control knob to the handpiece or syringe closed?	Open the water supply control knob. [Page 54,60]
The HVE or saliva ejector does not activate the suction function.	Is the power to the vacuum pump turned on?	Turn on the power.
	Is the solid collector filter dirty?	Clean the filter. [Page 69]
	Is the solid collector filter properly attached?	Attach the solid collector properly. [Page 69]
Water keeps running from the cupfiller and doesn't stop. Water doesn't come out of the cupfiller.	Is there any dirt or droplet on the surface of cupfiller sensor?	Turn off the main switch and clean the surface of the cupfiller sensor.

9 Consumables

Consumables are parts that will normally wear or deteriorate, change their appearance, or become damaged after use. Please note that repair or replacement of consumables are not covered by the warranty and will be charged for.

(* Degree of wear, deterioration or damage and timing for replacement depends on the use environment and conditions at the customer's premises.)

Consumables (Parts listed below are out of the guarantee coverage and charged parts.)

[Reference] List of service parts required for the periodic inspection.



TAKARA COMPANY EUROPE GmbH

Industriestrasse 21, 61381
Friedrichsdorf, Germany



Albo-Healthcare GmbH

Alte Steinhäuserstrasse 19
CH-6330 Cham

 **Belmont**

TAKARA BELMONT CORPORATION

2-1-1, Higashishinsaibashi, Chuo-ku, Osaka, 542-0083, Japan

TEL : +81-6-6213-5945

FAX : +81-6-6212-3680

