

DENTAL CHAIR (CONTOUR TYPE)
INSTRUCTIONS FOR USE

Dear Customers

Dear Customers

Thank you for purchasing our product.

This booklet explains how to use DENTAL CHAIR (CONTOUR TYPE). Before using DENTAL CHAIR (CONTOUR TYPE), carefully read the operating instructions and make sure to use the product correctly. Using the product without reading these instructions may lead to an accident.

This document describes the full version of the system. It may therefore cover components that are not included in the system you purchased.

This specification is subject to change without notice.

2024-09-01 (5th edition)	
REF	1E07X8E0

Dear Customers

1 General Information

- 1-1 Intended Use of the Product
- 1-2 Compliance with Regulation and Directive
- 1-3 Declaration of Conformity
- 1-4 How to Dispose of the Device
- 1-5 Recommendation to User
- 1-6 Symbols
- 1-7 Technical Description

2 Safety Consideration

- 2-1 Risk Level Interpretation
- 2-2 Safety Precautions
 - 2-2-1 Points to remember when operating the product
- 2-3 EMC Information
- 2-4 Devices Connectable to the Product

3 Precautions for Use

- 3-1 Operating Precautions
- 3-2 Precautions for Using Synthetic Leathers

4 Specifications and Operation

- 4-1 CLESTA II CHAIR (EURUS TYPE) / CELEB CHAIR (EURUS TYPE)
 - 4-1-1 Specifications
 - 4-1-2 Dimensions
 - 4-1-3 Name of Each Part
 - 4-1-3-1 Chair
 - 4-1-3-2 Headrest
 - 4-1-3-3 Junction Unit
 - 4-1-4 Operation
 - 4-1-4-1 Prepatation Before Use
 - 4-1-4-2 After use
 - 4-1-4-3 Raising/lowering the chair and raising/reclining the backrest (manual operation)
 - 4-1-4-4 Moving the chair to the preset position (automatic operation)
 - 4-1-4-5 Operating the headrest (manual type)
 - 4-1-4-6 Turning the armrest
 - 4-1-4-7 Cancellation function
 - 4-1-4-8 Chair lock function
 - 4-1-4-9 Setting the treatment and entry/exit positions
 - 4-1-4-10 Setting the mouth rinsing position

Table of Contents

- 4-2 CLESTA II CHAIR / CELEB CHAIR
 - 4-2-1 Specifications
 - 4-2-2 Dimensions
 - 4-2-3 Name of Each Part
 - 4-2-4 Operation
 - 4-2-4-1 Preparation Before Use
 - 4-2-4-2 After use
 - 4-2-4-3 Raising/lowering the chair and raising/reclining the backrest (manual operation)
 - 4-2-4-4 Moving the chair to the preset position (automatic operation)
 - 4-2-4-5 Headrest
 - 4-2-4-6 Double Articulating Headrest (Optional)
 - 4-2-4-7 Turning the armrest
 - 4-2-4-8 Cancellation function
 - 4-2-4-9 Safety Lock Device
 - 4-2-4-10 Auto Mode Position Adjustment

- 4-3 CLESTA eIII CHAIR
 - 4-3-1 Specifications
 - 4-3-2 Dimensions
 - 4-3-3 Name of Each Part
 - 4-3-4 Operation
 - 4-3-4-1 Preparation Before Use
 - 4-3-4-2 After use
 - 4-3-4-3 Raising/lowering the chair and raising/reclining the backrest (manual operation)
 - 4-3-4-4 Moving the chair to the preset position (automatic operation)
 - 4-3-4-5 Headrest
 - 4-3-4-6 Double Articulating Headrest (Optional)
 - 4-3-4-7 Turning the armrest
 - 4-3-4-8 Cancellation function
 - 4-3-4-9 Safety Lock Device
 - 4-3-4-10 Auto Mode Position Adjustment

- 4-4 CLESTA eIII CHAIR (SWING TYPE)
 - 4-4-1 Specifications
 - 4-4-2 Dimensions
 - 4-4-3 Name of Each Part
 - 4-4-4 Operation
 - 4-4-4-1 Preparation Before Use
 - 4-4-4-2 After use
 - 4-4-4-3 Raising/lowering the chair and raising/reclining the backrest (manual operation)
 - 4-4-4-4 Moving the chair to the preset position (automatic operation)
 - 4-4-4-5 Headrest
 - 4-4-4-6 Turning the armrest
 - 4-4-4-7 Cancellation function
 - 4-4-4-8 Safety Lock Device
 - 4-4-4-9 Auto Mode Position Adjustment

- 4-5 PROGRES
 - 4-5-1 Specifications
 - 4-5-2 Dimensions
 - 4-5-3 Name of Each Part
 - 4-5-4 Operation
 - 4-5-4-1 Preparation
 - 4-5-4-2 After use
 - 4-5-4-3 Raising/lowering the chair and raising/reclining the backrest (manual operation)
 - 4-5-4-4 Moving the chair to the preset position (automatic operation)
 - 4-5-4-5 Headrest
 - 4-5-4-6 Chair Rotation
 - 4-5-4-7 Cancellation function
 - 4-5-4-8 Safety Lock Device
 - 4-5-4-9 Auto Mode Position Adjustment

5 Maintenance and Cleaning

- 5-1 Exterior
 - 5-1-1 Cleaning and disinfecting the surfaces
- 5-2 Leather part
- 5-3 Maintenance and inspection
 - 5-3-1 Notes on daily maintenance and inspection (by the user)
 - 5-3-2 Notes for periodic inspection
- 5-4 Storage method

6 Maintenance by Service Engineers

- 6-1 After-sales service
- 6-2 Service life
- 6-3 Period of Parts Retention

7 Troubleshooting

- 7-1 Troubleshooting

8 Accessories and Consumables

- 8-1 Accessories
- 8-2 Consumables

1-1 Intended Use of the Product

This product is an active therapeutic device intended for the exclusive use for diagnoses, treatments and relative procedures of dentistry. The product must be operated or handled by the qualified dentists or by dental staffs under the supervision of the dentist. Such dentists or dental staffs should instruct and/or assist the patients to approach to and leave from the product. Patients should not be allowed to operate or handle the product unless he/she is so instructed.

1-2 Compliance with Regulation and Directive

This product complies with MDR (EU) 2017/745 and RoHS Directive 2011/65/EU.

1-3 Declaration of Conformity

We hereby declare that the product listed below complies with the essential requirements of the MDR (EU) 2017/745 and RoHS Directive: 2011/65/EU based on category 8 of Annex I.

Product : DENTAL CHAIR (CLASS I)
Model : CLESTA II CHAIR / CELEB CHAIR
CLESTA eIII CHAIR
PROGRES

" CLASS I " has been defined by the rule 13 of MDR Annex VIII. The product has been designed and manufactured in accordance with the European standards as the listed in the Declaration of Conformity.

1-4 How to Dispose of the Device

























When disposing of this product and parts replaced, carefully take infection control measures, pay attention to physical hazards such as from sharps, and handle them properly in accordance with the relevant laws and regulations (including local ordinances). In the EU area, EU Directive 2012/19/EU (Directive on Waste Electrical and Electronic Equipment [WEEE Directive]) applies to this product. Environment-conscious recycling/disposal is mandatory under this Directive.

1-5 Recommendation to User













A notice to the user and/or patient that any serious incident that has occurred in relation to the device should be reported to the manufacturer and the competent authority of the Member State in which the user and/or patient is established.

1 General Information

1-6 Symbols

	Stick switch for manual operation		Stick switch for automatic operation
	Caution		General warning sign
	Generally prohibited activity		Disassembly, repair or modification prohibited
	Instructions for mandatory actions in general		Follow instructions for use
	Type B Applied Parts contacting the patient's body surface only		Alternating current
	Manufacturing date and country		Catalog number
	Name and address of the manufacturer		Serial number
	Separate collection of electrical and electronic equipment		European Authorized Representative
	Compliance with MDR (EU) 2017/745, RoHS Directive 2011/65/EU		Chair last position
	Switch (O N)		Switch (O F F)
	Chair auto return		Chair preset1
	Chair preset2		To raise the chair

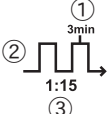
1 General Information

	To Recline the backrest		To lower the chair
	To raise the backrest		Protective earthing
	Functional earthing		Chair manual control
	Medical Device		Dental patient chair
	Rated voltage		Rated input
	<ul style="list-style-type: none"> ① Maximum activation time ② Non-continuous operation ③ Duty cycle 		Swiss Authorized Representative
	Electronic instructions for use		

1-7 Technical Description

The following are explained in the documents listed below:

Item	Document
How to install this product	Installation instructions
Wiring/plumbing	Installation instructions

2-1 Risk Level Interpretation

Precautions before use

Make sure to carefully read the Safety Precautions and Operating Precautions and use the product correctly.

These precautions are intended to ensure the safe use of the product and prevent harm or damage to users or other people.

According to the magnitude of harm and damage and the degree of urgency, an incident that may be caused by misuse of the product is classified into one of the following categories: CONTRAINDICATION, WARNING, and CAUTION.

All of these categories are important for safety. Always follow the instructions provided.

We assume no responsibility for any accident due to failure to follow the Safety Precautions or Operating Precautions even in the event of harm or damage to users or other persons.

In such case, users or other persons who use the product without observing the Safety Precautions and Operating Precautions are responsible for any harm or damage incurred.

The graphical symbols are explained in detail below.

Once you have fully understood this explanation, read the text.

2 Safety Consideration

Classification by degree of harm or damage and urgency

CONTRAINDICATION

Use of the product without regard to this indication will create a hazardous condition that may result in death or serious injury.

WARNING

Improper handling of the product without regard to this indication will create a hazardous condition that may result in death or serious injury.

CAUTION

Improper handling of the product without regard to this indication will create a potentially hazardous condition that may result in moderate or slight injury or property damage.

The following graphical symbols are used to explain your responsibilities for using the product safely:

Graphical symbols for prohibited activity



Generally prohibited activity



Disassembly, repair or modification prohibited

Graphical symbol for mandatory instructions



Instructions for mandatory actions in general

2-2 Safety Precautions

CONTRAINDICATION

Installing or transferring the product



Precautions regarding installation

Do not install the product near electromagnetic sources such as communication facilities or elevators.

Malfunction of this product may occur in the presence of electromagnetic interference waves.

Use and maintenance of the product



Do not use the equipment in an explosive atmosphere (e.g., in the presence of inflammable gases).

Improper use in such an atmosphere may cause injury or fire.

Use with caution in the presence of electromagnetic waves.

Do not use equipment generating electromagnetic waves, such as mobile phones, around this product.

Malfunction of this product may occur.

Be sure to turn off the main switch (or the main switch of the unit) when HF surgical equipment is in use.

Be sure to turn off the main switch (or the main switch of the unit) when HF surgical equipment is in use because the noise generated from HF surgical equipment may cause incorrect operation of this product.



Never disassemble, repair or modify the product.

Individuals other than your local authorized Belmont dealer should not disassemble or repair this product.

This could lead to an accident, failure, electric shock, or fire.

Never modify the product as it is extremely dangerous.

2 Safety Consideration

WARNING

Installing or transferring the product



Precautions for installation

Ask your local authorized Belmont dealer to install the product.

Make sure to place the product on a firm and flat floor. Placing the equipment on a non-flat floor may cause it to fall.

Be sure to ground the product securely. (Ask a professional to ground the product.)

Failure or electric leak may result in electric shock.

To avoid the risk of electric shock, this equipment must only be connected to a supply mains with protective earth.

This equipment must be connected to an appropriate power source.

Use and maintenance of the product



Keep moving parts of the product away from patients' and users' hands, fingers, and bodies.

Hands, fingers or bodies may become caught in the product, causing injury.

The patient must not lie on his/her stomach, kneel in the formal seiza position (with his/her buttocks on his/her heels), or sit on the product with a child in his/her arms.

The chair may move unexpectedly, causing injury.

The patient must not sit on the edge of the seat.

The chair may fall or move unexpectedly, causing injury or damage to peripheral devices.

The patient must not sit in an area other than the designated location.

Excessive load must not be applied to the product.

The patient must not sit on the headrest, armrest or backrest.

This may cause injury due to falling, or damage to peripheral devices.

Do not wash the product with water.

This may cause failure or electric shock.

2 Safety Consideration

Use and maintenance of the product



The patient should clasp his/her hands.



The patient should place his/her feet side by side.

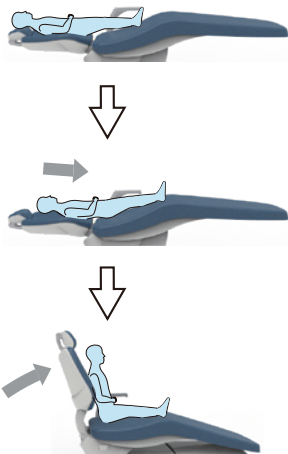

WARNING

Remove the patient's glasses and any accessories (such as a necklace or bracelets) before treatment.

Failure to follow this instruction may hamper treatment and lead to an accident.

Points to remember when a patient sits on the chair

As shown in the figure on the left, instruct the patient to sit on the chair and make sure his/her body fits into the chair.

Ensure that the patient maintains a good posture before moving the chair.

For a young child, the buttocks should be placed on the seat when raising the backrest.

Pay attention to patients and children.

Keep your eyes on the patient when this product is in use.

Patients (especially children) may touch the control switch or system inadvertently, leading to an accident due to incorrect operation of the product.

Keep children away from this product except when giving treatment.

Use and maintenance of the product



WARNING

Precautions for getting on and off the product.

When the patient gets on or off the chair, the chair should always be at entry/exit position, which is the lowest position with the backrest fully raised.

Before moving a patient from a wheelchair to the product or vice versa, ensure that no obstacles (e.g., foot controllers) are situated around the wheelchair or the caregiver.

Contact of the feet or the wheelchair castors with obstacles (such as foot controllers) may cause injury or damage to peripheral devices.

When the patient is moved from a wheelchair to the product or vice versa, he/she must be carefully monitored to prevent falling.

If the patient has to get off the product at a position other than the designated position for getting on and off the product due to power failure or in the event of an emergency, he/she must be carefully monitored to prevent falling.

Precautions when raising/lowering the backrest

Before lowering the backrest, ensure that the patient's arm or hand is not sandwiched between the backrest and the seat.

Before raising the backrest, ensure that the patient's arm or hand is not sandwiched between the backrest and the armrest.

Precautions for operating the chair and automatic operation

Before and during the chair operation, pay close attention to the operation range (seat raising/lowering direction and backrest lowering/raising direction), and ensure that the chair does not contact any body parts, hands or feet, or objects.

Before operating the chair, ensure that the patient is sitting in the correct position, and keep your eyes on him/her when the chair is in use.

Precautions when using the headrest (manual)

During the headrest operation, ensure that your hands, fingers, or hair do not become caught in the control lever and are not sandwiched between the headrest and the backrest.

Pay close attention to a patient who has a cardiac pacemaker or defibrillator implanted.

If any abnormality occurs, immediately turn off the main switch (or the main switch of the unit) and discontinue use of the product.

The product may affect the function of the pacemaker or defibrillator, leading to an accident.

Use and maintenance of the product



WARNING

Prohibition of using this equipment adjacent to or stacked with other electronic equipment

Use of this equipment adjacent to or stacked with other equipment should be avoided because it could result in improper operation. If such use is necessary, this equipment and the other equipment should be observed to verify that they are operating normally.

Prohibition of placing portable RF communications equipment adjacent to this product

Portable RF communications equipment (including peripherals such as antenna cables and external antennas) should be used no closer than 30 cm (12 inches) to any part of CLESTA II CHAIR (EURUS TYPE) / CELEB CHAIR (EURUS TYPE) / CLESTA II CHAIR / CELEB CHAIR / CLESTA eIII CHAIR / CLESTA eIII CHAIR (SWING TYPE) / PROGRES, including cables specified by the manufacturer. Otherwise, degradation of the performance of this equipment could result.

Immediately wipe off any water spillage or leakage on the floor.

Decreased strength of the floor may cause the product to fall, leading to injury or damage to peripheral devices.

Clean the product thoroughly.

Poor cleaning may cause bacteria to grow, posing a health risk.

Be sure to conduct maintenance.

Use of the product without maintenance may cause injury or damage to peripheral devices.

Discontinue use of the product if it is broken.

In the case of a broken product, immediately discontinue use and turn off the main switch (or the main switch of the unit). Then, ask your local authorized Belmont dealer to repair the product.

2 Safety Consideration

Turn off the main switch (or the main switch of the unit) during cleaning.

Failure to follow this instruction may cause electric shock or ignition. The product may also move unexpectedly, causing injury.

Action taken for power failure

To prevent unexpected operation of the product after recovery from power failure, turn off the main switch (or the main switch of the unit).

Be sure to turn off the breaker for devices when the product is not used for a long period of time.

Make sure to turn off the breaker for devices in a clinic when the product is not used for a long time for reasons such as closing time and non-consultation day.

If the breaker is not turned off, a fire may be caused by a leakage of electricity due to insulation deterioration.

CAUTION

Use and maintenance
of the product



Do not allow a person who exceeds the weight limit to sit on the chair.

Falling or operational failure may occur.

[Reference] Weight limit

Do not hit or rub the product.

This may cause damage to the cover or operational failure.



Ensure that each part operates normally, with no abnormalities detected, before operation.

Always inspect the product for abnormal findings such as loose components, backlash, tilting, vibration, sound, abnormal temperature, or bad odors.

If you feel something is wrong, immediately discontinue use of the product and turn off the main switch. Then, contact your local authorized Belmont dealer.

Read the Instructions for use.

Before use, make sure to carefully read the instructions for use and use the device correctly.

Be sure to operate switches manually.

Make sure to operate the switches manually, except for the foot controller operated by the foot and stick switches. Failure to operate the switches by hand may cause damage or malfunction.

Carefully operate the switches to prevent a mistake.

The operator should pay close attention to people around the product and say something before operation to prevent any errors.

Precautions for armrest rotation

Ensure that no obstacles are placed around the armrest and fingers do not become caught in the armrest.

Do not operate the chair when the armrest is rotated. Before operating the chair, return the armrest to its original position.

2 Safety Consideration

Immediately wipe off any drug solutions or water adhered to the product.

Adherence of drug solutions or water to the product may cause operational failure or electrical leak. If drug solutions or water are adhered, immediately turn off the main switch and wipe them off with a dry, soft cloth.

Turn off the main switch (or the main switch of the unit) at the end of day or during a recess.

Malfunction due to contact with the product will cause damage or injury.

2-2-1 Points to remember when operating the product

Meaning of a symbol

- Point to remember
(locations requiring attention including moving parts, rotating parts, and detachable parts)
- ▷ Point to remember where an emergency stop mechanism is available

Meanings of each point to remember

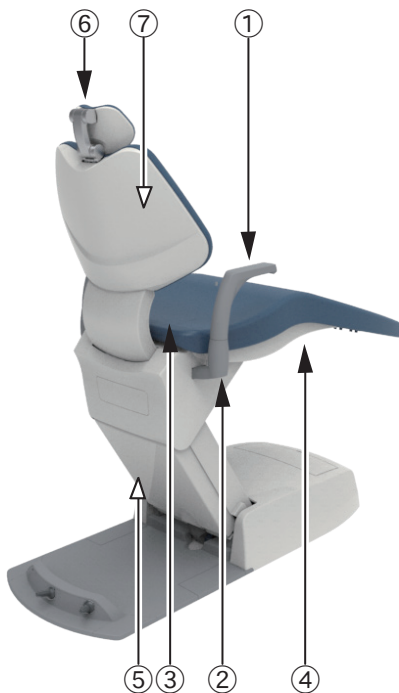

- ① Pay attention to prevent body parts or objects from becoming caught in the armrest (when rotating). Do not operate the chair when the armrest is rotated.
- ② Pay attention to prevent body parts or objects from becoming caught in the armrest (when lowering the chair). Do not place the body parts or objects at the the armrerst bracket when lowering the chair.
- ③ Pay attention to prevent body parts or objects from becoming caught in the backrest moving parts. Do not sandwich your hands or feet between the backrest and the seat.
- ④ Pay attention to prevent body parts or objects from becoming caught in the bottom of the seat. Do not place your hands or feet in the bottom of the seat.

2 Safety Consideration



- ⑤ Pay attention to prevent body parts or objects from becoming caught in the rear link cover. Do not place the body parts or objects between the rear link cover and base plate.
- ⑥ Pay attention to prevent body parts or objects from becoming caught in the headrest moving part. Ensure that your fingers and hair do not become caught in the headrest moving part.
- ⑦ Pay attention to prevent contact with the backrest. Before operating the backrest, ensure that no obstacles are placed around the backrest.

WARNING

When operating the chair, do not place the body parts or objects around the moving parts. This may cause injury.

2-3 EMC Information

This product complies with EMC Standard EN60601-1-2:2015.

1. Precautions regarding EMC and compliance with accompanying documents

Medical electrical equipment requires special precautions regarding EMC and needs to be installed and put into service according to the EMC information provided in this booklet.

2. Effects of RF communication devices

Portable and mobile RF communication devices can affect medical electrical equipment.

3. Installation exclusion environment

Hospitals except for near active HF SURGICAL EQUIPMENT and the RF shielded room of an ME SYSTEM for magnetic resonance imaging, where the intensity of EM DISTURBANCES is high.

4. Electromagnetic emission declaration

Guidance and manufacturer's declaration—electromagnetic emissions		
This product is intended for use in the electromagnetic environment specified below. The customer or user of this product should ensure that it is used in such an environment.		
Emissions test	Compliance	Electromagnetic environment—guidance
RF emissions CISPR 11	Group 1	This product only uses RF energy for its internal functions. Therefore, its RF emissions are very low and are not likely to cause any interference with nearby electronic equipment.
RF emissions CISPR 11	Class B	This product is suitable for use in all establishments, including domestic establishments and those directly connected to the public low-voltage power supply network that supplies buildings used for domestic purposes.
Harmonic emissions IEC 61000-3-2	Class A	
Voltage fluctuations/ Flicker emissions IEC 61000-3-3	Complies	



Use of this equipment adjacent to or stacked with other equipment should be avoided because it could result in improper operation. If such use is necessary, this equipment and the other equipment should be observed to verify that they are operating normally.

5. Electromagnetic immunity declaration 1

Guidance and manufacturer's declaration—electromagnetic immunity			
This product is intended for use in the electromagnetic environment specified below. The customer or user of this product should ensure that it is used in such an environment.			
Immunity test	IEC 60601 test level	Compliance level	Electromagnetic environment—guidance
Electrostatic discharge (ESD) IEC 61000-4-2	±8 kV contact ±15 kV air	±8 kV contact ±15 kV air	Flooring should be wood, concrete, or ceramic tiles. If the floor is covered with synthetic material, the relative humidity should be at least 30%.
Electrical fast transient/burst IEC 61000-4-4	±2 kV for power supply lines ±1 kV for input/output lines	±2 kV for power supply lines ±1 kV for input/output lines	The mains power quality should be that of a typical commercial or hospital environment.
Surge IEC 61000-4-5	±1kV differential mode ±2kV common mode	±1kV differential mode ±2kV common mode	The mains power quality should be that of a typical commercial or hospital environment.
Voltage dips, short interruptions and voltage variations on power supply input lines IEC 61000-4-11	0% UT ; 0.5 cycles 0°, 45°, 90°, 135°, 180°, 225°, 270° and 315° 0% UT ; 1 cycle and 70% UT ; 25/30 cycles at 0°, single phase 0% UT ; 250/300 cycles	0% UT ; 0.5 cycles 0°, 45°, 90°, 135°, 180°, 225°, 270° and 315° 0% UT ; 1 cycle and 70% UT ; 25/30 cycles at 0°, single phase 0% UT ; 250/300 cycles	The mains power quality should be that of a typical commercial or hospital environment. If the user of this product requires continued operation during mains power interruptions, it is recommended that this product be powered from an uninterruptible power supply or a battery.
Power frequency (50/60 Hz) magnetic field IEC 61000-4-8	30A/m	30A/m	Power frequency magnetic fields should be at levels characteristic of a typical location in a typical commercial or hospital environment.
Note UT is the AC mains voltage prior to the application of the test level.			

6. Electromagnetic immunity declaration 2

Guidance and manufacturer's declaration—electromagnetic immunity			
This product is intended for use in the electromagnetic environment specified below. The customer or user of this product should ensure that it is used in such an environment.			
Immunity test	IEC 60601 test level	Compliance level	Electromagnetic environment —guidance
Conducted RF IEC 61000-4-6	3V 0.15MHz-80MHz 6V 0.15MHz-80MHz in ISM and amateur radio bands	3V 0.15MHz-80MHz 6V 0.15MHz-80MHz in ISM and amateur radio bands	Warning: Portable RF communications equipment (including peripherals such as antenna cables and external antennas) should be used no closer than 30 cm (12 inches) to any part of CLESTA II CHAIR (EURUS TYPE) / CELEB CHAIR (EURUS TYPE) / CLESTA II CHAIR / CELEB CHAIR / CLESTA eIII CHAIR / CLESTA eIII CHAIR (SWING TYPE) / PROGRES, including cables specified by the manufacturer. Otherwise, degradation of the performance of this equipment could result.
Radiated RF IEC 61000-4-3	3V/m 80MHz-2.7GHz 80% AM (1 kHz)	3V/m 80MHz-2.7GHz 80% AM (1 kHz)	
Near electromagnetic field caused by RF wireless communication devices IEC61000-4-3	See the table on the next page	See the table on the next page	

7. Essential performance

Unless operated by the chair control switch, the chair will not make any movements except for sounding a buzzer and switching the indicator on/off.

Loss or decline of essential performance may cause the chair to move unexpectedly, causing harm to the patient, operator or people or objects around the patient or operator.



Portable RF communications equipment (including peripherals such as antenna cables and external antennas) should be used no closer than 30 cm(12 inches) to any part of CLESTA II CHAIR (EURUS TYPE) / CELEB CHAIR (EURUS TYPE) / CLESTA II CHAIR / CELEB CHAIR / CLESTA eIII CHAIR / CLESTA eIII CHAIR (SWING TYPE) / PROGRES, including cables specified by the manufacturer. Otherwise, degradation of the performance of this equipment could result.

2 Safety Consideration

Near electromagnetic field caused by RF wireless communication devices

Test frequency (MHz)	Modulation	IEC 60601 test level	IEC 60601 compliance level
385	Pulse modulation ^{a)} 18Hz	27V/m	27V/m
450	Frequency modulation ± 5 kHz shift 1kHz sine wave	28V/m	28V/m
710 745 780	Pulse modulation ^{a)} 217Hz	9V/m	9V/m
810 870 930	Pulse modulation ^{a)} 18Hz	28V/m	28V/m
1720 1845 1970	Pulse modulation ^{a)} 217Hz	28V/m	28V/m
2450	Pulse modulation ^{a)} 217Hz	28V/m	28V/m
5240 5500 5785	Pulse modulation ^{a)} 217Hz	9V/m	9V/m

Note a) The carrier is modulated by a square wave with a 50% duty cycle.

2 Safety Consideration

2-4 Devices Connectable to the Product

Use this product in combination with the unit marked with a circle.

TYPE	Devices connectable			
	CLESTA II	CELEB	CLESTA eIII	CLESTA eIII SWING
CLESTA II CHAIR (EURUS TYPE)	○	/	/	/
CELEB CHAIR (EURUS TYPE)	/	○	/	/
CLESTA II CHAIR	○	/	/	/
CELEB CHAIR	/	○	/	/
CLESTA eIII CHAIR	/	/	○	/
CLESTA eIII CHAIR (SWING TYPE)	/	/	/	○
PROGRES	/	/	/	/

3-1 Operating Precautions

Immediately wipe off any drug solutions adhered to the product.

Otherwise, they may cause deterioration or discoloration.

Do not apply heat to this product.

This may cause deterioration or discoloration.

Discoloration of resin

Resin materials are used in external components of this product. Carefully selected materials are used; however, discoloration may occur for reasons such as natural deterioration or the adherence of drug solutions.

To ensure use of the product for as long as possible, immediately wipe off any drug solutions adhered and avoid sunlight.

Precautions for cleaning the resin cover

For cleaning, do not use cleaning agents containing solvent or abrasives, thinners or oil-based alcohol (butanol and isopropyl alcohol), which may cause cracks.

Do not place objects other than a human being on the seat.

This may cause deformation, tears, or corrosion of the leather.

Use this product only for dental treatment.

This product is patient chair used for dental treatment.

Only a dentist and dental staff are allowed to use this product.

Chair's weight limit

The chair may rise slowly if a person weighs around the maximum lifting capability.

[Reference] Weight limit

Cleaning before and after using

Be sure to clean the product before and after use.

Turn off the power before cleaning.

3-2 Precautions for Using Synthetic Leathers

Adherence of clothing dye

To clean and disinfect the synthetic leathers, wipe the surface with a soft cloth or paper towel moistened with FD360 manufactured by Dürr, and then wipe it with a dry cloth.

Dye may migrate from clothes or belts to the synthetic leathers of the product. If dye is adhered, wipe gently with a soft cloth impregnated with a neutral detergent diluted to about one-tenth with water as soon as possible to prevent penetration. Next, wipe with water and then thoroughly with a dry cloth.

Pay attention to prevent deterioration and dye migration due to contact.

Contact with other resin materials, coated products, solvents, and adhesive tapes may cause changes in the surface gloss, cracks, deformation or abrasion.

Dye may migrate from newspapers or printed matters to the product.

Dye may migrate from printed clothes such as T-shirts or denim clothes to the leathers of this product.

Adherence of benzene, nail polish remover, alcohol, or oil may cause discoloration, surface dissolution, changes in gloss, hardening, softening or abrasion.

Use of a bleaching agent or a sheet cleaned by bleach may cause changes in gloss or discoloration.

Placing the product near a heat source such as a heater may cause deformation or discoloration.

Shield the product from direct sunlight by using a curtain. Direct sunlight may cause surface change, shrinkage, discoloration or fading.

Placing a heavy object on the product for a long time may leave a mark or wrinkle on the synthetic that cannot be removed.

4 Specifications and Operation

4-1 CLESTA II CHAIR (EURUS TYPE) / CELEB CHAIR (EURUS TYPE)

4-1-1 Specifications

Model	AC-ERC2-CD* (* represents single or multiple strings or numbers.)
Classification for protection against electric shock	Class I Equipment
Classification according to the degree of protection against electric shock	Type B Applied Parts(chair upholstered parts/armrest)
Rated voltage	AC230 V
Power frequency	50/60 Hz
Power input	2.0/2.0 A
Fuse	Chair control board 1.25A / 250V (Interrupting capacity: 1500A / 250VAC) Operating speed: Interrupting Size: 5.2 × 20 mm
Operation mode	Non-continuous operation (motor) Maximum operating time, 3 minutes DUTY 1:15
Weight	145 kg
Chair Initial height/stroke	435 mm/365 mm
Chair raising and lowering mechanism	Electrohydraulic
Headrest	Manual
Backrest	Electrohydraulic
Seat	Backrest-linked tilt mechanism
Armrest	Left fixed/Right removed Left fixed/Right rotated Angle of rotation 90°/135°
Upholstered parts	Synthetic leather
Control switch	Stick switch
Usage environment	Temperature 0 ~ 40°C Humidity 10 ~ 95% (No condensation) Air pressure 700 ~ 1060 hPa
Transportation / Storage environment	Temperature -20 ~ 70°C Humidity 10 ~ 95% (No condensation) Air pressure 700 ~ 1060 hPa
Weight limit	200 kg
Adaptation to high-oxygen environment	The product is not suitable for use in a high-oxygen environment.

Refer to the rating plate for the capacity of power supply.

The specification is subject to change without notice.

4 Specifications and Operation

4-1-2 Dimensions

Dimensional drawing (standard values are provided)

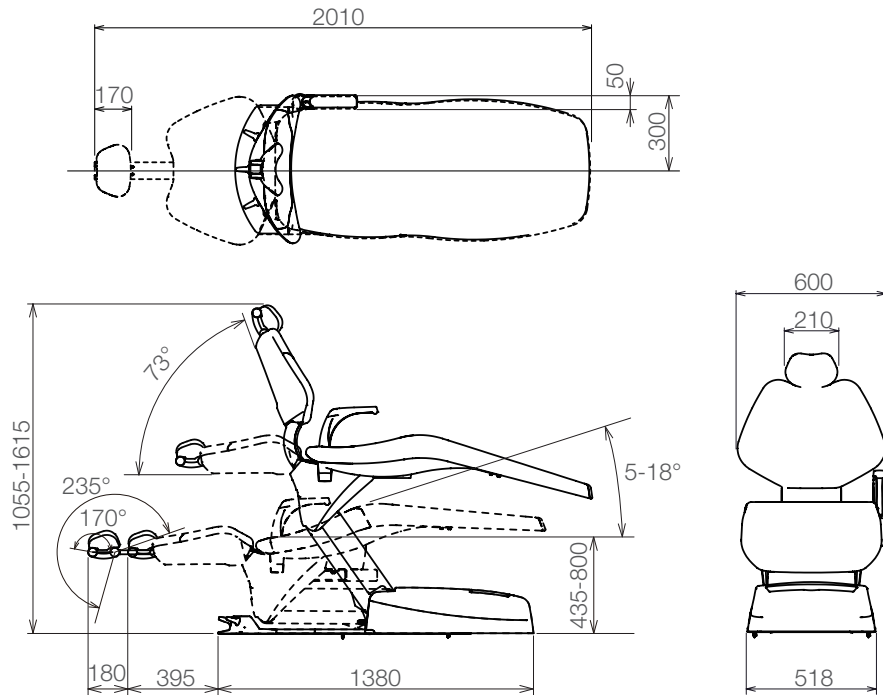

Unit: mm

Tolerance in dimensions: $\pm 10\%$

The specification is subject to change without notice.

4 Specifications and Operation

4-1-3 Name of Each Part

4-1-3-1 Chair

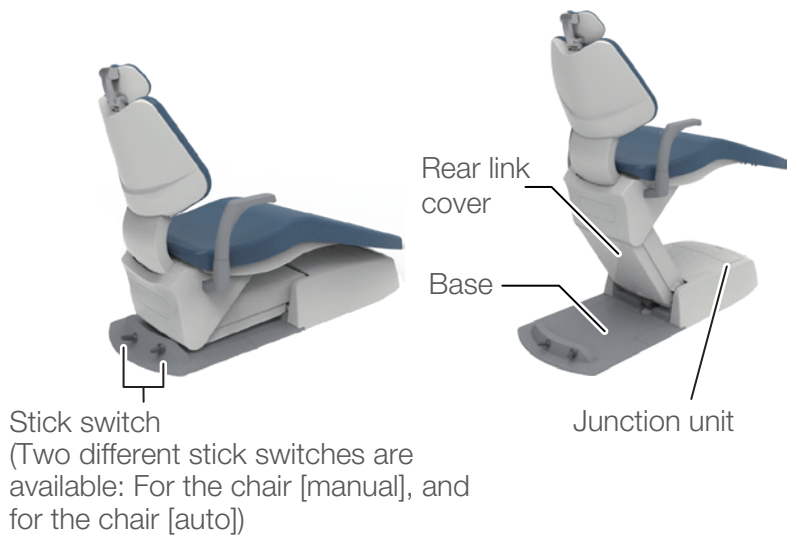
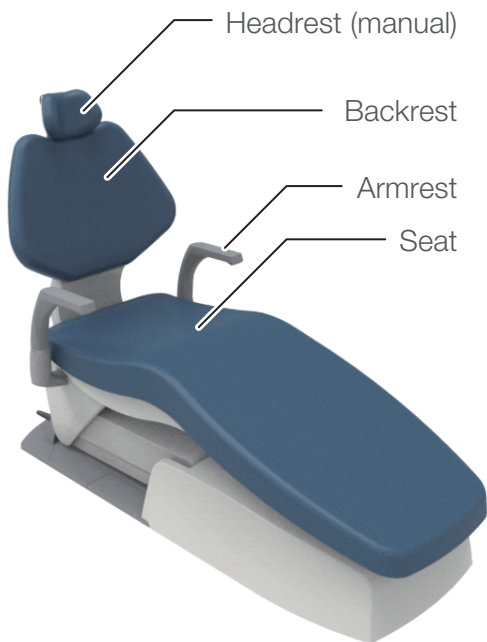

The position or availability of the stick switch may differ according to the specification selected.

4-1-3-2 Headrest Headrest (manual)

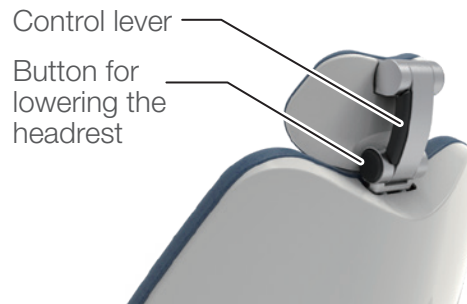

4-1-3-3 Junction Unit

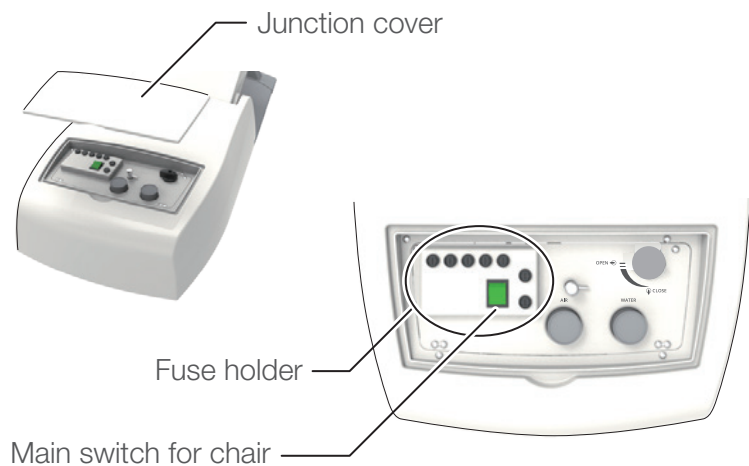

4 Specifications and Operation

4-1-4 Operation

4-1-4-1 Preparation Before Use

Turn on the power for chair

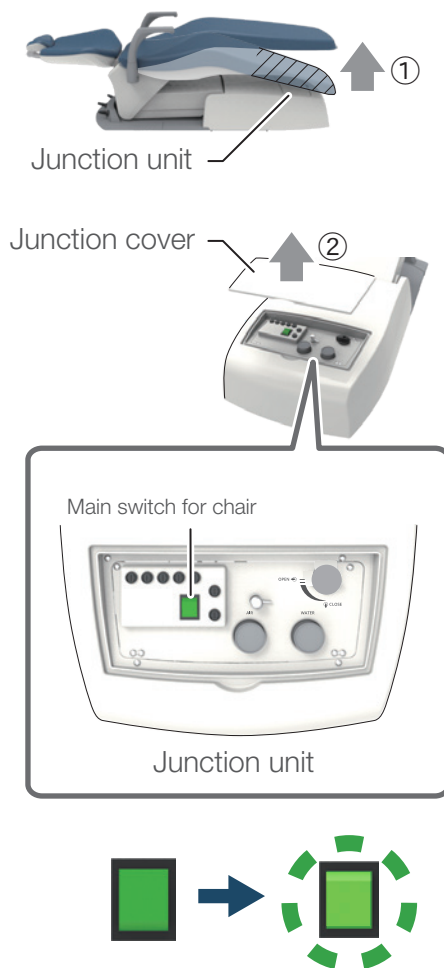

CAUTION

Operate the main switch for chair by hand.

4 Specifications and Operation

4-1-4-2 After use

Turn off the power for chair

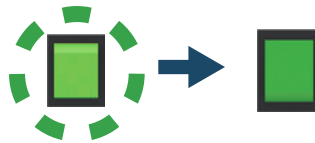
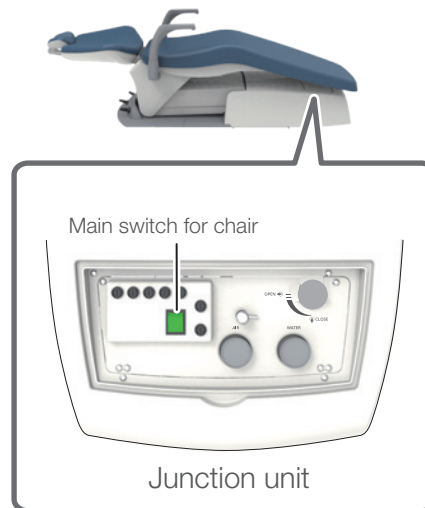

 **CAUTION**

Operate the main switch for chair by hand.

4 Specifications and Operation

4-1-4-3 Raising/lowering the chair and raising/reclining the backrest (manual operation)



Stick switch		Operation
Pushing direction	Label indication	

*The chair is operated while the stick switch is pushed down or the switch is pressed.

WARNING

Before raising/lowering the chair, ensure that the chair does not contact any body parts, hands, feet, or objects.

Before reclining the backrest, confirm that the patient's arm or hand is not placed between the backrest and the seat.

Before raising the backrest, confirm that the patient's arm or hand is not placed between the backrest and the armrest.

[Reference] Precautions when a patient is seated

4 Specifications and Operation

4-1-4-4 Moving the chair to the preset position (automatic operation)



Stick switch		Operation
Pushing direction	Label indication	
		"Treatment position 1".
		"Treatment position 2".
		"Entry/exit position".
		"Mouth rinsing position".
		"Previous position".

Do not press the stick switch for automatic operation for five seconds or longer. If pressed for five seconds or more, a buzzer sound is heard, and the chair position at that point is memorized as a preset position.
 [Reference] Automatic operation setting

WARNING

Before moving the chair, confirm that no human body part, limb, or obstacle is obstructing the chair.

4-1-4-5 Operating the headrest (manual type)

Adjustment of the headrest

The headrest is capable of flexibly adjusting the inclination of the patient's head for treatment in the upper/lower jaw. It is also possible to manually extend/fold the headrest in accordance with the patient's height.

Angle adjustment of the headrest

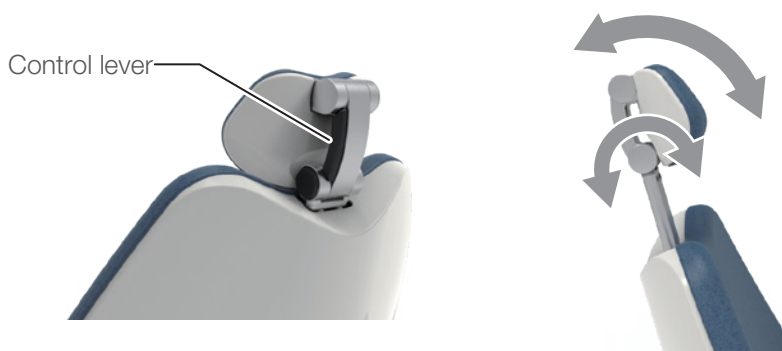

Up/down adjustment of the headrest



Do not apply excessive load or impact to the headrest while it is extended. Do not hit the headrest from above. Otherwise, failure may result.

WARNING

If the chair is to be moved with the backrest reclined while the headrest is extended, confirm that there is no object obstructing or coming into contact with the chair. This may cause damage or injury.

When operating the headrest, be careful not to get the operator's hand or finger caught around the control lever or between the headrest and the backrest.

When adjusting the angle or up/down, be sure to apply the operator's hand to the headrest and support the patient's head. Otherwise, an accident or injury may result.

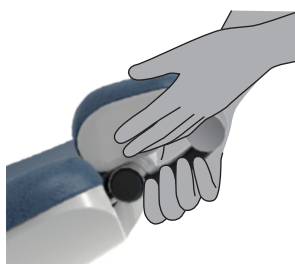

4-1-4-6 Turning the armrest

If the armrest hinders entry/exit or diagnosis, it may be turned backward.
Only the right armrest can be turned.



CAUTION

When turning the armrest, confirm that there is no obstruction.
Operator must be careful not to get their hand or finger caught.

Do not move the chair while the armrest has been turned backward.
Return the armrest to the normal position before moving the chair.

4 Specifications and Operation

4-1-4-7 Cancellation function



To stop the chair movement started by a switch for automatic operation (preset switch, automatic return switch, last position switch, or stick switch for automatic operation), perform one of the following operations.

Operate one of the stick switches (indicated with ○).

4-1-4-8 Chair lock function

When the lock function is activated, the chair movement is stopped. The functions that become locked and the unlocking steps are as follows.

Condition	How to unlock		
During the chair movement, force is applied to the rear link cover in the direction indicated with an arrow	Remove the obstacle that has caused emergency stop, confirm safety, and operate the chair.		
	<table border="1" style="width: 100%; border-collapse: collapse;"> <thead> <tr> <th data-bbox="746 1279 1516 1330" style="background-color: #cccccc;">Locked functions</th> </tr> </thead> <tbody> <tr> <td data-bbox="746 1330 1516 1498"> Automatic operation of the chair Manual operation (lowering, reclining the backrest) </td> </tr> </tbody> </table>	Locked functions	Automatic operation of the chair Manual operation (lowering, reclining the backrest)
Locked functions			
Automatic operation of the chair Manual operation (lowering, reclining the backrest)			

4 Specifications and Operation

4-1-4-9 Setting the treatment and entry/exit positions

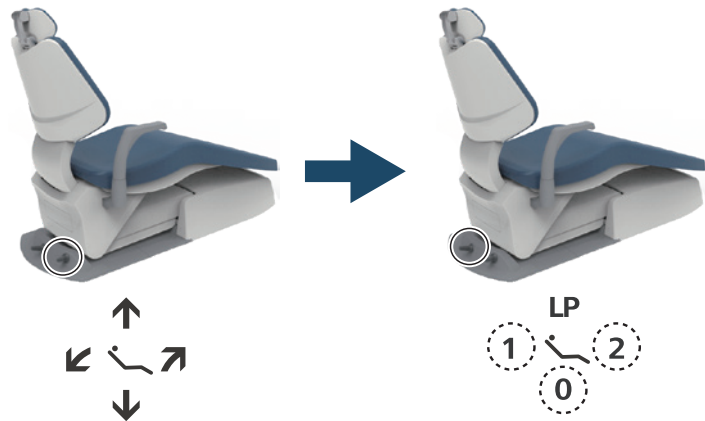

Set the treatment position
by chair manual switch

Keep pressing 5seconds.
1,2: Chair preset position
0:Auto return position

4-1-4-10 Setting the mouth rinsing position

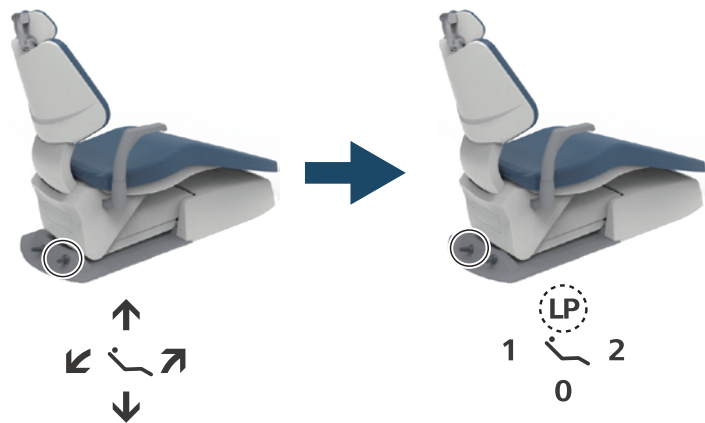

Move the chair to rinsing
position by chair manual switch

Keep pressing 5seconds.
LP: Last position

4 Specifications and Operation

4-2 CLESTA II CHAIR / CELEB CHAIR

4-2-1 Specifications

Model	AC-CL2-C230* AC-CL2-230* (* represents single or multiple strings or numbers.)
Seat Initial Height	410mm
Seat Lifting Stroke	380mm
Backrest Movement	0° ~ 80° above Horizontal
Classification for protection against electric shock	Class I Equipment
Tilting Mechanism	Backrest Synchronized Tilting (5° ~ 11° above Horizontal)
Auto Movements	2-Preset, 1-Last Position Memory and 1-Auto Return
Control voltage	DC.12V
Rated voltage	AC230V
Power frequency	50/60 Hz
Power input	2.0/2.0 A
Fuse	5A/250V(Current Rating:50A at 250VAC) Fast-blow Size of fuse 5.0 x 20mm
Weight	115Kg
Weight limit	150kg
Class of Foot Switch	IPX1 (applicable standards,IEC60529)
Applied Parts	Type B applied part : Seat for chair
Mode of Operation	Non-Continuous Operation Duration of Maximum Operating Time : 3min, Duty 1:5
Usage environment	Temperature 0 ~ 40°C Humidity 10 ~ 95% (No condensation) Air pressure 700 ~ 1060 hPa
Transportation / Storage environment	Temperature -20 ~ 70°C Humidity 10 ~ 95% (No condensation) Air pressure 700 ~ 1060 hPa

Refer to the rating plate for the capacity of power supply.

The specification is subject to change without notice.

4 Specifications and Operation

4-2-2 Dimensions

[Standard Base]

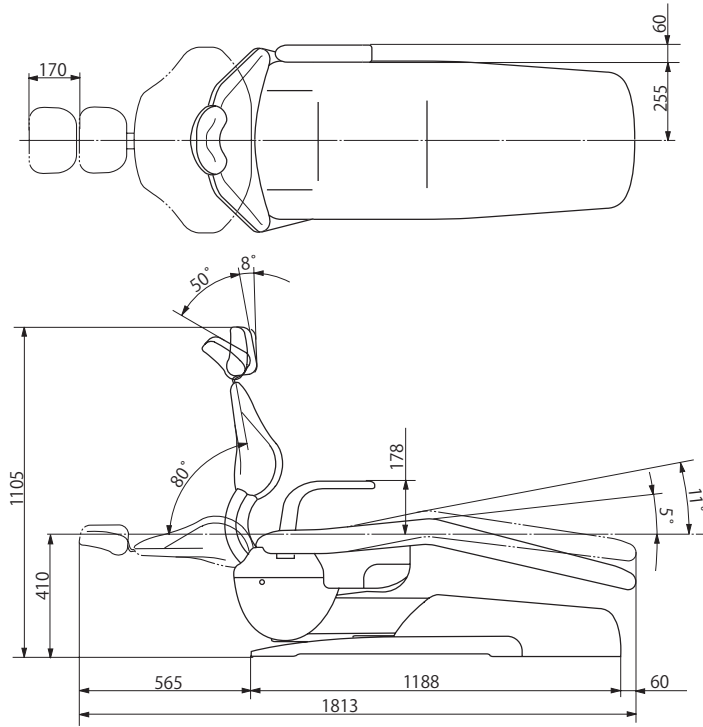

Unit: mm
Tolerance in dimensions: $\pm 10\%$

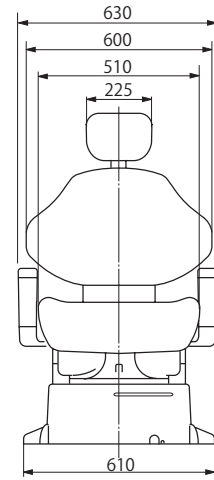

[Compact Base]

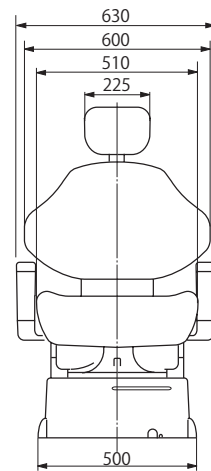
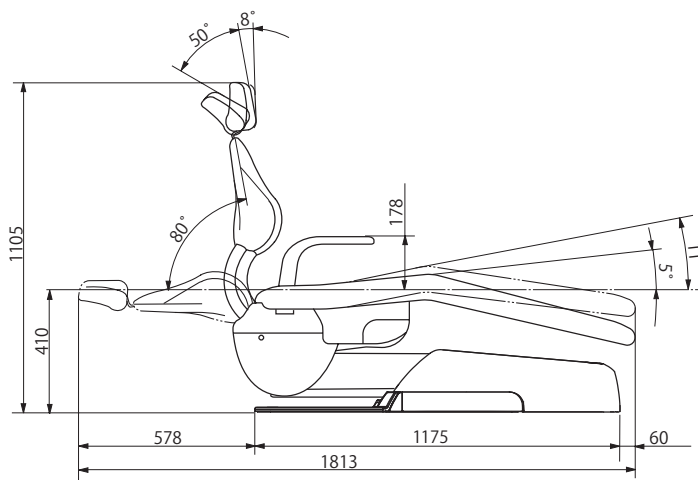

The specification is subject to change without notice.

4 Specifications and Operation

4-2-3 Name of Each Part

[Standard Base]

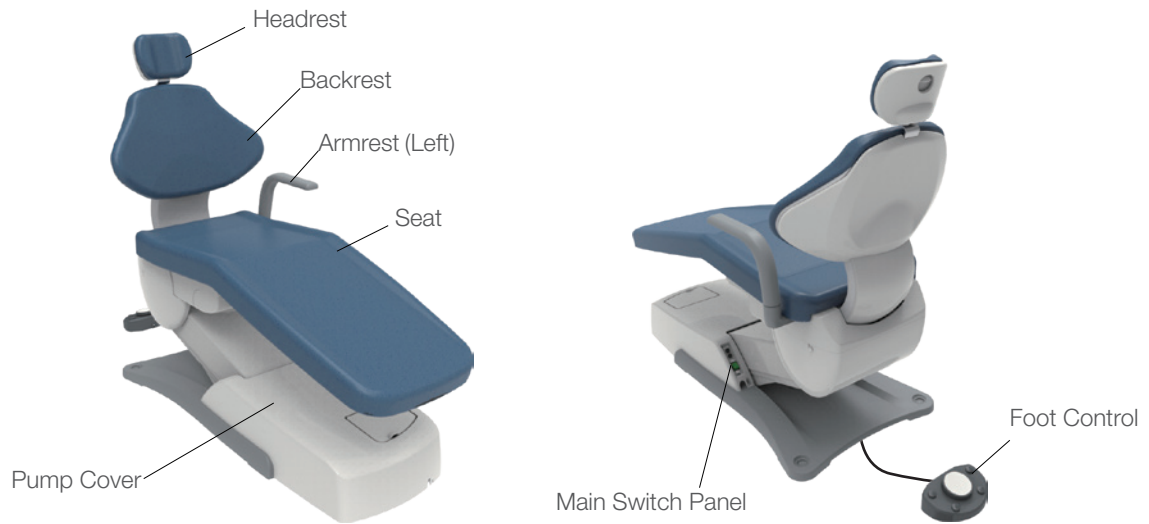

[Compact Base]

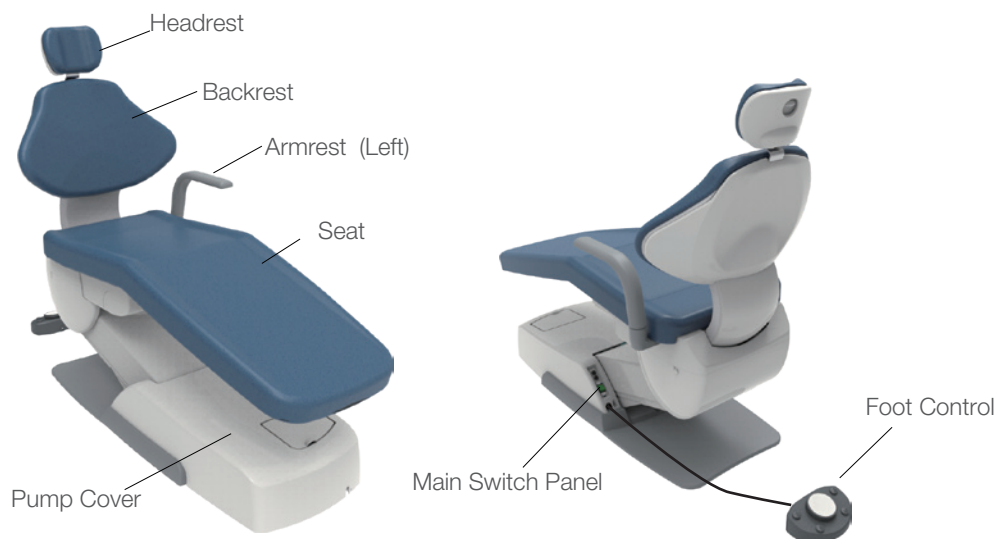

4 Specifications and Operation

4-2-4 Operation

4-2-4-1 Preparation Before Use

Turn on the power for chair

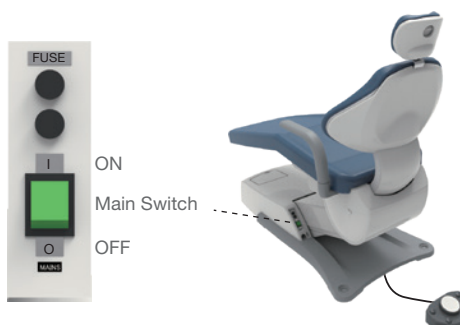

CAUTION

Operate the main switch for chair by hand.

4-2-4-2 After use

Turn off the power for chair

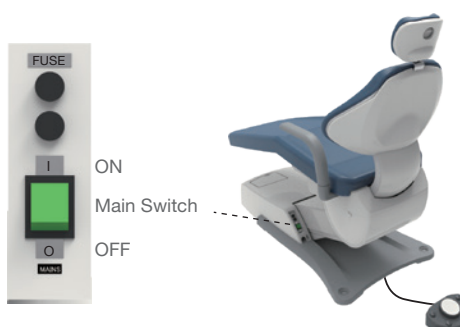

CAUTION

Operate the main switch for chair by hand.

4 Specifications and Operation

4-2-4-3 Raising/lowering the chair and raising/reclining the backrest (manual operation)

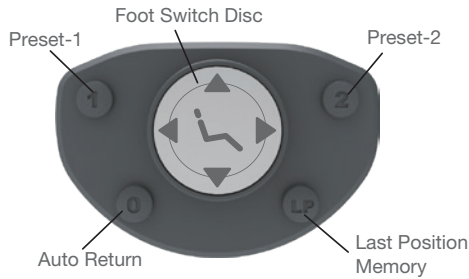

Switch	Operation

*The chair is operated while the switch is pushed down or the switch is pressed.

WARNING

Before raising/lowering the chair, ensure that the chair does not contact any body parts, hands, feet, or objects.

Before reclining the backrest, confirm that the patient's arm or hand is not placed between the backrest and the seat.

Before raising the backrest, confirm that the patient's arm or hand is not placed between the backrest and the armrest.

[Reference] Precautions when a patient is seated

4 Specifications and Operation

4-2-4-4 Moving the chair to the preset position (automatic operation)

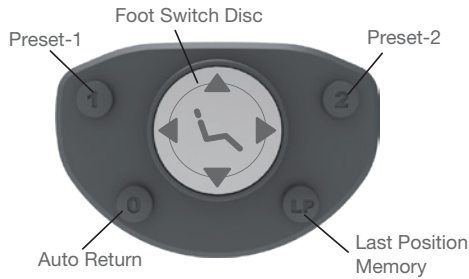

Switch	Operation
	"Treatment position 1".
	"Treatment position 2".
	"Entry/exit position".
	"Mouth rinsing position".
	"Previous position".

Do not press the stick switch for automatic operation for five seconds or longer. If pressed for five seconds or more, a buzzer sound is heard, and the chair position at that point is memorized as a preset position.
[Reference] Automatic operation setting

WARNING

Before moving the chair, confirm that no human body part, limb, or obstacle is obstructing the chair.

4-2-4-5 Headrest

Adjustment of the headrest

The headrest is capable of flexibly adjusting the inclination of the patient's head for treatment in the upper/lower jaw. It is also possible to manually extend/fold the headrest in accordance with the patient's height.

Angle adjustment of the headrest

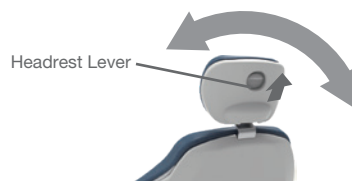

Up/down adjustment of the headrest



4-2-4-6 Double Articulating Headrest (Optional)

Angle adjustment of the headrest

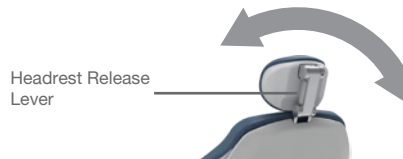

Up/down adjustment of the headrest



Do not apply excessive load or impact to the headrest while it is extended. Do not hit the headrest from above. Otherwise, failure may result.

WARNING

If the chair is to be moved with the backrest reclined while the headrest is extended, confirm that there is no object obstructing or coming into contact with the chair. This may cause damage or injury.

When operating the headrest, be careful not to get the operator's hand or finger caught around the control lever or between the headrest and the backrest.

When adjusting the angle or up/down, be sure to apply the operator's hand to the headrest and support the patient's head. Otherwise, an accident or injury may result.

4 Specifications and Operation

4-2-4-7 Turning the armrest

If the armrest hinders entry/exit or diagnosis, it may be turned backward.

Only the right armrest can be turned.



CAUTION

When turning the armrest, confirm that there is no obstruction. Operator must be careful not to get their hand or finger caught.

Do not move the chair while the armrest has been turned backward. Return the armrest to the normal position before moving the chair.

4-2-4-8 Cancellation function

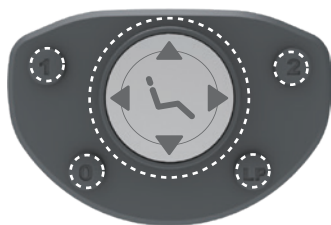

To stop the chair movement started by a switch for automatic operation (preset switch, automatic return switch, last position switch, or stick switch for automatic operation), perform one of the following operations.

Operate one of the switches (indicated with O).

4-2-4-9 Safety Look Device

When the lock function is activated, the chair movement is stopped. The functions that become locked and the unlocking steps are as follows.

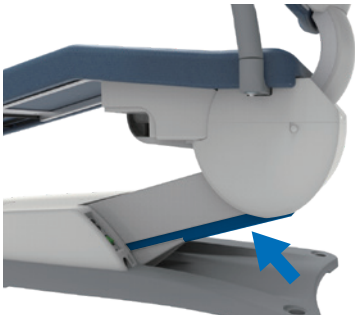
Condition	How to unlock
<p>During the chair movement, force is applied to the rear link cover in the direction indicated with an arrow</p> 	<p>Remove the obstacle that has caused emergency stop, confirm safety, and operate the chair.</p> <hr/> <p style="text-align: center;">Locked functions</p> <p>Automatic operation of the chair Manual operation (lowering, reclining the backrest)</p>

4 Specifications and Operation

4-2-4-10 Auto Mode Position Adjustment

(1) Preset position Adjustment

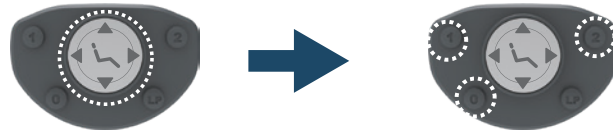
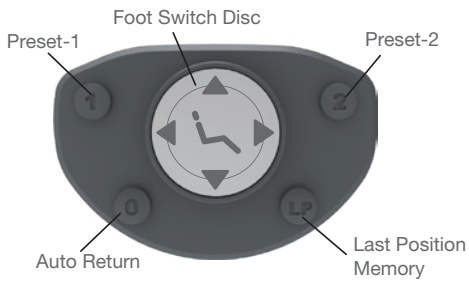

Set the treatment position by chair manual switch

Keep pressing 5seconds.
1,2: Chair preset position
0:Auto return position

(2) Mouth Rinsing Position Adjustment

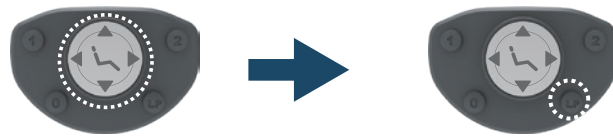

Move the chair to rinsing position by chair manual switch

Keep pressing 5seconds.
LP: Last position

4 Specifications and Operation

4-3 CLESTA eIII CHAIR

4-3-1 Specifications

Model	AC-CL3-C230* (* represents single or multiple strings or numbers.)
Seat height	400 ~ 780 mm (Electro-hydraulic system)
Seat lifting stroke	380 mm
Backrest movement	0° ~ 73° (Electro-hydraulic system)
Classification for protection against electric shock	Class I Equipment
Tilting mechanism	10° ~ 18° (Backrest Synchronized Tilting)
Headrest stroke	170 mm (Manual operation)
Headrest moving angle	58° (Manual operation)
Auto movements	Last position x 1, Auto return x 1, Preset position x 2
Rated voltage	AC230V
Power frequency	50/60 Hz
Power input	2.2/2.2 A
Fuse	5A/250V(Current Rating:50A at 250VAC) Fast blow Size of fuse 5.0 x 20mm
Weight	140kg
Weight limit	150kg
Mode of operation	Non-Continuous Operation Duration of Maximum Operating Time: 3min Duty Cycle 1 : 5
Classification of foot controller	IPX1 (applicable standard IEC60529)
Applied part	type B applied part: Seat for chair
Usage environment	Temperature 0 ~ 40°C Humidity 10 ~ 95% (No condensation) Air pressure 700 ~ 1060 hPa
Transportation / Storage environment	Temperature -20 ~ 70°C Humidity 10 ~ 95% (No condensation) Air pressure 700 ~ 1060 hPa

Refer to the rating plate for the capacity of power supply.

The specification is subject to change without notice.

4 Specifications and Operation

4-3-2 Dimensions

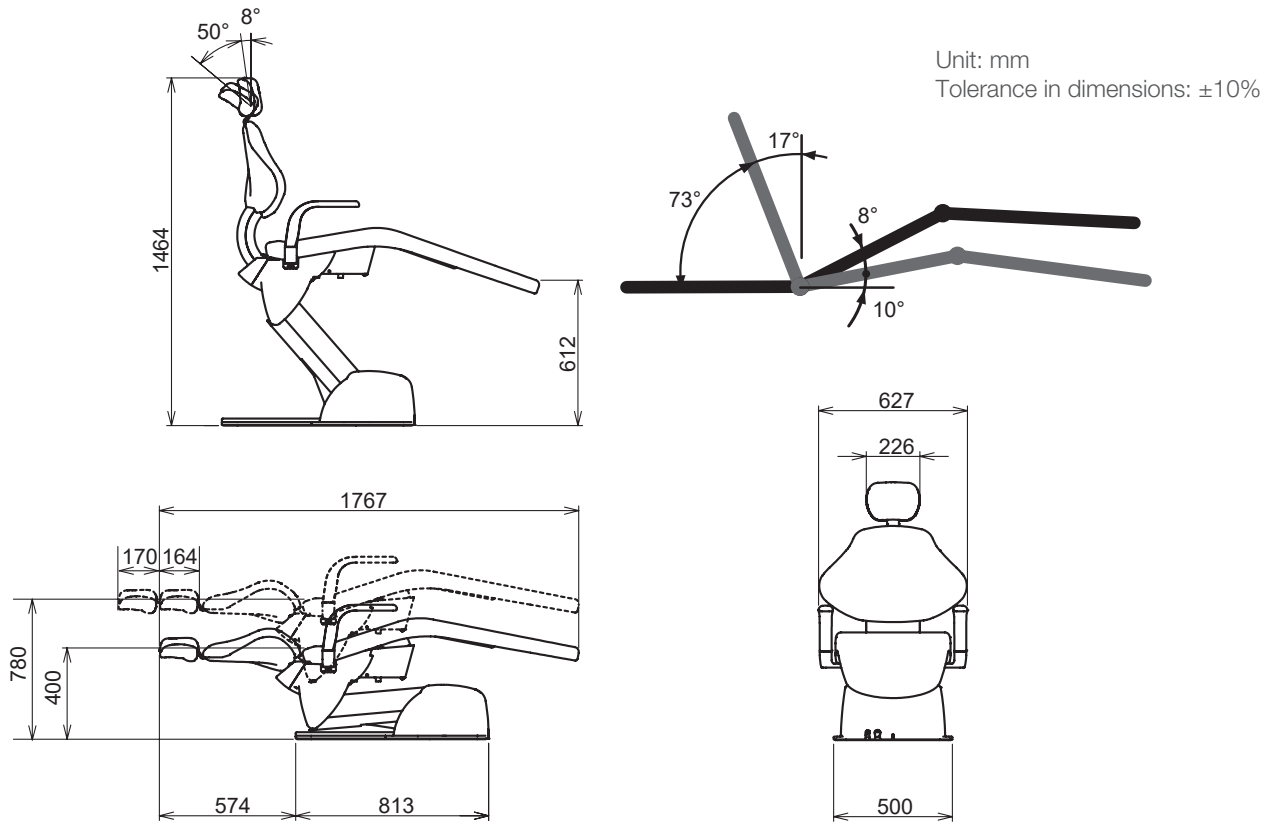

The specification is subject to change without notice.

4-3-3 Name of Each Part

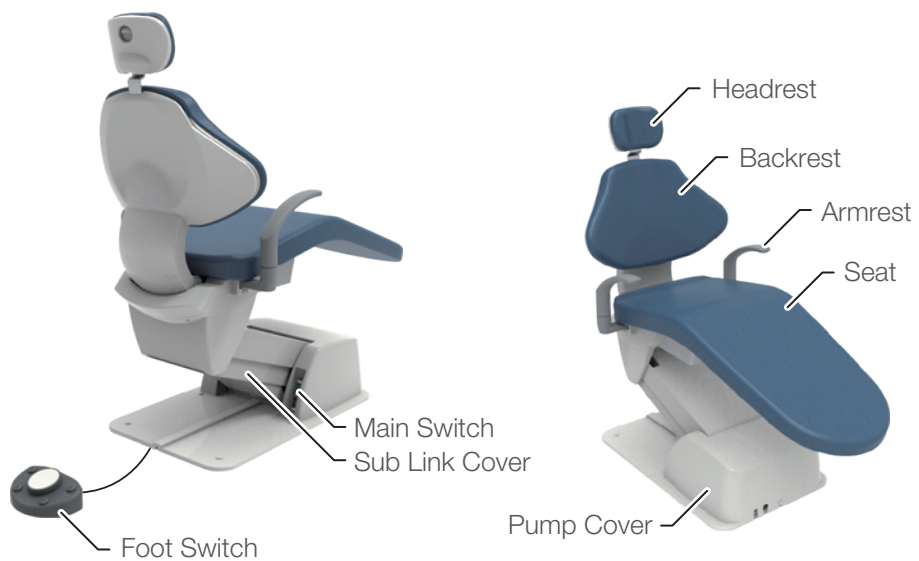

4 Specifications and Operation

4-3-4 Operation

4-3-4-1 Preparation Before Use

Turn on the power for chair

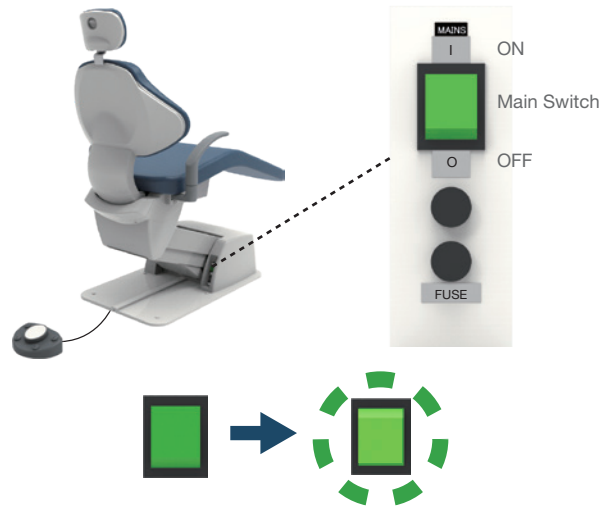

CAUTION

Operate the main switch for chair by hand.

4-3-4-2 After use

Turn off the power for chair

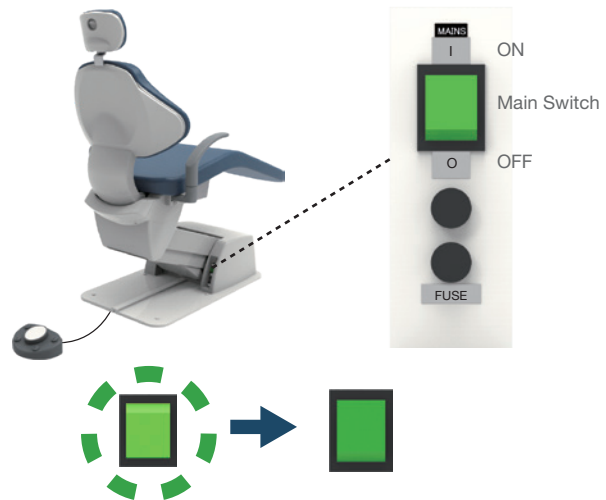

CAUTION

Operate the main switch for chair by hand.

4 Specifications and Operation

4-3-4-3 Raising/lowering the chair and raising/reclining the backrest (manual operation)

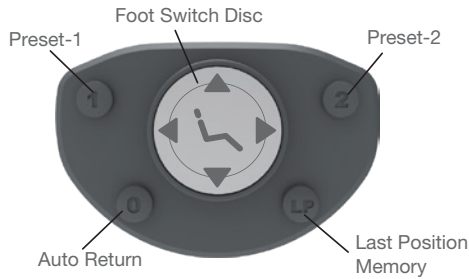

Switch	Operation

*The chair is operated while the switch is pushed down or the switch is pressed.

WARNING

Before raising/lowering the chair, ensure that the chair does not contact any body parts, hands, feet, or objects.

Before reclining the backrest, confirm that the patient's arm or hand is not placed between the backrest and the seat.

Before raising the backrest, confirm that the patient's arm or hand is not placed between the backrest and the armrest.

[Reference] Precautions when a patient is seated

4 Specifications and Operation

4-3-4-4 Moving the chair to the preset position (automatic operation)

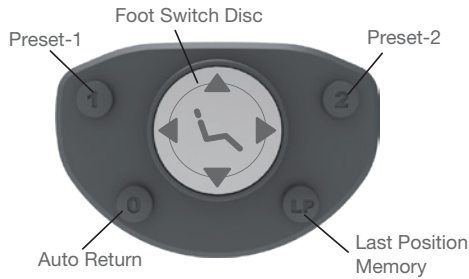

Switch	Operation
	"Treatment position 1".
	"Treatment position 2".
	"Entry/exit position".
	"Mouth rinsing position". "Previous position".

Do not press the stick switch for automatic operation for five seconds or longer. If pressed for five seconds or more, a buzzer sound is heard, and the chair position at that point is memorized as a preset position.

[Reference] Automatic operation setting

WARNING

Before moving the chair, confirm that no human body part, limb, or obstacle is obstructing the chair.

4-3-4-5 Headrest

Adjustment of the headrest

The headrest is capable of flexibly adjusting the inclination of the patient's head for treatment in the upper/lower jaw. It is also possible to manually extend/fold the headrest in accordance with the patient's height.

Angle adjustment of the headrest

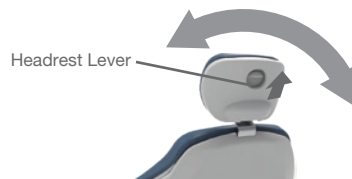

Up/down adjustment of the headrest



4-3-4-6 Double Articulating Headrest (Optional)

Angle adjustment of the headrest

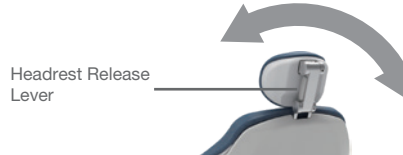

Up/down adjustment of the headrest



Do not apply excessive load or impact to the headrest while it is extended. Do not hit the headrest from above. Otherwise, failure may result.

WARNING

If the chair is to be moved with the backrest reclined while the headrest is extended, confirm that there is no object obstructing or coming into contact with the chair. This may cause damage or injury.

When operating the headrest, be careful not to get the operator's hand or finger caught around the control lever or between the headrest and the backrest.

When adjusting the angle or up/down, be sure to apply the operator's hand to the headrest and support the patient's head. Otherwise, an accident or injury may result.

4 Specifications and Operation

4-3-4-7 Turning the armrest

If the armrest hinders entry/exit or diagnosis, it may be turned backward.

Only the right armrest can be turned.



CAUTION

When turning the armrest, confirm that there is no obstruction. Operator must be careful not to get their hand or finger caught.

Do not move the chair while the armrest has been turned backward. Return the armrest to the normal position before moving the chair.

4-3-4-8 Cancellation function

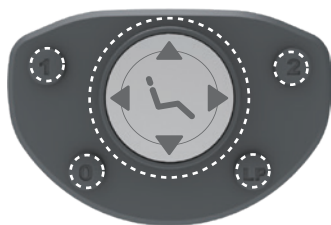

To stop the chair movement started by a switch for automatic operation (preset switch, automatic return switch, last position switch, or stick switch for automatic operation), perform one of the following operations.

Operate one of the switches (indicated with O).

4-3-4-9 Safety Look Device

When the lock function is activated, the chair movement is stopped. The functions that become locked and the unlocking steps are as follows.

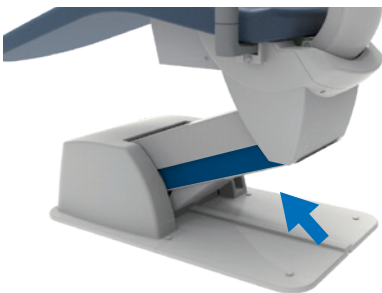
Condition	How to unlock
<p data-bbox="92 1736 699 1836">During the chair movement, force is applied to the rear link cover in the direction indicated with an arrow</p> 	<p data-bbox="766 1736 1476 1803">Remove the obstacle that has caused emergency stop, confirm safety, and operate the chair.</p> <hr/> <p data-bbox="1013 1937 1252 1982" style="text-align: center;">Locked functions</p> <p data-bbox="766 2004 1412 2072">Automatic operation of the chair Manual operation (lowering, reclining the backrest)</p>

4 Specifications and Operation

4-3-4-10 Auto Mode Position Adjustment

(1) Preset position Adjustment

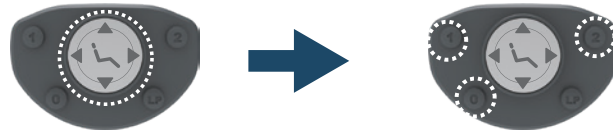
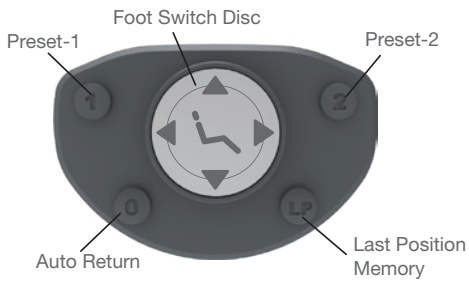

Set the treatment position by chair manual switch

Keep pressing 5seconds.
1,2: Chair preset position
0:Auto return position

(2) Mouth Rinsing Position Adjustment

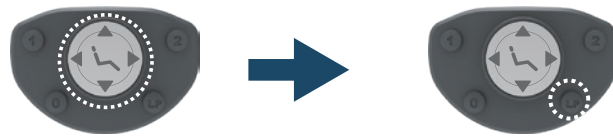

Move the chair to rinsing position by chair manual switch

Keep pressing 5seconds.
LP: Last position

4 Specifications and Operation

4-4 CLESTA eIII CHAIR (SWING TYPE)

4-4-1 Specifications

Model	AC-E3S-CD* (* represents single or multiple strings or numbers.)
Seat height	490 ~ 800 mm (Electro-hydraulic system)
Seat lifting stroke	310 mm
Backrest movement	0° ~ 73° (Electro-hydraulic system)
Classification for protection against electric shock	Class I Equipment
Tilting mechanism	8° ~ 18° (Backrest Synchronized Tilting)
Headrest stroke	170 mm (Manual operation)
Headrest moving angle	58° (Manual operation)
Auto movements	Last position x 1, Auto return x 1, Preset position x 2
Rated voltage	AC230V
Power frequency	50/60 Hz
Power input	2.0/2.0 A
Fuse	5A/250V(Current Rating:50A at 250VAC) Fast blow Size of fuse 5.0 x 20mm
Weight	151.5kg
Weight limit	200kg
Mode of operation	Non-Continuous Operation Duration of Maximum Operating Time: 3min Duty Cycle 1 : 5
Classification of foot controller	IPX1 (applicable standard IEC60529)
Applied part	type B applied part: Seat for chair
Usage environment	Temperature 0 ~ 40°C Humidity 10 ~ 95% (No condensation) Air pressure 700 ~ 1060 hPa
Transportation / Storage environment	Temperature -20 ~ 70°C Humidity 10 ~ 95% (No condensation) Air pressure 700 ~ 1060 hPa

Refer to the rating plate for the capacity of power supply.

The specification is subject to change without notice.

4 Specifications and Operation

4-4-2 Dimensions

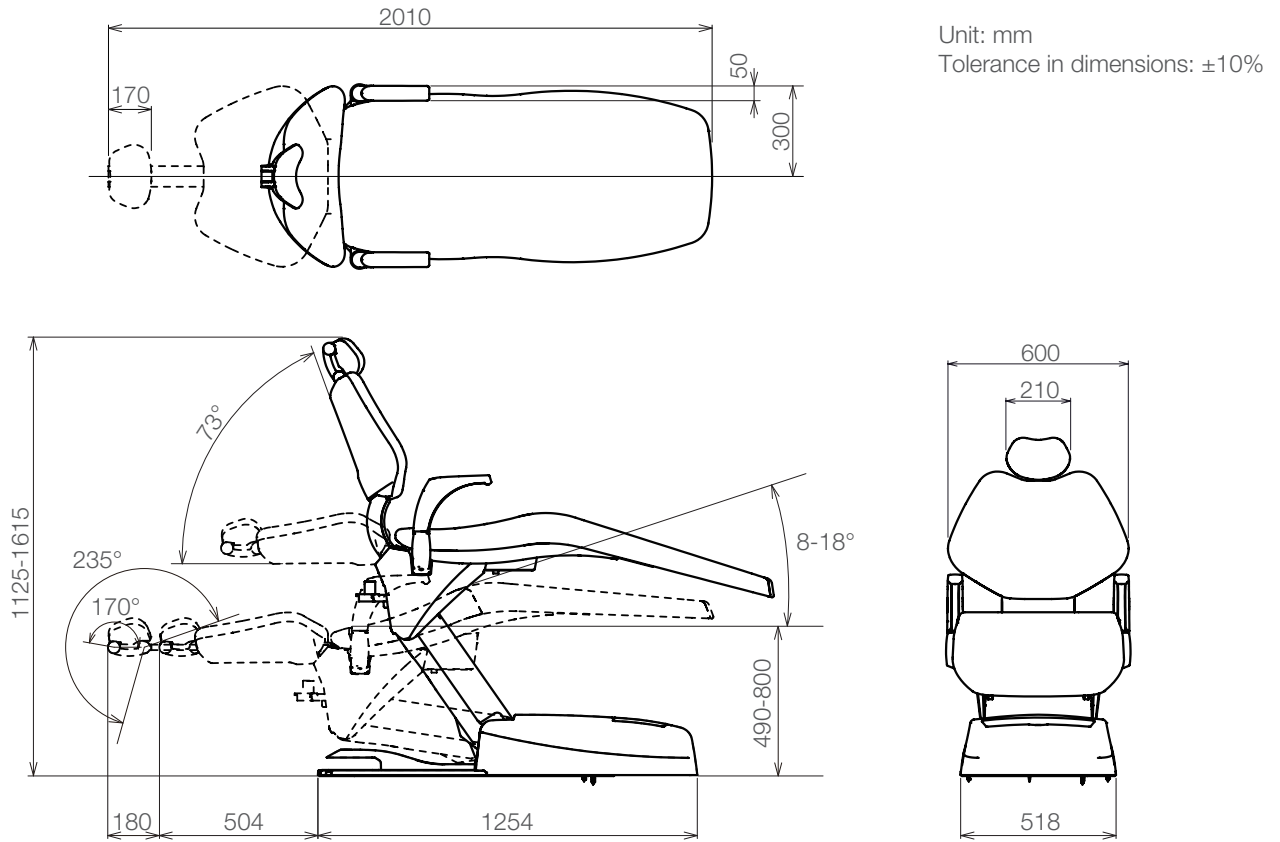

The specification is subject to change without notice.

4-4-3 Name of Each Part

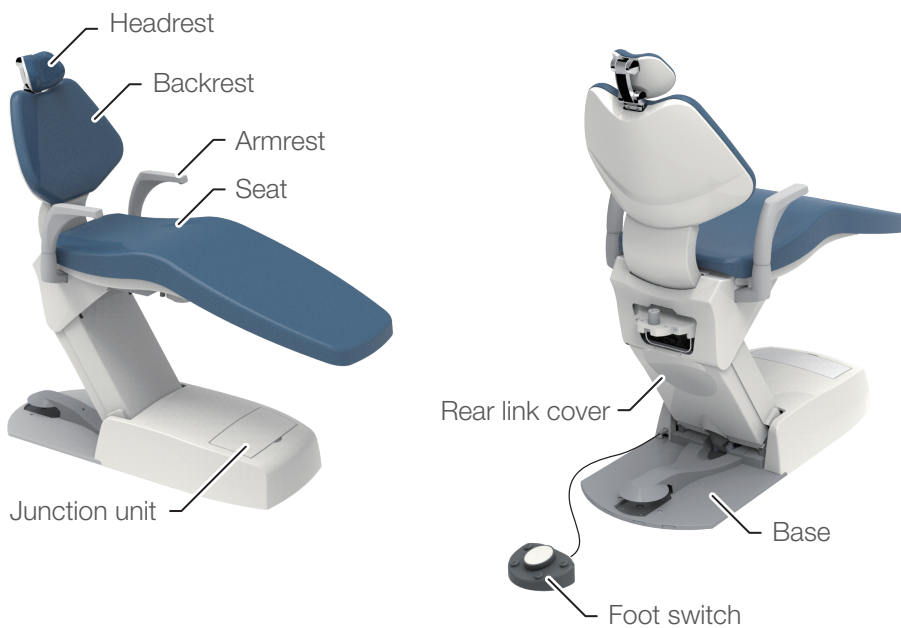

4 Specifications and Operation

4-4-4 Operation

4-4-4-1 Preparation Before Use

Turn on the power for chair

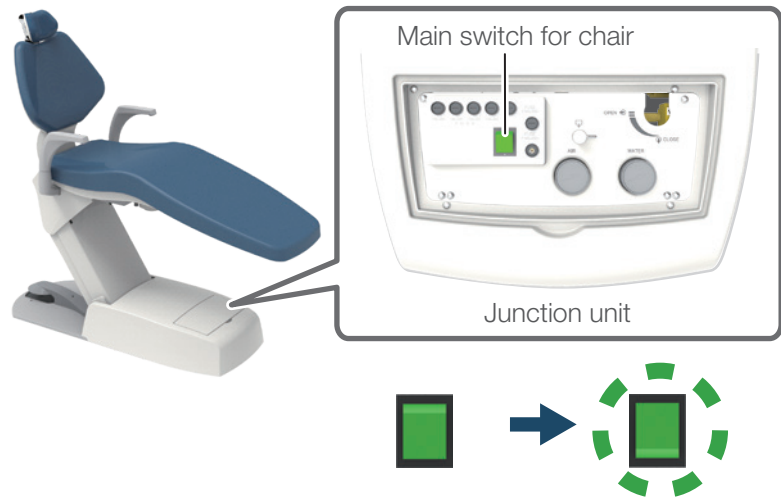

CAUTION

Operate the main switch for chair by hand.

4-4-4-2 After use

Turn off the power for chair

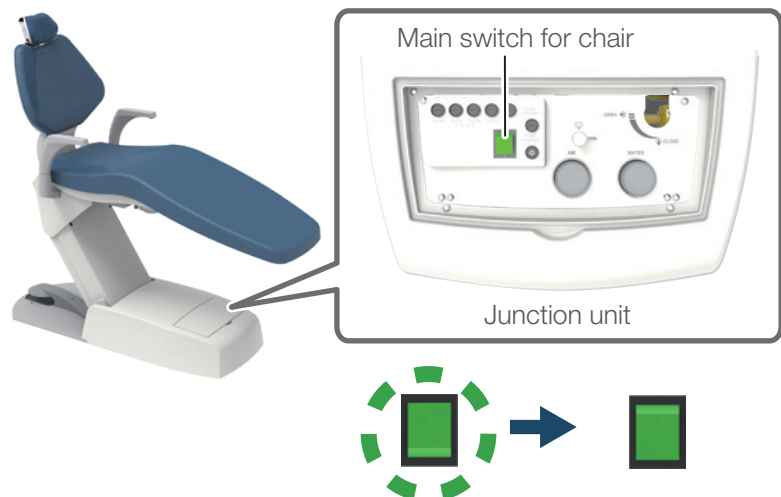

CAUTION

Operate the main switch for chair by hand.

4 Specifications and Operation

4-4-4-3 Raising/lowering the chair and raising/reclining the backrest (manual operation)

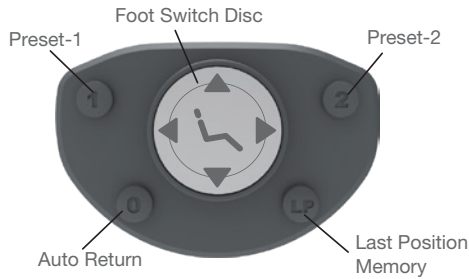

Switch	Operation

*The chair is operated while the switch is pushed down or the switch is pressed.

WARNING

Before raising/lowering the chair, ensure that the chair does not contact any body parts, hands, feet, or objects.

Before reclining the backrest, confirm that the patient's arm or hand is not placed between the backrest and the seat.

Before raising the backrest, confirm that the patient's arm or hand is not placed between the backrest and the armrest.

[Reference] Precautions when a patient is seated

4 Specifications and Operation

4-4-4-4 Moving the chair to the preset position (automatic operation)

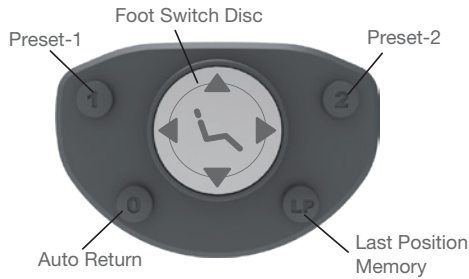

Switch	Operation
	"Treatment position 1".
	"Treatment position 2".
	"Entry/exit position".
	"Mouth rinsing position".
	"Previous position".

Do not press the stick switch for automatic operation for five seconds or longer. If pressed for five seconds or more, a buzzer sound is heard, and the chair position at that point is memorized as a preset position.
[Reference] Automatic operation setting

WARNING

Before moving the chair, confirm that no human body part, limb, or obstacle is obstructing the chair.

4-4-4-5 Headrest

Adjustment of the headrest

The headrest is capable of flexibly adjusting the inclination of the patient's head for treatment in the upper/lower jaw. It is also possible to manually extend/fold the headrest in accordance with the patient's height.

Angle adjustment of the headrest

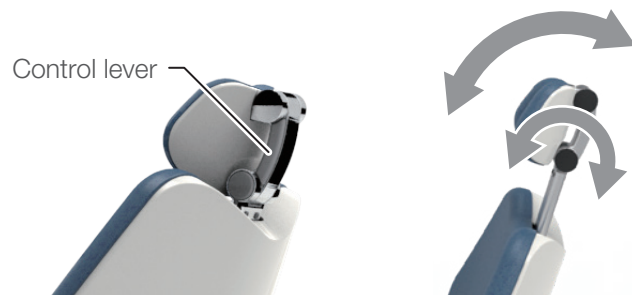

Up/down adjustment of the headrest

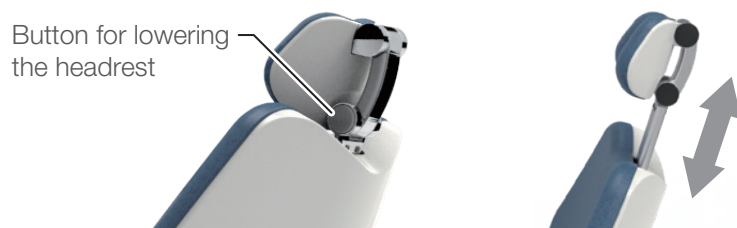

Do not apply excessive load or impact to the headrest while it is extended. Do not hit the headrest from above. Otherwise, failure may result.

WARNING

If the chair is to be moved with the backrest reclined while the headrest is extended, confirm that there is no object obstructing or coming into contact with the chair. This may cause damage or injury.

When operating the headrest, be careful not to get the operator's hand or finger caught around the control lever or between the headrest and the backrest.

When adjusting the angle or up/down, be sure to apply the operator's hand to the headrest and support the patient's head. Otherwise, an accident or injury may result.

4 Specifications and Operation

4-4-4-6 Turning the armrest

If the armrest hinders entry/exit or diagnosis, it may be turned backward.

Both the left and right armrests can be turned.



CAUTION

When turning the armrest, confirm that there is no obstruction. Operator must be careful not to get their hand or finger caught.

Do not move the chair while the armrest has been turned backward. Return the armrest to the normal position before moving the chair.

4-4-4-7 Cancellation function

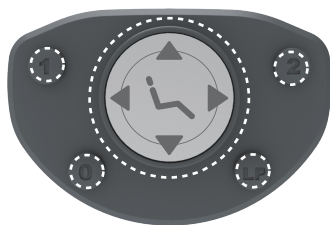

To stop the chair movement started by a switch for automatic operation (preset switch, automatic return switch, last position switch, or stick switch for automatic operation), perform one of the following operations.

Operate one of the switches (indicated with ○).

4-4-4-8 Safety Look Device

When the lock function is activated, the chair movement is stopped. The functions that become locked and the unlocking steps are as follows.

Condition	How to unlock
<p>During the chair movement, force is applied to the rear link cover in the direction indicated with an arrow</p> 	<p>Remove the obstacle that has caused emergency stop, confirm safety, and operate the chair.</p> <hr/> <p style="text-align: center;">Locked functions</p> <p>Automatic operation of the chair Manual operation (lowering, reclining the backrest)</p>

4 Specifications and Operation

4-4-4-9 Auto Mode Position Adjustment

(1) Preset position Adjustment

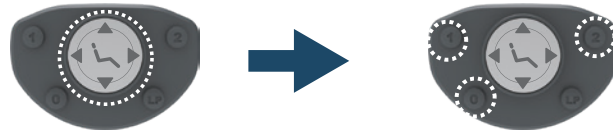
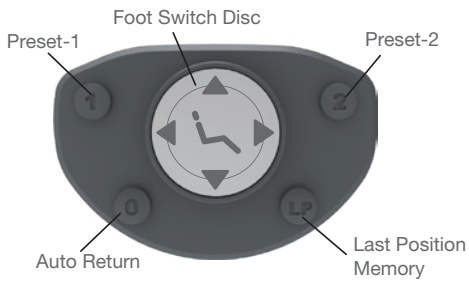

Set the treatment position by chair manual switch

Keep pressing 5seconds.
1,2: Chair preset position
0:Auto return position

(2) Mouth Rinsing Position Adjustment



Move the chair to rinsing position by chair manual switch

Keep pressing 5seconds.
LP: Last position



4 Specifications and Operation

4-5 PROGRES

4-5-1 Specifications

Model	AC-PRO-230V* (* represents single or multiple strings or numbers.)
Seat Initial Height	420mm
Seat Lifting Stroke	400mm
Backrest Movement	-2° ~ 70° above Horizontal
Classification for protection against electric shock	Class I Equipment
Auto Movements	2 Preset, 1Last Position Memory and 1 Auto Return
Control Voltage	DC12V
Rated voltage	AC230V
Power frequency	50/60 Hz
Power input	2.0/2.0 A
Fuse	5A/250V (Current Rating:50A at 250VAC) Fast-blow
Weight	160kg
Weight limit	150kg
Class of Foot Switch	IPX1 (applicable standars, IEC60529)
Applied Parts	Type B applied part : Seat for chair
Mode of Operation	Non-Continuous Operation Duration of Maximum Operating Time :3min, Duty 1:5
Usage environment	Temperature 0 ~ 40°C Humidity 10 ~ 95% (No condensation) Air pressure 700 ~ 1060 hPa
Transportation / Storage environment	Temperature -20 ~ 70°C Humidity 10 ~ 95% (No condensation) Air pressure 700 ~ 1060 hPa

Refer to the rating plate for the capacity of power supply.

The specification is subject to change without notice.

4 Specifications and Operation

4-5-2 Dimensions

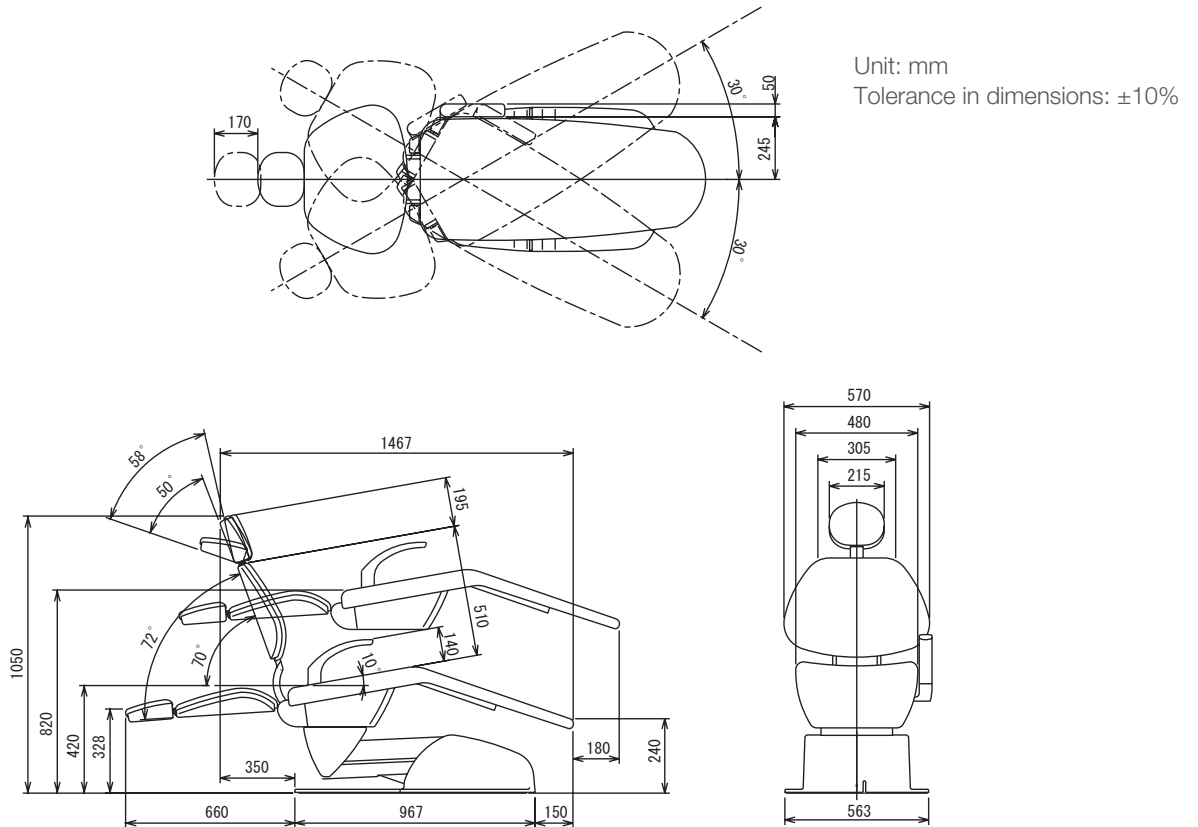

The specification is subject to change without notice.

4-5-3 Name of Each Part

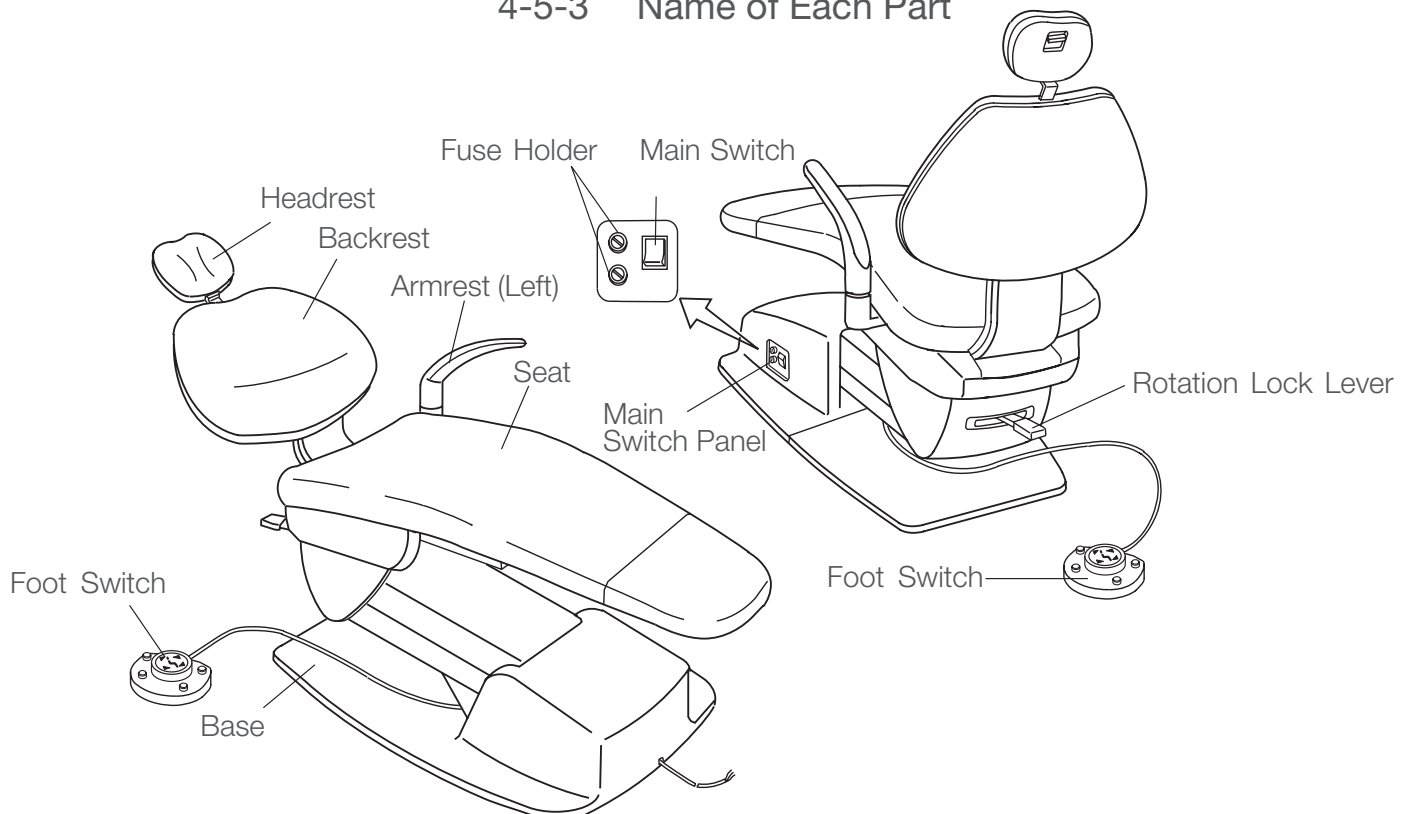

4 Specifications and Operation

4-5-4 Operation

4-5-4-1 Preparation Before Use

Turn on the power for chair

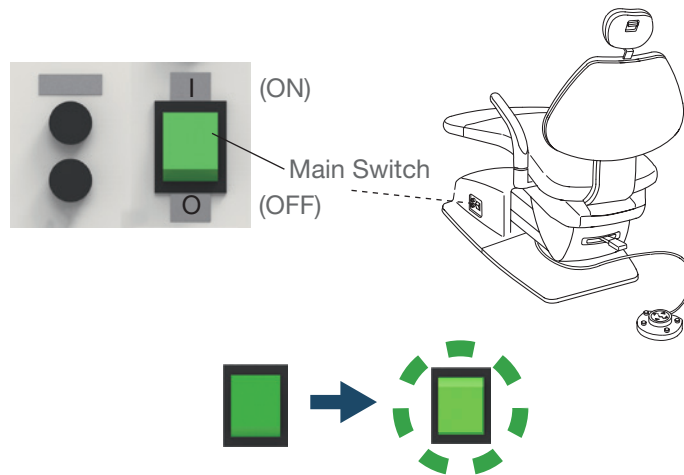

CAUTION

Operate the main switch for chair by hand.

4-5-4-2 After use

Turn off the power for chair

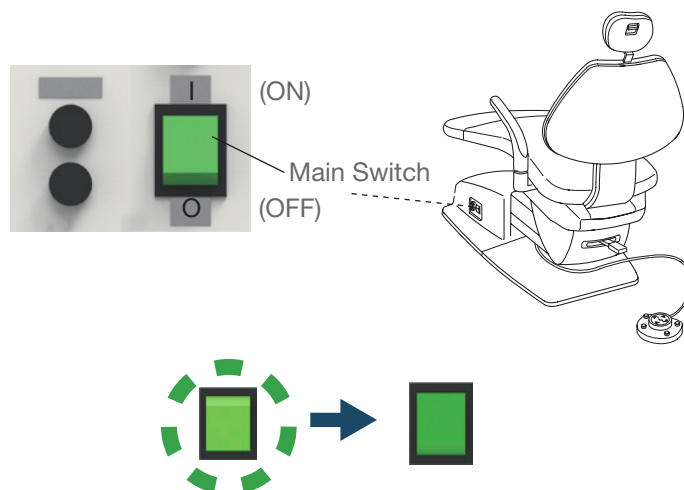

CAUTION

Operate the main switch for chair by hand.

4 Specifications and Operation

4-5-4-3 Raising/lowering the chair and raising/reclining the backrest (manual operation)

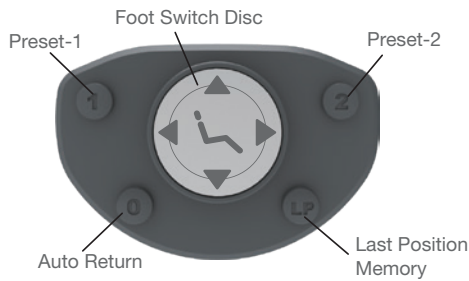

Switch	Operation

*The chair is operated while the switch is pushed down or the switch is pressed.

WARNING

Before raising/lowering the chair, ensure that the chair does not contact any body parts, hands, feet, or objects.

Before reclining the backrest, confirm that the patient's arm or hand is not placed between the backrest and the seat.

Before raising the backrest, confirm that the patient's arm or hand is not placed between the backrest and the armrest.

[Reference] Precautions when a patient is seated

4 Specifications and Operation

4-5-4-4 Moving the chair to the preset position (automatic operation)

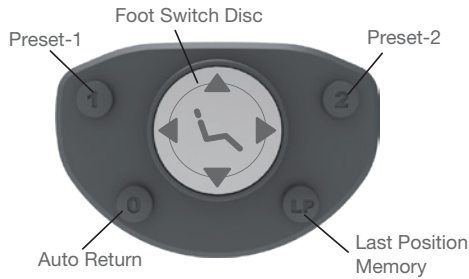

Switch	Operation
	"Treatment position 1".
	"Treatment position 2".
	"Entry/exit position".
	"Mouth rinsing position".
	"Previous position".

Do not press the stick switch for automatic operation for five seconds or longer. If pressed for five seconds or more, a buzzer sound is heard, and the chair position at that point is memorized as a preset position.

[Reference] Automatic operation setting

WARNING

Before moving the chair, confirm that no human body part, limb, or obstacle is obstructing the chair.

4-5-4-5 Headrest

Adjustment of the headrest

The headrest is capable of flexibly adjusting the inclination of the patient's head for treatment in the upper/lower jaw. It is also possible to manually extend/fold the headrest in accordance with the patient's height.

Angle adjustment of the headrest

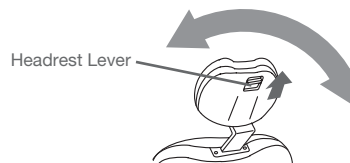

Up/down adjustment of the headrest

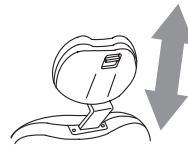

Do not apply excessive load or impact to the headrest while it is extended. Do not hit the headrest from above. Otherwise, failure may result.



WARNING

If the chair is to be moved with the backrest reclined while the headrest is extended, confirm that there is no object obstructing or coming into contact with the chair. This may cause damage or injury.

When operating the headrest, be careful not to get the operator's hand or finger caught around the control lever or between the headrest and the backrest.

When adjusting the angle or up/down, be sure to apply the operator's hand to the headrest and support the patient's head. Otherwise, an accident or injury may result.

4 Specifications and Operation

4-5-4-6 Chair Rotation

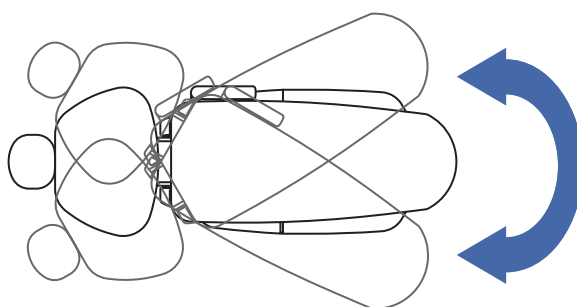
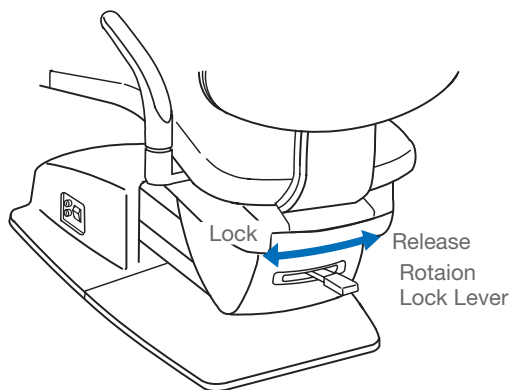

4-5-4-7 Cancellation function

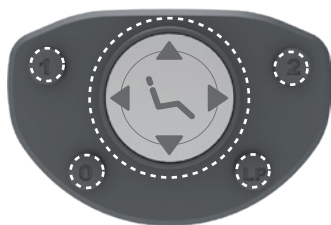

To stop the chair movement started by a switch for automatic operation (preset switch, automatic return switch, last position switch, or stick switch for automatic operation), perform one of the following operations.

Operate one of the switches (indicated with ○).

4-5-4-8 Safety Lock Device

When the lock function is activated, the chair movement is stopped. The functions that become locked and the unlocking steps are as follows.

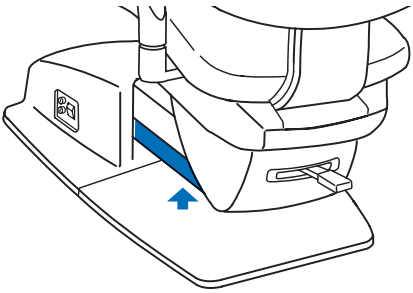
Condition	How to unlock
<p data-bbox="92 1742 730 1841">During the chair movement, force is applied to the rear link cover in the direction indicated with an arrow</p> 	<p data-bbox="769 1742 1471 1809">Remove the obstacle that has caused emergency stop, confirm safety, and operate the chair.</p> <hr/> <p data-bbox="1008 1944 1248 1975" style="text-align: center;">Locked functions</p> <p data-bbox="769 1998 1407 2078">Automatic operation of the chair Manual operation (lowering, reclining the backrest)</p>

4 Specifications and Operation

4-5-4-9 Auto Mode Position Adjustment

(1) Preset position Adjustment

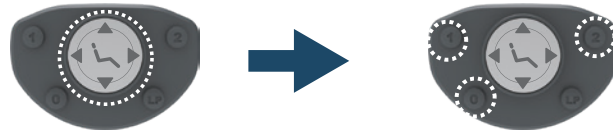
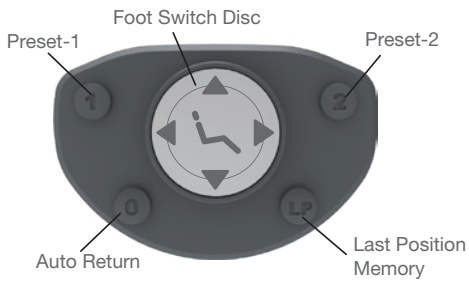

Set the treatment position by chair manual switch

Keep pressing 5seconds.
1,2: Chair preset position
0:Auto return position

(2) Mouth Rinsing Position Adjustment

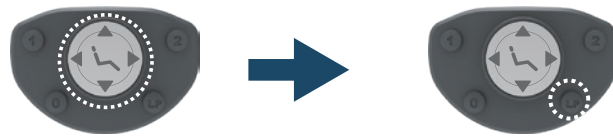

Move the chair to rinsing position by chair manual switch

Keep pressing 5seconds.
LP: Last position

5 Maintenance and Cleaning

5-1 Exterior

5-1-1 Cleaning and disinfecting the surfaces

To clean and disinfect the exterior of the product, wipe the surface with a soft cloth or paper towel moistened with FD366 manufactured by Dürr, and then wipe it with a dry cloth.

If the exterior is excessively dirty, moisten a soft cloth with water containing approx 10% of neutral detergent, and wipe the exterior with the cloth. Then, wipe it with a cloth moistened with water and dry it completely with a dry cloth.

Never use any of the products listed below:

Volatile chemicals such as paint thinner, butanol, isopropyl alcohol, nail-varnish remover, gasoline, or kerosene; acid, alkaline or chlorine detergents; highly corrosive disinfectants (povidone-iodine such as Isodine, sodium hypochlorite, etc.); abrasive polishing wax or abrasive sponge

Do not use a brush or scrubber for maintenance. All of these may leave scratches and/or ingrained dirt.

If water or detergent is left on the surface, wipe it off immediately. Moisture or detergent may cause rust or failure of electrical parts.

Do not spray detergent directly onto the exterior.

Clean the surface with a soft cloth or paper towel moistened with detergent, and wipe it dry with a cloth.

If liquid enters the product, it may cause a malfunction or failure.

Confirm that the detergent has completely dried off before activating the product.

5 Maintenance and Cleaning

5-2 Leather part

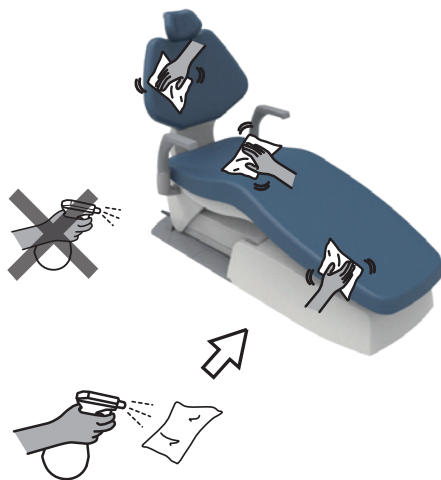

Wipe the surface with a soft cloth or paper towel moistened with FD360 manufactured by Dürr, and then wipe it with a dry cloth.

If it is excessively dirty, moisten a soft cloth with water containing approx. 10% neutral detergent, and wipe it with the cloth. Then, wipe it with a cloth moistened with water and then dry it completely with a dry cloth.

[Reference] Precautions for Using Synthetic Leathers

Do not use organic solvents, detergents containing abrasives, or bleach to clean the leather part.
All of these may deteriorate the surface and change texture or gloss.

Do not spray detergent directly onto the leather part or exterior.
Clean the surface with a soft cloth or paper towel moistened with detergent, and wipe it with a dry cloth.

The liquid may enter the product through gaps and cause a malfunction or failure.

Confirm that the detergent has completely dried off before activating the product.

5 Maintenance and Cleaning

5-3 Maintenance and inspection

5-3-1 Notes on daily maintenance and inspection (by the user)

It is the responsibility of the user (medical institution) to ensure that the medical device is correctly maintained and inspected. To ensure safe use of this product, the product must be inspected at the specified intervals as described in the table below:

No	Inspection item	Inspection interval	Inspection procedure and criteria	Outcome if inspection is not conducted	Maintenance required when the inspection criterion is not satisfied
1	Check the cancel function	Before consulting hours	When the chair is in automatic operation, it must stop when any of the stick switches is pressed.	The chair unexpectedly moves during procedure, resulting in an injury. The patients may be caught between the doctor unit and the chair, resulting in an accident.	If the chair does not stop, please contact your local authorized Belmont dealer.
2	Check for oil leaks	Before consulting hours	Check that no oil leaks out from the product.	The product does not function properly, preventing proper treatment or procedure.	If oil leaks out, please contact your local authorized Belmont dealer.
3	Maintenance Exterior	After consulting hours	Check that no chemical solution or dirty water adheres to or remains on the exterior of the product.	Any liquid remaining will causes discoloration or change the properties of the exterior or cause metal parts to rust.	Clean it.
4	Movable parts of the product	Before consulting hours	When operating the product, check that no movable parts emit any abnormal noise.	The product does not function properly, preventing proper treatment or procedure.	If any movable parts emit an abnormal noise, please contact your local authorized Belmont dealer.



WARNING

Always refer to this Instructions for Use before conducting daily maintenance and inspection.

If you do not conduct daily maintenance or inspection, use of the product may result in injury or damage to nearby devices.

5 Maintenance and Cleaning

5-3-2 Notes for periodic inspection

The product contains parts that stop functioning or wear depending on the use frequency, and therefore it is important to carry out maintenance in a periodic inspection once a year (including replacement of consumables) and safety checks.

Service parts required for the periodic inspection (including consumables) are listed in the table below. However, depending on the specifications of your device, there may be alternative parts available that differ from those listed in the table below.

Maintenance and inspection can be outsourced to qualified persons such as authorized repairers of medical devices.

If you have any question about periodic inspection, contact your local authorized Belmont dealer.

List of service parts required for the periodic inspection

Part name	Standard service life	Part name	Standard service life
Movable part	7 years	Switch	5 years
Wire for a movable part	5 years	PC board	5 years



WARNING

Always entrust periodic inspection to your local authorized Belmont dealer.

If you do not carry out periodic inspection, use of the product may cause injury or damage to nearby devices.

5-4 Storage method

If the product is not used for an extended period of time after consulting hours or during holidays, make sure you observe the precautions below:

1. Turn off the breaker for the device in the clinic. (Also make sure you have turned off the power.)
2. Set the chair to the lowest position and the backrest to the most reclined position.

6-1 After-sales service

When you request for repair

Refer to 'Troubleshooting' before you check the device. If the problem persists, turn off the main switch (or the main switch of the unit), and contact your local authorized Belmont dealer to request a repair.

6-2 Service life

The service life of this product is 10 years on condition that maintenance and inspection are properly conducted [according to our self-certification (our data)].

However, the standard service lives of service parts that require periodic inspection vary according to the part.

6-3 Period of Parts Retention

We hold service parts such as consumables for products for 10 years from the time of purchase.

* Service parts are parts required for repair to return the product to the original state and functions or to maintain its functions.

7 Troubleshooting

7-1 Troubleshooting

If you encounter any of the problems listed below, take the countermeasures described below before requesting a repair. If the problem persists even after troubleshooting, stop using the product immediately, turn off the main switch (or the main switch of the unit), and contact your local authorized Belmont dealer.

Phenomenon	Please check	Remedy
The chair does not move.	Is the main switch turned on?	Turn on the main switch.
	Is the breaker for the device on the switchboard of the dentist's office turned on?	Turn on the breaker for the device.
	Is the chair lock function activated?	Unlock the chair.
	Have you been operating the product continuously for a long time?	The overheating prevention device for the hydraulic motor has been triggered. Wait for approx. 10 minutes, and move the chair.

8 Accessories and Consumables

8-1 Accessories

IFU Information
Installation Instructions

8-2 Consumables

Consumables are parts that will normally wear or deteriorate, change their appearance, or become damaged after use. Please note that repair or replacement of consumables are not covered by the warranty and will be charged for.

(* Degree of wear, deterioration or damage and timing for replacement depends on the use environment and conditions at the customer's premises.)

Consumables (Parts listed below are out of the guarantee coverage and charged parts.)

- O-ring
- Packing

Exterior parts, including leather parts, metal parts, and resin parts, are not subject to warranty for such as scratches, dirt, deterioration and discoloration.



TAKARA COMPANY EUROPE GmbH

Industriestrasse 21, 61381
Friedrichsdorf, Germany



Albo-Healthcare GmbH

Alte Steinhäuserstrasse 19
CH-6330 Cham

 **Belmont**

TAKARA BELMONT CORPORATION

2-1-1, Higashishinsaibashi, Chuo-ku, Osaka, 542-0083, Japan

TEL : +81-6-6213-5945

FAX : +81-6-6212-3680

