



CLESTA eIII SWING
INSTRUCTIONS FOR USE

Dear Customers

Dear Customers

Thank you for purchasing our product.

This booklet explains how to use CLESTA eIII SWING. Before using CLESTA eIII SWING, carefully read the operating instructions and make sure to use the product correctly. Using the product without reading these instructions may lead to an accident.

For easy access to the information contained herein, keep this booklet at hand and review it as needed.

Ask your local authorized Belmont dealer to install this product by following the installation instructions contained in the product.

If you have any questions regarding the instructions for use or this product, contact your local authorized Belmont dealer. If you find any dirt on or damage to the booklet and need a new booklet, report the document number indicated below to your local authorized Belmont dealer to order a new one.

This document describes the full version of the system. It may therefore cover components that are not included in the system you purchased.

2024-08 (1st edition)	
Document number	1E0ACQA0

Dear Customers	1
1 General Information	
1-1 Intended Purpose of the Product	4
1-2 Compliance with Regulations and Directives	4
1-3 Declaration of Conformity	4
1-4 Compatible Medical devices	5
1-5 How to Dispose of the Device	5
1-6 Disposal of Residues	5
1-7 Concerning the water used for dental units	5
1-8 A notice to the user and/or patient.....	5
1-9 Symbols	6
2 Safety Consideration	
2-1 Risk Level Interpretation	8
2-2 Safety Precautions.....	9
Points to remember when operating the product	18
2-3 EMC Information.....	19
2-4 Compatible Handpieces	23
2-5 Compatible Chair	23
2-6 Compatible Dental Light	23
2-7 Safety precautions regarding water quality.....	24
3 Precautions for Use	25
4 Product Specifications	
4-1 Technical Data.....	26
4-2 Name of Each Part	28
5 Operation	
5-1 Preparation Before Use	29
5-2 After Use	30
5-3 Doctor Unit	31
5-4 Foot Controller.....	40
5-5 Cuspidor Unit	41
5-6 Right/Left handed dentistry conversion	43

6	Chair lock function	46
7	Adjustment	
7-1	Doctor Unit	47
7-2	Cuspidor Unit	47
8	Maintenance and Cleaning	
8-1	Doctor Unit.....	48
8-2	Cuspidor Unit.....	49
8-3	Washing and sterilizing the HVE and saliva ejector	51
8-4	Washing and sterilizing the 3WAY syringe	53
8-5	Junction Unit	58
8-6	Exterior	58
8-7	Maintenance and inspection	59
8-8	Detachable parts	62
8-9	Storage method	62
9	Maintenance by Service Engineers	
9-1	After-sales service	63
9-2	Service life	63
9-3	Period of Parts Retention	63
10	Troubleshooting	64
11	Consumables	65

1-1 Intended Purpose of the Product

This product is an active therapeutic device for dental diagnoses and treatment.

A qualified dentist shall operate the product, or dental staff shall use it under the supervision of a qualified dentist.

The qualified dentist or dental staff shall be responsible for the patient's entry/exit into/from the product, or for giving instructions or support to the patient.

Patients are not allowed to operate the product without special instructions.

This product shall be supplied with a micromotor, air turbine, air motor, air scaler, ultrasonic scaler and other parts.

In addition, it is the device which combines with dental chair and dental light.

1-2 Compliance with Regulations and Directives

This product complies with MDR (EU) 2017/745 and RoHS Directive 2011/65/EU.

1-3 Declaration of Conformity

We hereby declare that the product listed below complies with the general safety and performance requirements of the Medical Device Regulation: 2017/745 and RoHS Directive: 2011/65/EU based on category 8 of Annex I.

Product Type: DENTAL UNIT (CLASS II a)

Product Name: CLESTA eIII SWING

" CLESTA eIII SWING " has been defined by the rule 9 of MDR Annex VIII.

The product has been designed and manufactured in accordance with the European standards as listed in the Declaration of Conformity.

1-4 Compatible Medical devices

1-4-1 Compatible Handpieces

Select a handpiece from the list of compatible handpieces.
(For reference, see page 23.)

The connectors of our handpiece hose are designed and manufactured in accordance with ISO9168:2009 (DENTISTRY-HOSE CONNECTORS FOR AIR DRIVEN DENTAL HANDPIECES).

However, there still could be a case that the connectors of turbines or air motors may not fit into some handpieces due to the manufacturing tolerances.

Have your local authorized Belmont dealer to check the connectability before purchasing the handpiece.

Except for our recommended handpieces, we shall not be liable for any problems deriving from bad connectability or their performance.

1-4-2 Compatible Dental Chair

Please use the compatible dental chair described on page 23.

1-4-3 Compatible Dental Light

Please use the compatible dental light described on page 23.

1-5 How to Dispose of the Device

When disposing of this product and parts replaced, carefully take infection control measures and handle them properly in accordance with the relevant laws and regulations (applicable regulations and local regulations).

In the EU area, EU Directive 2012/19/EU (Directive on Waste Electrical and Electronic Equipment [WEEE Directive]) applies to this product.

Environment-conscious recycling/disposal is mandatory under this Directive.

1-6 Disposal of Residues

Ask a professional to dispose of amalgam residues.

1-7 Concerning the water used for dental units

In terms of water used for treatment, use drinking water with water quality conforming to the relevant local regulations or WHO guidelines.





















Although the water supply connection parts of this product is equipped with a backflow prevention mechanism, the use of handpieces with an anti-retraction device is strongly recommended when connecting to this product.

1-8 A notice to the user and/or patient





















Any serious incident that has occurred in relation to the device should be reported to the manufacturer and the competent authority of the Member State in which the user and/or patient is established.

1-9 Symbols

The symbols listed below are used on this product, on labeling, and in this booklet. Check the meaning of each symbol.

	Switch (ON)		Switch (OFF)
	Protective earthing		Switch for manual operation
LP	Switch for returning to the last position	0	Automatic return switch
1	Preset switch 1	2	Preset switch 2
	Switch for raising the chair		Switch for lowering the chair/headrest
	Switch for reclining the backrest		Switch for raising the backrest
	Cup filler switch		Bowl flush switch
	3 way syringe	IPX 1	Classification of foot controller
	Water/air flow control of syringe spray		
	Service coupler for air use		Service coupler for water use
	Micromotor rotation switch for normal/reverse		Power control of scaler
	Limit rotation speed control of micromotor		Alternating current
	Light change switch Sensor mode		Light change switch manual mode
W	Water	A	Air

1 General Information

	General warning sign *The base color yellow.		Caution *The base color yellow.
	Type B Applied Parts contacting the patient's body surface only		An autoclave symbol that indicates parts can be sterilized in an autoclave at temperatures up to 135°C
	Serial number		Catalog number
	Third-party certification stipulated in Medical Device Regulation: 2017/745 RoHS Directive 2011/65/EU		European Authorized Representative
	Name and address of the manufacturer		Manufacturing date and country
	Separate collection of electrical and electronic equipment		Follow instructions for use *The base color blue
	Generally prohibited activity		Disassembly, repair or modification prohibited
	Instructions for mandatory actions in general		Medical device
	Rated input		Rated voltage
	Dental unit		Dental patient chair
	Electronic instructions for use		

2-1 Risk Level Interpretation

Precautions before use

Make sure to carefully read the Safety Precautions and Operating Precautions and use the product correctly.

These precautions are intended to ensure the safe use of the product and prevent harm or damage to users or other people. According to the magnitude of harm and damage and the degree of urgency, an incident that may be caused by misuse of the product is classified into one of the following categories: CONTRAINDICATION, WARNING, and CAUTION.

All of these categories are important for safety. Always follow the instructions provided.

We assume no responsibility for any accident due to failure to follow the Safety Precautions or Operating Precautions even in the event of harm or damage to users or other persons.

In such case, users or other persons who use the product without observing the Safety Precautions and Operating Precautions are responsible for any harm or damage incurred. The graphical symbols are explained in detail below.

Once you have fully understood this explanation, read the text.

Classification by degree of harm or damage and urgency

CONTRAINDICATION

Use of the product without regard to this indication will create a hazardous condition that may result in death or serious injury.



WARNING

Improper handling of the product without regard to this indication will create a hazardous condition that may result in death or serious injury.



CAUTION

Improper handling of the product without regard to this indication will create a potentially hazardous condition that may result in moderate or slight injury or property damage.

The following graphical symbols are used to explain your responsibilities for using the product safely:

Graphical symbols for prohibited activity



Generally prohibited activity



Disassembly, repair or modification prohibited

Graphical symbol for mandatory instructions



Instructions for mandatory actions in general

2-2 Safety Precautions

CONTRAINDICATION



Precautions regarding installation

Do not install the product near electromagnetic sources such as communication facilities or elevators. Malfunction of this product may occur in the presence of electromagnetic interference waves.

Do not use the equipment in an explosive atmosphere (e.g., in the presence of inflammable gases).

Improper use in such an atmosphere may cause injury or fire.

Use with caution in the presence of electromagnetic waves.

Do not use equipment generating electromagnetic waves, such as mobile phones, around this product.

Malfunction of this product may occur.

Be sure to turn off the main switch of the product when HF surgical equipment is in use.

Be sure to turn off the main switch when HF surgical equipment is in use because the noise generated from HF surgical equipment may cause incorrect operation of this product.



Never disassemble, repair or modify the product.

Individuals other than your local authorized Belmont dealer should not disassemble or repair this product. This could lead to an accident, failure, electric shock, or fire.

Never modify the product as it is extremely dangerous.



WARNING



Precautions for installation

Ask your local authorized Belmont dealer to install the product.

Make sure to place the product on a firm and flat floor.

Placing the equipment on a non-flat floor may cause it to fall.

Be sure to ground the product securely. (Ask a professional to ground the product.)

Failure or electric leak may result in electric shock.

To avoid the risk of electric shock, this equipment must only be connected to a supply mains with protective earth.



WARNING

Be sure to turn off the breaker for devices when the product is not used for a long period of time.

product is not used for a long time for reasons such as closing time and non-consultation day. If the breaker is not turned off, a fire may be caused by a leakage of electricity due to insulation deterioration.

Be sure to turn off the main switch upon completion of work or during work breaks

Be sure to turn off the main switch upon completion of work or during work breaks. This prevents incorrect operation due to accidental contact and associated hazards.

Pay close attention to a patient who has a cardiac pacemaker or defibrillator implanted.

If any abnormality occurs, immediately turn off the main switch and discontinue use of the product.

CLESTA eIII SWING may affect the function of the pacemaker or defibrillator, leading to an accident.

Action taken for power failure

If the chair stopped at elevated position, chair will not go down. Help a patient to get off from the chair while paying attention to avoid patient's injury. Pay attention the chair doesn't fall down. When power comes back after power failure, to avoid unexpected movement, follow below instructions.

- Turn off the main power switch on dental unit.
- put the handpiece/syringe in the instrument holder/assistant holder.

Immediately wipe off any water spillage or leakage on the floor.

Decreased strength of the floor may cause the product to fall, leading to injury or damage to peripheral devices.

Do not wash the product with water.

This may cause failure or electric shock.

Clean the product thoroughly.

Poor cleaning may cause bacteria to grow, posing a health risk. See cleaning procedures on pages 48 to 58.



WARNING

Action to take in the case of a water leak

In the event of a water leak, close the main water valve, turn off the main switch and breaker for devices used in the clinic, and contact your local authorized Belmont dealer.

A load exceeding the weight limit (2kg) must not be applied to the doctor table

This may cause damage or injury.

Excessive load must not be applied to the arm

Excessive load must not be applied to the doctor arm, cuspidor arm and assistant arm. The patient must not sit on the doctor arm or assistant arm. This may cause injury due to falling, or damage to peripheral devices.

Use the turbine with a water check valve

Use the turbine with a water check valve. Contact the dealer or our company when a turbine without a water check valve will be used.

Do not sit on other than seat

When the backrest is at the forward position. Do not sit on or place an undue load on the headrest or legrest of dental chair. This could cause the unit to topple or could damage the unit.

Ensure the maintenance of this product

Be sure to perform maintenance inspection before use (startup inspection to confirm that the product functions normally). Operation without performing maintenance inspection may result in injury and damage to peripheral equipment.

Prohibition of maintenance

During operation, repair and maintenance are prohibited.

Prohibition of using this equipment adjacent to or stacked with other electronic equipment

Use of this equipment adjacent to or stacked with other equipment should be avoided because it could result in improper operation. If such use is necessary, this equipment and the other equipment should be observed to verify that they are operating normally.

Prohibition of placing portable RF communications equipment adjacent to this product

Portable RF communications equipment (including peripherals such as antenna cables and external antennas) should be used no closer than 30 cm (12 inches) to any part of CLESTA eIII SWING, including cables specified by the manufacturer. Otherwise, degradation of the performance of this equipment could result.



CAUTION

Only experienced personnel should use this product

Only dentists or other dental professionals should use this product.

Confirm safety before use

Before use, confirm that the parts are correctly and safely operating and that there are no obstacles around this product.

Close the water main valve and turn off the main switch upon completion of work

Be sure to close the water main valve and the main switch at the end of each workday to prevent water leakage from occurring.

Pay attention to patients and children

Keep your eyes on patients (especially, children) so that mischief or inadvertent operation of equipment will not lead to unexpected accidents.

Precautions for sterilization

Do not sterilize besides the procedures that we provide. This could cause damage to the unit.

Clean and sterilize the HVE tip, syringe nozzle before use

The HVE tip, syringe nozzle which contacts oral tissues, is provided without sterilization.

Cleaning and sterilization is necessary before use.

For the method of cleaning and sterilization, see "Care and Maintenance" on page 51 to 57.

Ensure that each part operates normally, with no abnormalities detected, before operation

Always inspect the product for abnormal findings such as loose components, backlash, tilting, vibration, sound, abnormal temperature, or bad odors.

If you feel something is wrong, immediately discontinue use of the product and turn off the main switch. Then, contact your local authorized Belmont dealer.

Read the accompanying documents for each device.

Before use, make sure to carefully read the instructions for use supplied with each device and use the device correctly.

Precautions when using water other than tap water

The water unit is intended for use with tap water. Caution should be exercised as the use of water other than tap water (water through a sterilizer or water systems, etc.) may result in failure of equipment.



CAUTION

Do not hit or rub the product

This may cause damage to the cover or operational failure.

Be sure to operate switches manually

Make sure to operate the switches manually, except for the foot controller operated by the foot and stick switches. Failure to operate the switches by hand may cause damage or malfunction.

Keep your eyes on the patient during operation

- Confirm that the patient is seated in the proper position before operation of the chair and keep your eyes on the patient during operation.
- Please make sure there are no children around a dental chair except a patient. Keep children off from a dental chair except a child patient gets dental procedures.
- Before operating the chair, confirm that there are no obstacles around this product.

Pay attention during the headrest operation

- During headrest operation, confirm that the patient's headrest is in proper position and keep your eyes on the patient during operation.
- Do not set a headrest at the position where a patient feels a pain.
- The headrest will be come off from the backrest in case of pulling too much.
- Do not allow hands, fingers or hair to become entangled in the moving parts of the headrest or between the headrest and backrest section during operation.

Pay attention during the armrest rotation

- Before rotating the armrest, confirm that there are no obstacles around the armrest.
- Do not operate the chair with the armrest swing out 90 degrees. Confirm that the armrest is locked position (normal position) before operating chair.

Cautions at adjusting the Dr table height

- Do not place objects on the table during table height adjustment.
- Turn off the main switch before adjusting the table height.
- Be sure to slide down the collar on the lock ring after removing the lock ring.
- Please confirm whether a table is fixed. If the table is not fixed surely, it causes a fall and the accident during operation.

Pay attention during movement of the Doctor's table

- Pay attention to surroundings when you move the Doctor's table. Injury by the tips of handpieces, etc., may occur.
- Be sure to move the Doctor's table by holding the handle of the unit.

2 Safety Consideration



CAUTION

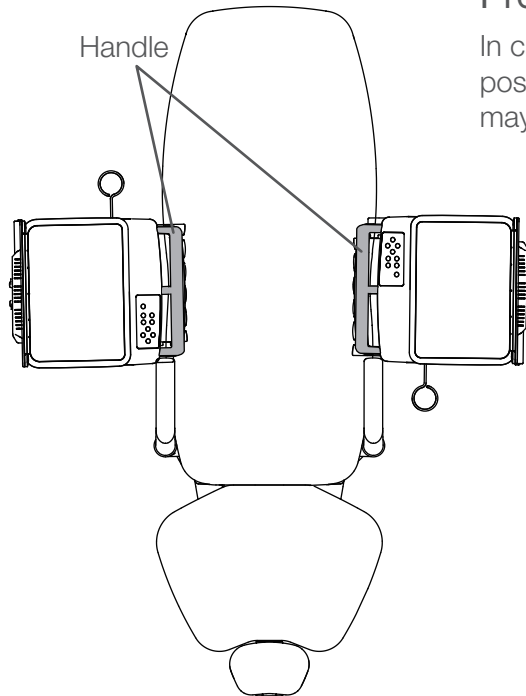

Precautions concerning the table position

In cases like cleaning, do not operate the chair while the table position (handle direction) is as shown in the figure because it may cause property damage.

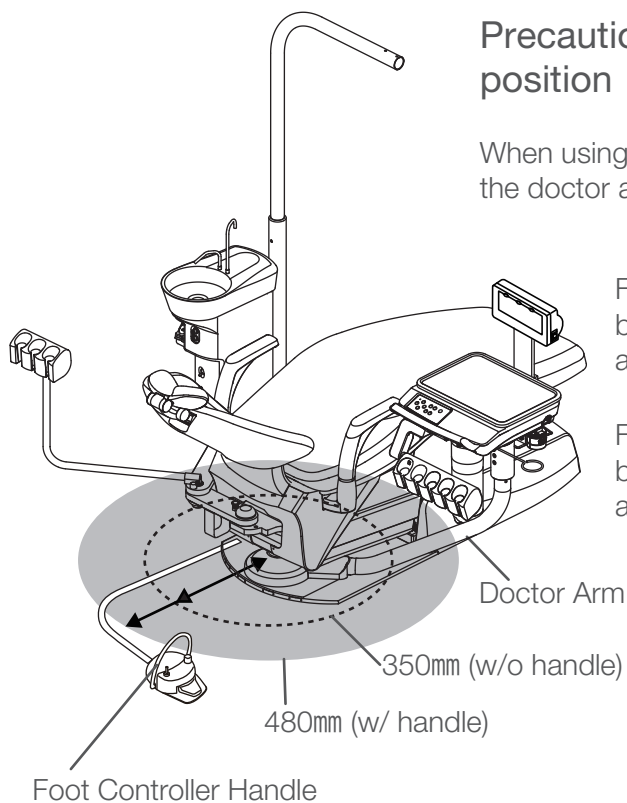

Precautions concerning the foot controller position

When using the foot controller, it may come in contact with the doctor arm, causing property damage.

For foot controller w/ handle, be sure to distance it 480mm away from the doctor arm rotating axis.

For foot controller w/o handle, be sure to distance it 350mm away from the doctor arm rotating axis.



CAUTION

Precautions when using an ultrasonic scaler

After use, attach a dedicated cover (if any) to the scaler tip and put it in an instrument holder. Contact with the tip of the scaler may cause injury.

Precautions when using a handpiece

In the event of heat or smoky smell, stop using the handpiece, turn off the main switch, and contact your local authorized Belmont dealer.

This may cause burns or have an adverse effect on the dental pulp.

Handling of the syringe and handpiece

Be careful not to drop the syringe and handpiece. Otherwise, it may break or the syringe and handpiece may deform.

Precautions for cleaning of the solid corrector

Clean the filter with running water. Do not use brush to clean the filter which may damage to the filter.

Use of flow rate adjustment knobs

- Flow rate adjustment knobs for water and air are intended to increase/decrease the flow rate. Caution should be exercised as tuning the knob excessively may cause it to turn free.
- There is cupfiller flow rate adjusting screw (pinch valve) for maintenance. The flow rate is adjusted when installing the unit.

Preventing subcutaneous emphysema

Excessive amount of air flow from the syringe may cause subcutaneous emphysema depending on the characteristics and location of the dental treatment.

When using the syringe, carefully adjust the amount of air flow with the Syringe Air flow control knob.

Concerning the control of air flow, refer to the page of "Adjustment".

Immediately wipe off drug solution when it comes into contact with this unit

Should drug solution or water come into contact with this unit, immediately wipe it off with a dry soft towel, etc. This could result in defective function or electric leakage as well as spotting or rusting.

Precautions for cleaning the HVE hose, saliva ejector hose

Always turn off the main switch before pulling the hose off to wash it.



CAUTION

Precautions when using a water bottle

The water bottle is intended only for use with purified water, distilled water and pure water. Do not use mouthwash or electrolyzed water, such as ConCool or povidone iodine, as they may cause clogged tubing or affect internal valves and equipment.

Set the pressure of the water tank at 200 kPa (0.2MPa) or less

Adjust the air supply pressure for the water bottle to 200 kPa (0.2MPa) or less. An excessively high pressure may cause damage to the water bottle.

Precautions for right/left handed conversion

- Make sure read through pages 43 to 45 for instructions before perform with right and left handed conversion. This could cause physical injury or property damage.
- Take care not to contact the doctor table to the cuspidor during conversion.
- Take care not to pinch the HVE hose and saliva ejector hose between the assistant arm and the cuspidor arm during this conversion.

Precautions when moving a stool

Pay attention to surroundings when moving a stool. Not to hit the doctor table or a foot controller. This could cause malfunction or damage to the unit.

Be careful not to heat an empty water heater

Exercise caution as heating of an empty water heater may result in burning of the heater, leading to fire.

Combination with other devices

Use only our qualified other devices or equipment for this product to ensure the safety of product.

Pay attention to allergic reaction of a patient

While the HVE tip, syringe nozzle is placed in a patient mouse, pay attention to allergic reaction. If allergic reaction start to happen, immediately stop the usage of the HVE tip, syringe nozzle.

Do not use the handpiece with its hose twisted

Repeated actions of picking up and returning the handpiece may cause its hose twisted. Check the hose periodically to see if it is not twisted. If twisted, unwind it before use. Continual use of the handpiece with its hose twisted will cause the kinks in the hose or breaking of the wire, making the handpiece unusable.

NOTICE

Troubleshooting and contact information

In the case of any problems, discontinue use, turn off the main switch and contact your local authorized Belmont dealer.

Check the operation of the compressor.

This product will not work unless air is supplied. Switch on the compressor before operating this product.

2 Safety Consideration

Points to remember when operating the product

Meaning of a symbol

- Point to remember
(locations requiring attention including moving parts, rotating parts, and detachable parts)
- Point to remember where an emergency stop mechanism is available

Meanings of each point to remember

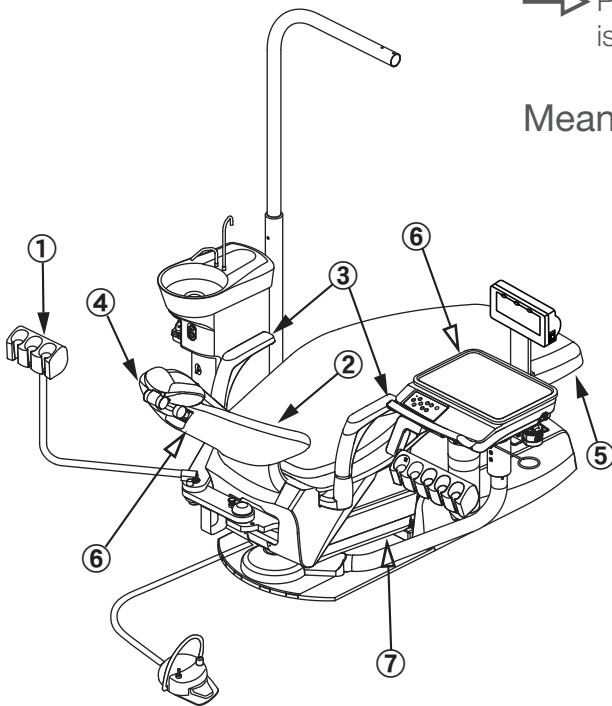

① Pay attention to prevent contact with the assistant holder.

The upper part of the patient's body should not lean forward over the cuspidor unit.

② Pay attention to prevent body parts or objects from becoming caught in the backrest moving parts.

Do not sandwich your hands or feet between the backrest and the seat.

③ Pay attention to prevent body parts or objects from becoming caught in the armrest (when rotating).

Do not operate the chair when the armrest is rotated.

④ Pay attention to prevent body parts or objects from becoming caught in the headrest moving part.

Ensure that your fingers and hair do not become caught in the headrest moving part.

⑤ Pay attention to prevent body parts or objects from becoming caught in the bottom of the seat.

Do not place your hands or feet in the bottom of the seat.

⑥ Pay attention to prevent contact of the chair with the doctor unit and assistant arm.

Do not place the doctor unit and assistant arm within the operational range of the chair.

⑦ Pay attention to prevent body parts or objects from becoming caught in the rear link cover.

Do not place the body parts or objects between the rear link cover and base plate.

2-3 EMC Information

This product complies with EMC Standard EN60601-1-2:2015 +AMD1:2021.

1. Precautions regarding EMC and compliance with accompanying documents

Medical electrical equipment requires special precautions regarding EMC and needs to be installed and put into service according to the EMC information provided in this booklet.

2. Effects of RF communication devices

Portable and mobile RF communication devices can affect medical electrical equipment.

3. Installation exclusion environment

Hospitals except for near active HF SURGICAL EQUIPMENT and the RF shielded room of an ME SYSTEM for magnetic resonance imaging, where the intensity of EM DISTURBANCES is high.

4. Electromagnetic emission declaration

Guidance and manufacturer's declaration—electromagnetic emissions			
CLESTA eIII SWING is intended for use in the electromagnetic environment specified below. The customer or user of CLESTA eIII SWING should ensure that it is used in such an environment.			
Emissions test	Compliance		Electromagnetic environment-guidance
	Japan	CE	
RF emissions CISPR 11	Group 1		CLESTA eIII SWING only uses RF energy for its internal functions. Therefore, its RF emissions are very low and are not likely to cause any interference with nearby electronic equipment.
RF emissions CISPR 11	Class B		CLESTA eIII SWING is suitable for use in all establishments, including domestic establishments and those directly connected to the public low-voltage power supply network that supplies buildings used for domestic purposes.
Harmonic emissions IEC 61000-3-2	Not applicable	Class A	
Voltage fluctuations/ Flicker emissions IEC 61000-3-3	Not applicable	Complies	



WARNING

Use of this equipment adjacent to or stacked with other equipment should be avoided because it could result in improper operation. If such use is necessary, this equipment and the other equipment should be observed to verify that they are operating normally.

5. Electromagnetic immunity declaration 1

Guidance and manufacturer's declaration – electromagnetic immunity			
CLESTA eIII SWING is intended for use in the electromagnetic environment specified below. The customer or user of CLESTA eIII SWING should ensure that it is used in such an environment.			
Immunity test	IEC 60601 test level	Compliance level	Electromagnetic environment - guidance
Electrostatic discharge (ESD) IEC 61000-4-2	±8 kV contact ±15 kV air	±8 kV contact ±15 kV air	Flooring should be wood, concrete, or ceramic tiles. If the floor is covered with synthetic material, the relative humidity should be at least 30%.
Electrical fast transient/burst IEC 61000-4-4	±2 kV for power supply lines ±1 kV for input/output lines	±2 kV for power supply lines ±1 kV for input/output lines	The mains power quality should be that of a typical commercial or hospital environment.
Surge IEC 61000-4-5	±1kV differential mode ±2kV common mode	±1kV differential mode ±2kV common mode	The mains power quality should be that of a typical commercial or hospital environment.
Voltage dips, short interruptions and voltage variations on power supply input lines IEC 61000-4-11	0% UT ; 0.5 cycles 0°, 45°, 90°, 135°, 180°, 225°, 270° and 315° 0% UT ; 1 cycle and 70% UT ; 25/30 cycles at 0°, single phase 0% UT ; 250/300 cycles	0% UT ; 0.5 cycles 0°, 45°, 90°, 135°, 180°, 225°, 270° and 315° 0% UT ; 1 cycle and 70% UT ; 25/30 cycles at 0°, single phase 0% UT ; 250/300 cycles	The mains power quality should be that of a typical commercial or hospital environment. If the user of CLESTA eIII SWING requires continued operation during mains power interruptions, it is recommended that CLESTA eIII SWING be powered from an uninterruptible power supply or a battery.
Power frequency (50/60 Hz) magnetic field IEC 61000-4-8	30A/m	30A/m	Power frequency magnetic fields should be at levels characteristic of a typical location in a typical commercial or hospital environment.
Proximity magnetic fields IEC 61000-4-39	134.2kHz 65A/m, Pulse Modulation 2.1kHz 13.56MHz 7.5A/m, Pulse Modulation 50kHz	134.2kHz 65A/m, Pulse Modulation 2.1kHz 13.56MHz 7.5A/m, Pulse Modulation 50kHz	Proximity magnetic fields should be at levels characteristic of a typical location in a professional healthcare facility environment.
Note UT is the AC mains voltage prior to the application of the test level.			

6. Electromagnetic immunity declaration 2

Guidance and manufacturer's declaration—electromagnetic immunity			
CLESTA eIII SWING is intended for use in the electromagnetic environment specified below. The customer or user of CLESTA eIII SWING should ensure that it is used in such an environment.			
Immunity test	IEC 60601 test level	Compliance level	Electromagnetic environment - guidance
Conducted RF IEC 61000-4-6	3V 0.15MHz-80MHz 6V 0.15MHz-80MHz in ISM bands and amateur radio bands	3V 0.15MHz-80MHz 6V 0.15MHz-80MHz in ISM bands and amateur radio bands	Warning: Portable RF communications equipment (including peripherals such as antenna cables and external antennas) should be used no closer than 30 cm (12 inches) to any part of CLESTA eIII SWING, including cables specified by the manufacturer. Otherwise, degradation of the performance of this equipment could result.
Radiated RF IEC 61000-4-3	3V/m 80MHz-2.7GHz 80% AM (1 kHz)	3V/m 80MHz-2.7GHz 80% AM (1 kHz)	
Near electromagnetic field caused by RF wireless communication devices IEC61000-4-3	See the table on the next page (page 22)	See the table on the next page (page 22)	

7. Essential performance

Unless operated by the chair control switch, the chair will not make any movements.

Unless operated by the foot controller, the handpiece will not move except for sounding a buzzer and switching the indicator on/off.

Loss or decline of essential performance may cause the chair or handpiece to move unexpectedly, causing harm or damage to the patient, operator or people or objects around the patient or operator.



WARNING

Portable RF communications equipment (including peripherals such as antenna cables and external antennas) should be used no closer than 30 cm (12 inches) to any part of CLESTA eIII SWING, including cables specified by the manufacturer. Otherwise, degradation of the performance of this equipment could result.

Near electromagnetic field caused by RF wireless communication devices

Test frequency (MHz)	Modulation	IEC 60601 test level	IEC 60601 compliance level
385	Pulse modulation a) 18Hz	27V/m	27V/m
450	Frequency modulation ±5kHz shift 1kHz sine wave	28V/m	28V/m
710 745 780	Pulse modulation a) 217Hz	9V/m	9V/m
810 870 930	Pulse modulation a) 18Hz	28V/m	28V/m
1720 1845 1970	Pulse modulation a) 217Hz	28V/m	28V/m
2450	Pulse modulation a) 217Hz	28V/m	28V/m
5240 5500 5785	Pulse modulation a) 217Hz	9V/m	9V/m
Note a) The carrier is modulated by a square wave with a 50% duty cycle.			

2-4 Compatible Handpieces

The following handpieces are compatible with this product:

Syringe	SYR-20
	BT14
	DCI 3Way
Air Turbine	NSK Ti-Max Z Series
	NSK Ti-Max X Series
	NSK S-Max M Series
	NSK Pana Max Plus Series
	NSK Pana Max 2 Series
Air motor	NSK EX-203 Series
	NSK FX205 Series
	NSK S-Max M205 Series
	NSK Ti-Max X205 Series
Micromotor	NSK Ti-Max NLX nano / NLX PCB
	BIEN AIR MCX / DMCX PCB.
	BIEN AIR MCX / DMCX PCB./ OPTIMA INT
Contra-angle	NSK Ti-Max X Series
	NSK Ti-Max Z Series
	NSK S-Max M Series
	NSK FX Series
	NSK EX Series
	BIEN AIR CA 1:1
Straight	NSK EX-6 Series
	NSK Ti-Max X65 Series
	NSK S-Max M65 Series
	NSK FX65 Series
	BIEN AIR PM 1:1
Scaler	EMS PIEZON NO PAIN
	EMS PIEZON NO PAIN LED
	SATELEC SP4055 NEWTRON / SP4055 NEWTRON Module
	SATELEC SP4055 NEWTRON LED / SP4055 NEWTRON Module with LED Drive Board
	NSK Varios 170
	NSK Varios 170 LUX
	ACTEON XINETIC
Curing light	SATELEC MINI LED STD OEM

Series of Air turbine, Air motor, and Contra-angle/ Straight have been confirmed the combination of this products.
Using the Series mentioned above is recommended.

2-5 Compatible Dental Chair

Dental chair	CLESTA eIII CHAIR (SWING TYPE)
--------------	--------------------------------

2-6 Compatible Dental Light

Dental light	EURUS LIGHT
--------------	-------------

2-7 Safety precautions regarding water quality



CAUTION

Conduct flushing before treatment.

If this product is not used for a long time, water retained in ducts and in the water heater will be susceptible to bacterial growth. To provide safe treatment and operate the handpiece without any trouble, never forget to perform flushing (discharge) of the water lines before starting treatment.

To inhibit the growth of various bacteria, you are recommended to carry out flushing with fresh water at the end of treatment in the morning and evening.

Time required for standard flushing of the unit water lines

Flushing water circuits of handpieces	
Air turbine	40 seconds
Micromotor	
Air motor	
Ultrasonic scaler	
Syringe	

Flushing the water circuits of cupfiller and cuspidor bowl	
Cupfiller	5 minutes
Bowl flush	

Preparation of flushing

[Reference]
 Preparing handpieces for flushing [pages 30]
 BT14 Syringe [pages 55]

Procedure of flushing

Handpiece line	
Without flushing function	Press the foot controller to flush of the handpiece water.
With flushing function	Pick up the handpieces then turn on the flushing switch to flush the handpiece water. [Reference pages 30]

cuspidor line	
The water filled to the cup, then drain the water of the cup to flush the cupfiller water. Repeat it 7~8 times.	

3 Precautions for Use

Operating Precautions

Do not apply heat to the product.

This may cause deterioration or discoloration.

Precautions for cleaning the product exterior

- If the exterior is excessively dirty, moisten a soft cloth with water containing approx. 10% neutral detergent, and wipe the exterior with the cloth. Then, wipe it with a cloth moistened with water and then dry it completely with a dry cloth.
- Never use any of the products listed below:
Volatile chemicals such as paint thinner, butanol, isopropyl alcohol, nail-varnish remover, gasoline, or kerosene; acid, alkaline or chlorine detergents; highly corrosive disinfectants (povidone-iodine such as Isodine, sodium hypochlorite, etc.); abrasive polishing wax or abra-sive sponge.
solution. Wipe off water and residual disinfectant immediately.
- If water or detergent is left on the surface, wipe it off immediately. Moisture or detergent may cause rust or failure of electrical parts.

Precautions for cleaning the cuspidor bowl

- Never use sandpaper, metal scrub brushes or abrasive cleaning agents to clean the cuspidor bowl.
- Do not use strongly acidic cleaning agents or alkaline pipe cleaning agents, which may cause of metals, etc.
- Be careful not to apply unnecessary force to it when cleaning. (Be careful not to hit or drop it.)

Precautions for cleaning the suction line

Do not use any detergent except our designated one. Otherwise, strong acidic detergents or alkaline drain preparations may cause clog, damage, or metal corrosion.

Precautions for cleaning the instrument Holder/assistant Holder

- Do not spray detergent directly onto the exterior.
Clean the surface with a soft cloth or paper towel moistened with detergent, and wipe it with a dry cloth. If liquid enters the product, it may cause a malfunction or failure.
- Confirm that the detergent has completely evaporated before activating the product.

4 Product Specifications

4-1 Technical Data

Catalog number	AU-E3S-SWE23CE/AU-E3S-SW23VCE/ AU-E3S-SWCUS
Classification for protection against electric shock	Class I Equipment
Classification according to the degree of protection against electric shock	Type B Applied Parts (handpiece)
Classification according to the degree of protection against ingress of water or particulate matter	Foot controller IPX1
Rated voltage	AC230 V
Power frequency	50/60 Hz
Power input	1.4A (Dental unit) 3.4A (Dental unit with chair)
Fuse	Primary circuit: 5A/250V Low breaking capacity Operating speed: Time lag Size: 5.2 × 20 mm
Weight	66.3Kg (without dental light)
Weight limit	Doctor table 2 kg
Air supply	
Main air pressure	0.5MPa
Filter mesh size	50µm
Minimum flow rate	100L/min
Air purity-class	Particle class 2/Humidity class 4/ Oil content class 2
Water supply	
Main water pressure	0.2MPa
Filter mesh size	100µm
Minimum flow rate	6L/min
water hardness limit	Less than 2,14 mmol/l
pH limits	6.5 to 8.5
Suction system	Semi-dry system
Suction air volume flow rate	Type 1: high-volume
Usage environment	Temperature 0°C to 40°C Humidity 10% to 95% Atmospheric pressure 700 to 1060 hPa
Transportation/storage environment	Temperature -20°C to 70°C Humidity 10% to 95% Atmospheric pressure 700 to 1060 hPa
Adaptation to high-oxygen environment	The product is not suitable for use in a high-oxygen environment.

Refer to the rating plate for the capacity of power supply.

4 Product Specifications

Dimensional drawing (standard values are provided)

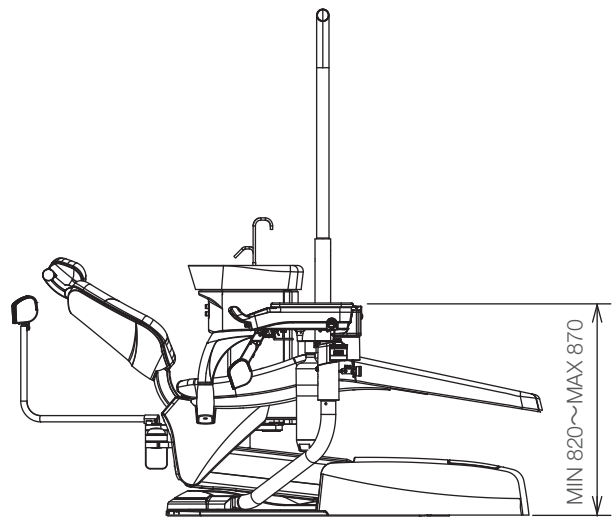
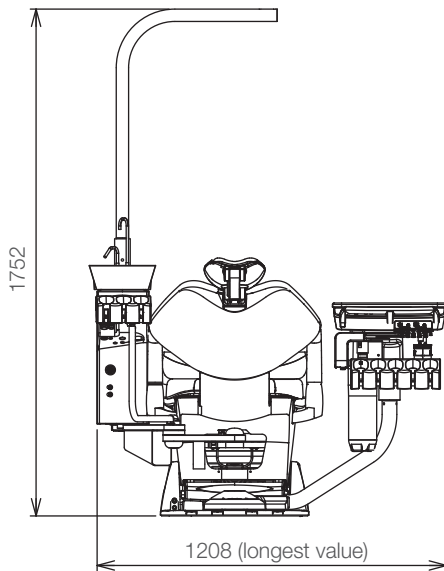
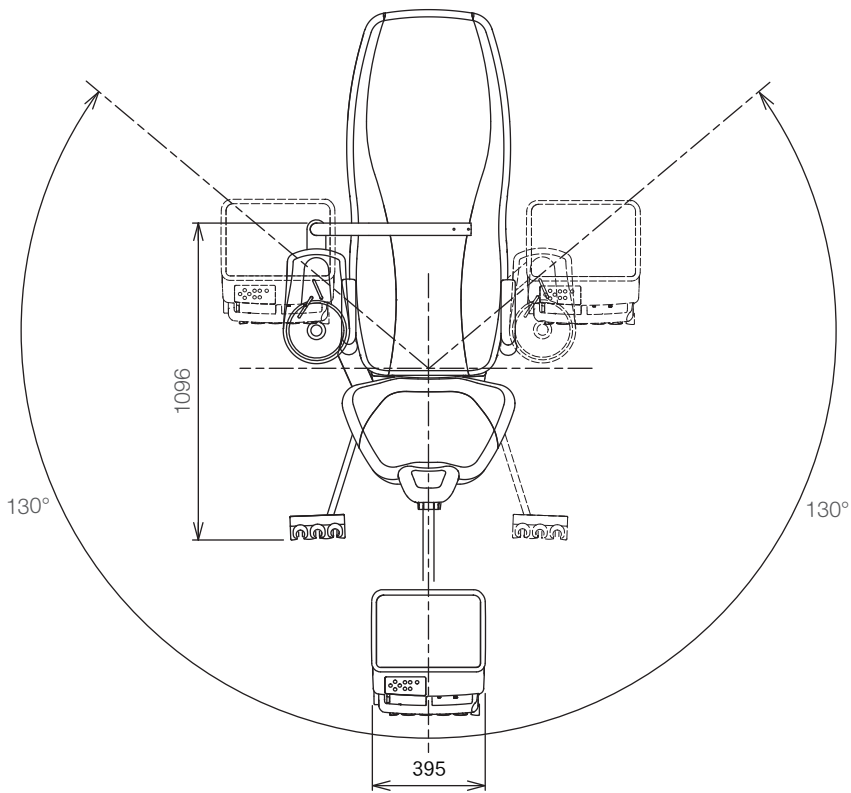

Unit: mm
Tolerance in dimensions: $\pm 10\%$

4 Product Specifications

4-2 Name of Each Part

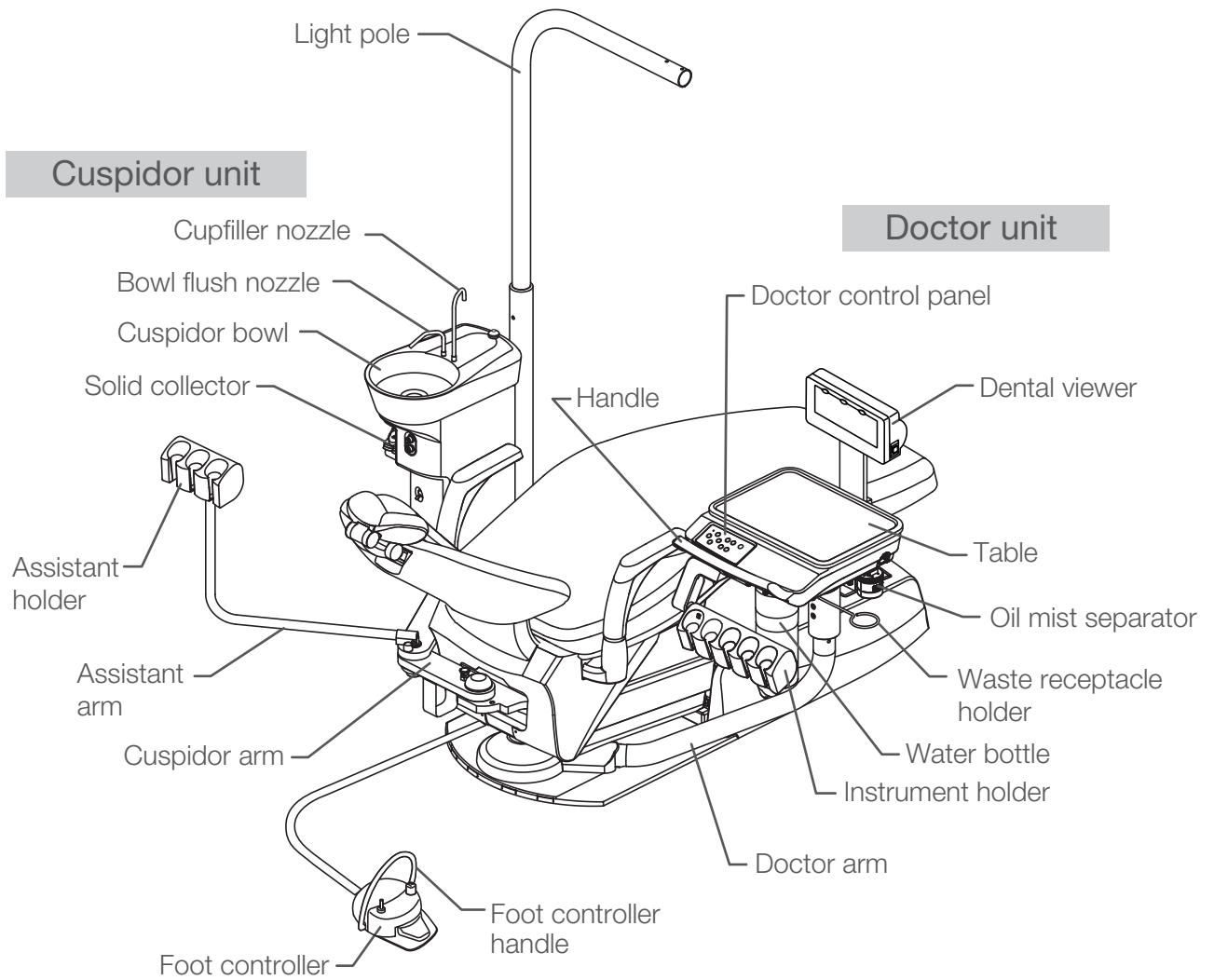

Junction unit

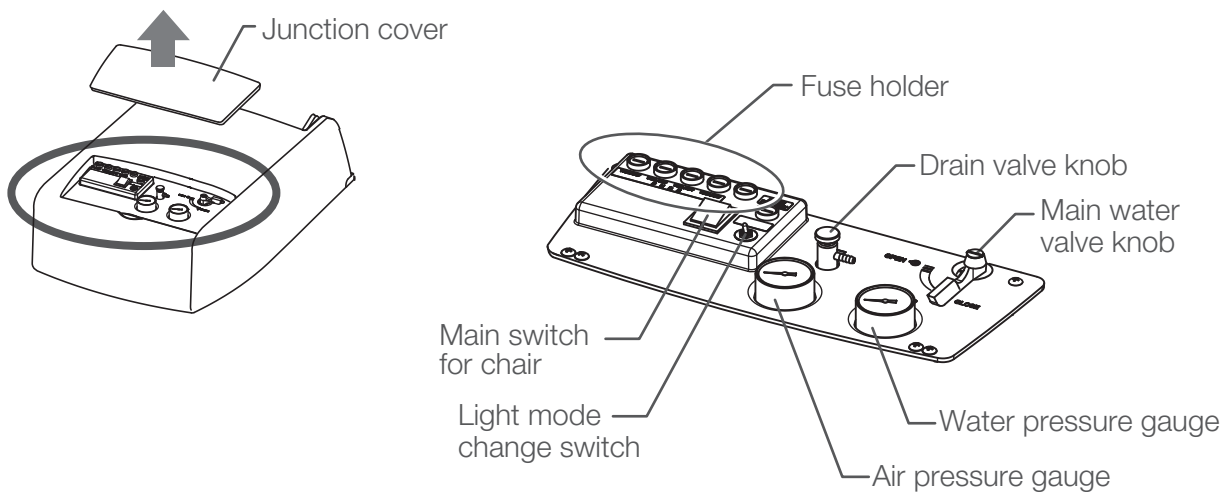

5-1 Preparation Before Use

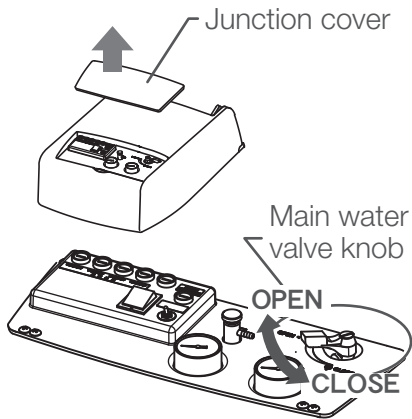

(1) With no air supplied, this product does not operate even after turning on the main switch.
Turn on the power of the compressor before turning on the main switch.

(2) Remove the junction cover.
Turn the main water valve knob clockwise to the open side.

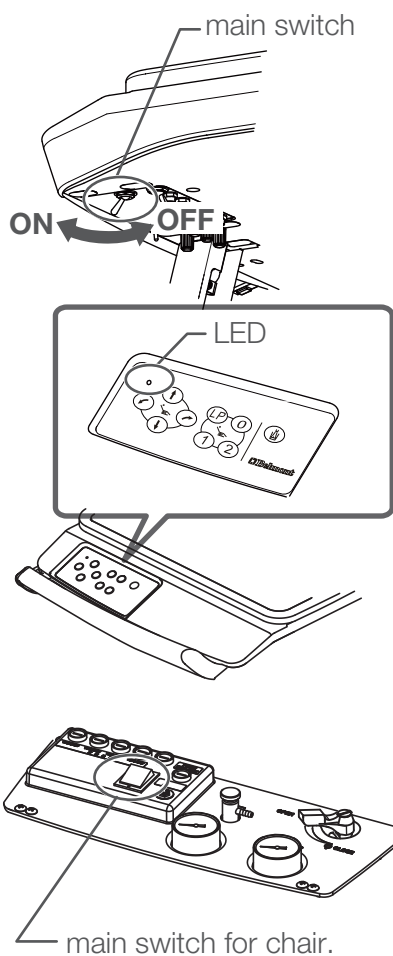

(3) Turn on the main switch to forward as viewed the doctor table from the front, the main switch indicator on the front of the cuspidor unit will lights up in green, this state permits motion of the unit.

(4) Turn on the power for chair.
Press the main switch for chair.
* When turned on, the switch will illuminate.

WARNING

Be sure to turn off the main switch upon completion of work or during work breaks. This prevents incorrect operation due to accidental contact and associated hazards.

5-2 After Use

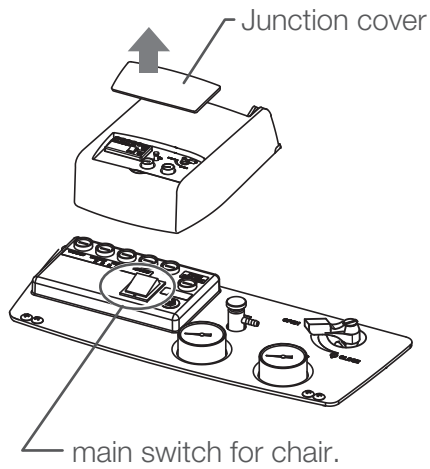

- (1) Remove the junction cover.
Turn off the power for chair.
Press the main switch for chair.
When turned off, the light goes off.

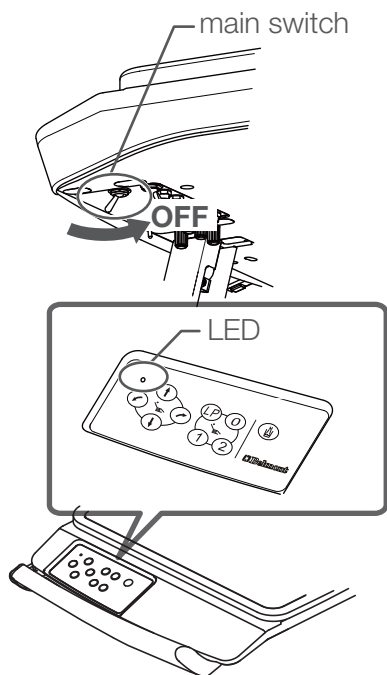

- (2) Turn on the main switch to backward as viewed the doctor table from the front.
When turned off, the led goes off.

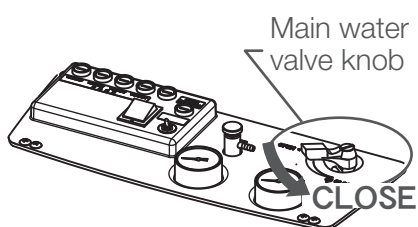

- (3) Close the water main valve
Turn the main water valve knob counterclockwise to the close side.

5-3 Doctor Unit

(1) Flushing switch

Flushing switch is located underneath the doctor table. Pick up a handpiece from the handpiece holder, then turn on the flushing switch by pushing the lever to the ON side. While pushing the lever, coolant water from the handpiece keeps coming out. To stop the flushing, take your finger off the lever.

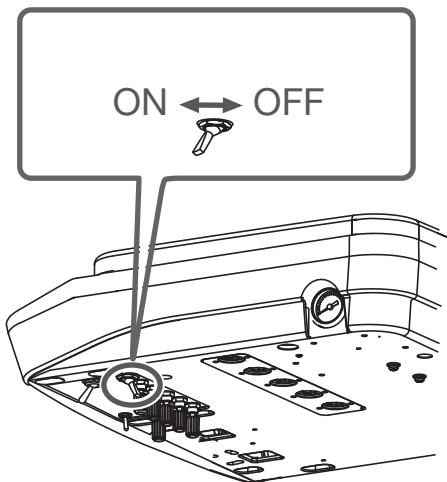

Preparing handpieces for flushing

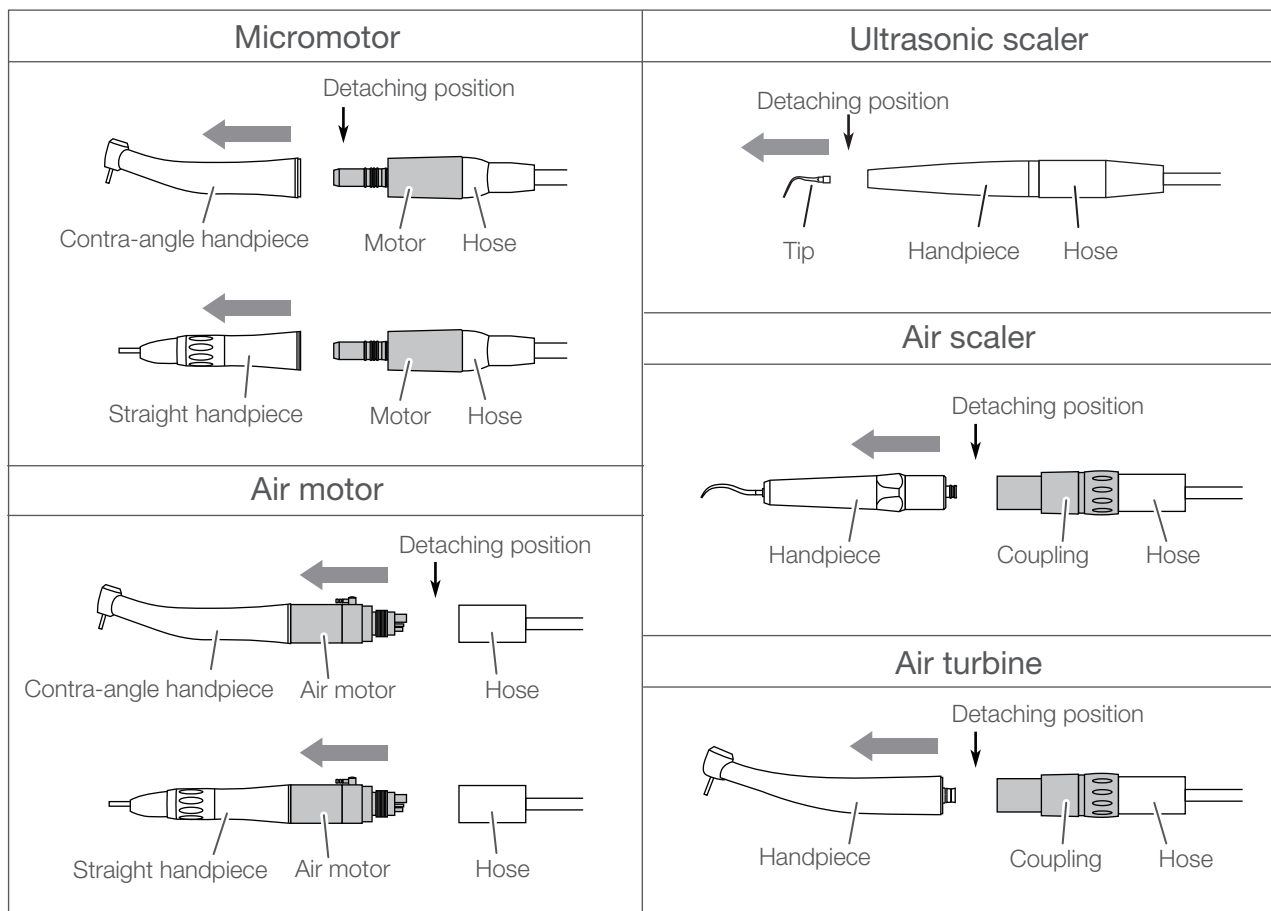

After flushing, wipe the handpiece with a soft cloth to remove excess moisture.

When picking up the handpiece after flushing, remaining air may be discharged. This is normal.

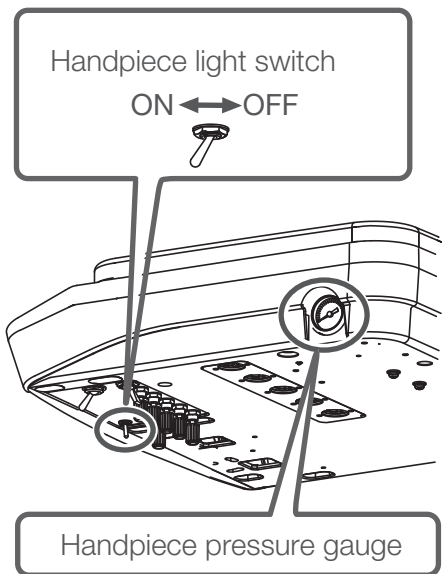

(2) Handpiece light switch **E Type**

Turns on/off the handpiece light. Switching between on and off of the handpiece light occurs each time when this switch is changed to forward (on) and backward (off) as viewed from the front.

(3) Handpiece pressure gauge

Displays the handpiece drive air pressure.

(4) Handpiece

The handpiece is actuated by picking it up from the handpiece holder and operating the foot controller. Operation of the each handpieces, please refer to the manufacturer's instruction manual attached to the individual equipment. Use the handpieces described on pages 23.

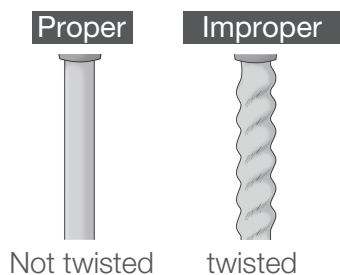

CAUTION

Repeated actions of picking up and returning the handpiece may cause its hose twisted. Check the hose periodically to see if it is not twisted. If twisted, unwind it before use. Continual use of the handpiece with its hose twisted will cause the kinks in the hose or breaking of the wire, making the handpiece unusable.

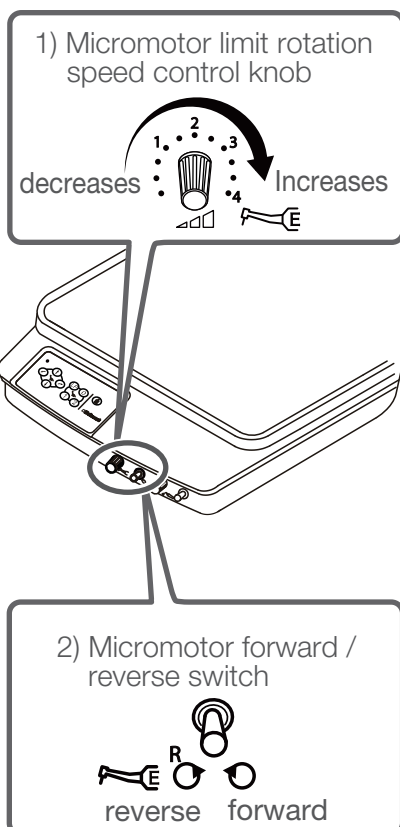

(5) Micromotor **E Type**

1) Micromotor limit rotation speed control knob

The knob controls the upper limit speeds in micromotor rotation.

If the knob is turned right, the upper limit speed increases, and if left, the speed decreases.

2) Micromotor forward / reverse switch

The switch changes the rotation direction in micromotor.

If the switch is turned to the right side, the motor rotates clockwise, if left side, the motor rotates counter-clockwise.

CAUTION

- Be sure if the micromotor stops before changing the rotation direction.
- Read carefully the attached each micromotor's appendix and the manual. Use them correctly accordingly.

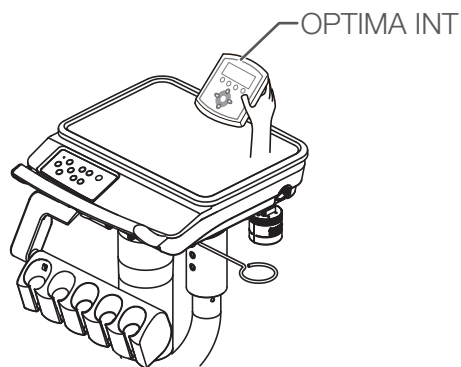

3) BIEN AIR MCX OPTIMA INT

For the operation of Bien Air OPTIMA INT, press the button with the thumb, holding the back of the controller with the other fingers.

Pressing the button without holding the controller, the doctor table may move.

Read carefully the attached Bien Air OPTIMA INT's appendix and the manual. Use them correctly accordingly.

1) Ultrasonic scaler output power control knob

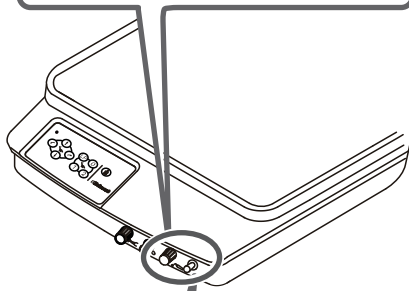
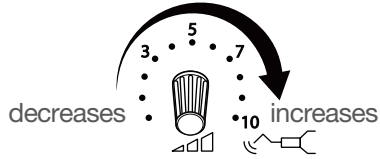

2) Ultrasonic scaler Perio/Endo/Scaling switch



3) Ultrasonic scaler light switch

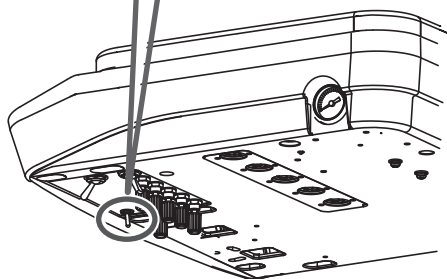

(6) Ultrasonic scaler **A Type** **E Type**

1) Ultrasonic scaler output power control knob

The knob adjusts the output power of the ultrasonic scaler.

If the knob is turned right, the output power increase, and if left, the power decreases.

2) Ultrasonic scaler Perio/Endo/Scaling switch

The switch can be selected from “Perio (P)”, “Endo (E)”, and “Scaling (S)”.

* When using NO PAIN, XINETIC, the mode cannot be selected.

3) Ultrasonic scaler light switch

Turns on/off the Ultrasonic scaler light.

Switching between on and off of the Ultrasonic scaler light occurs each time when this switch is changed to forward (on) and backward (off) as viewed from the front.

CAUTION

- Be sure to put the scaler’s tip cover on or remove the tip before putting back the ultrasonic scaler to the holder to avoid being hurt by the tip.
- Read carefully the attached each scaler’s appendix and the manual. Use them correctly accordingly.

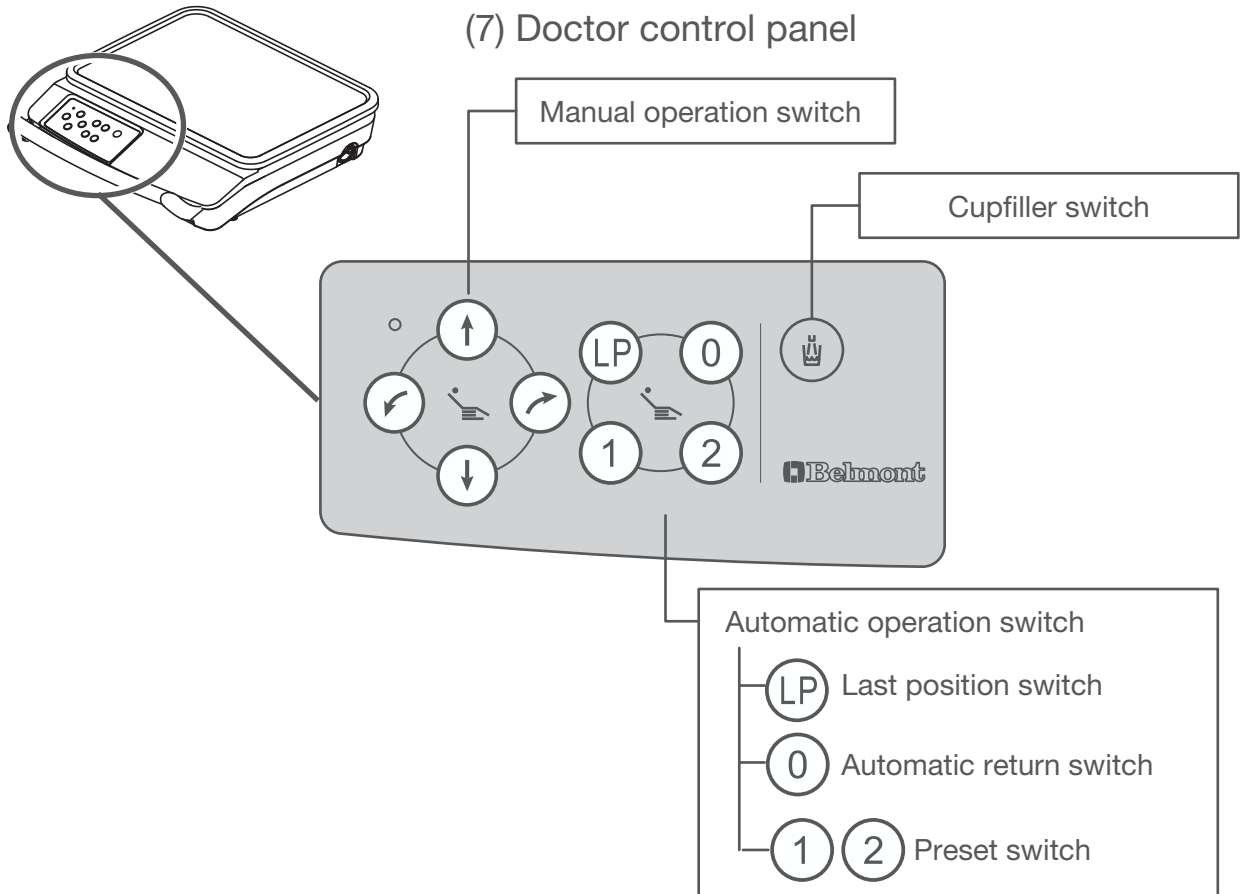

Cupfiller switch

When this switch is pressed, water is released from the cupfiller nozzle. Water is also released from the bowl flush nozzle to flush the cuspidor bowl. Cupfiller operates by timer for a specified time period.

Cupfiller operates for a specified time period, regardless of the water level in the cup. Be careful not to overflow the cup. Do not press the switch while the cup is not in place.

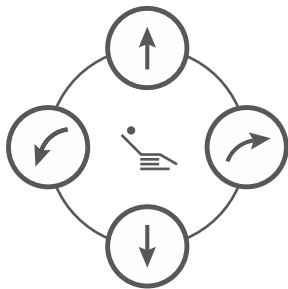

Manual operation switch

Raising/lowering the chair and raising/reclining the backrest

switch	Operation
	The chair is raised
	The chair is lowered
	The backrest is reclined
	The backrest is raised



Move the chair to mouth rinsing position by chair manual switch

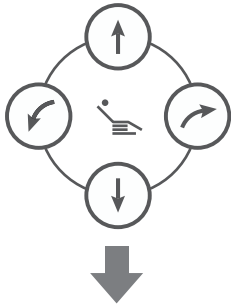

Press and hold the LP switch for approx 5 seconds.



Move the chair to treatment position by chair manual switch

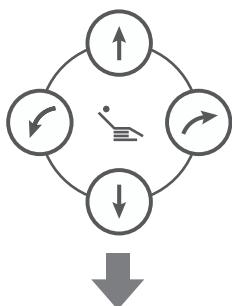

Press and hold the preset switches for approx 5 seconds.



Automatic operation switch

Last position switch

The chair is moved to the preset “mouth rinsing position”. By pushing again after movement completion, the chair is moved to the position prior to the “mouth rinsing position”.

【Setting the mouth rinsing position】

1. Move the chair to the preset mouth rinsing position using the manual control switch.
2. Press and hold the last position switch **LP** for approx 5 seconds. A beep sounds, and the chair is set to the position.
3. To change the set position, perform the procedures steps 1 and 2 above.

Automatic return switch

The chair is moved to the entry/exit position.

Press any switches (chair/unit) for stopping the automatic movement.

Preset switch

- When **①** is pressed, the chair is moved to treatment position 1.
- When **②** is pressed, the chair is moved to treatment position 2.

【Setting the treatment position】

1. Move the chair to the treatment position using the manual control switch.
2. Press and hold the preset switch **①** or **②** for approx 5 seconds. A beep sounds, and the chair is set to the position.
3. To change the set position, perform the procedures steps 1 and 2 above.



CAUTION

Make sure to operate the switches manually. Failure to operate the switches by hand may cause damage or malfunction.

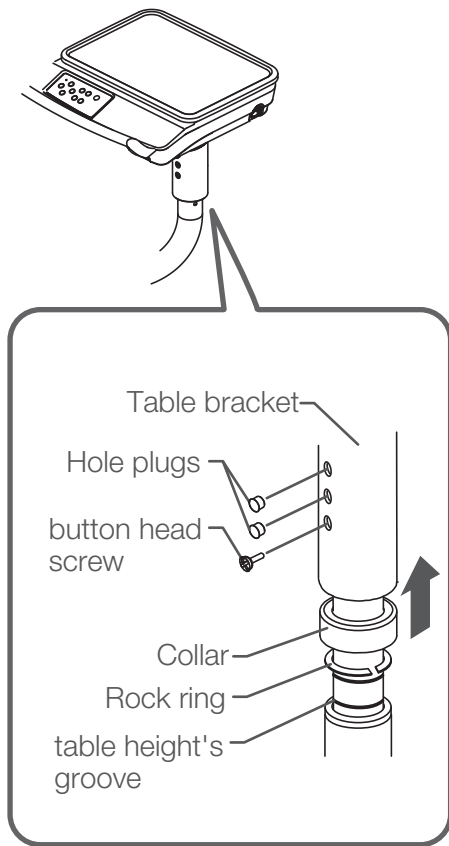

(12) Table height adjustment

Doctor table height can be adjusted 3 positions. Hold and slightly lift up the doctor table, rock ring will come up on table bracket. Slide up or down the rock ring to appropriate groove on upper table bracket. Lower the doctor table to fix it at that height. Please confirm that a table is fixed to the lower course surely then.

How to adjust the height

- 1) Unscrew the button head screw M6. **【Tool: Use a hexagonal wrench】**
- 2) Remove the hole plugs (2 places). **【Tool: Use a flathead screwdriver】**
- 3) Lift the doctor table.
- 4) Move the lock ring to the desired table height's groove.
- 5) Return the table bracket.
- 6) Insert the button head screw M6 in the hole corresponding with the position of the lock ring.

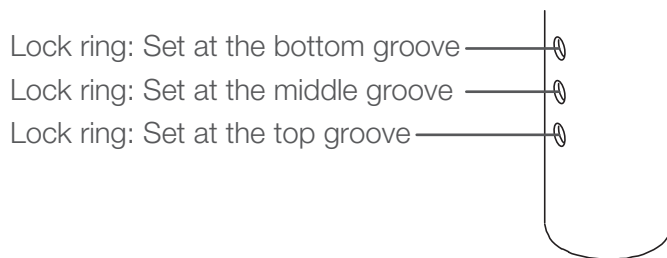

- 7) Insert the hole plugs (2 places) in the open holes.

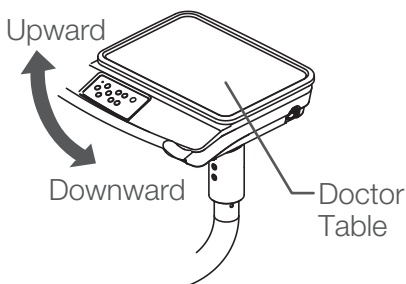

Locked functions

When the force is applied to the doctor table from the upward/downward direction during the automatic operation of the chair.

WARNING

When adjusting the table height, confirm that the main switch is turned off. Accidentally pressing the switches or foot pedal will lead to unexpected operation of the product, which may cause injuries.

【Doctor side】

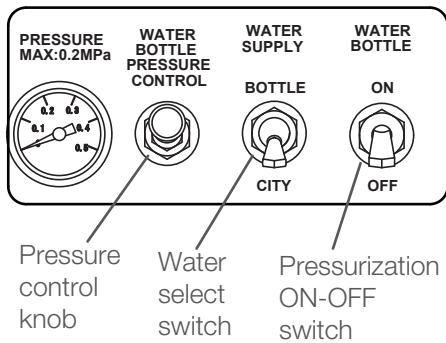
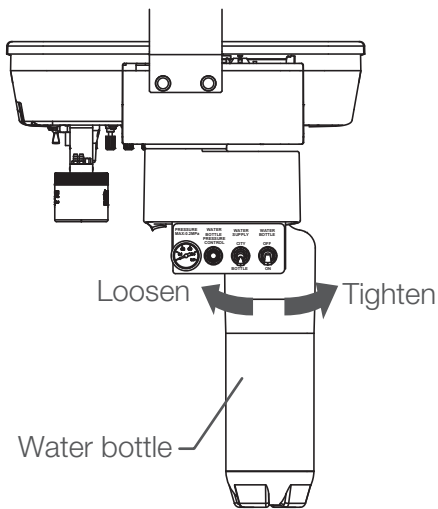

【Cuspidor side】

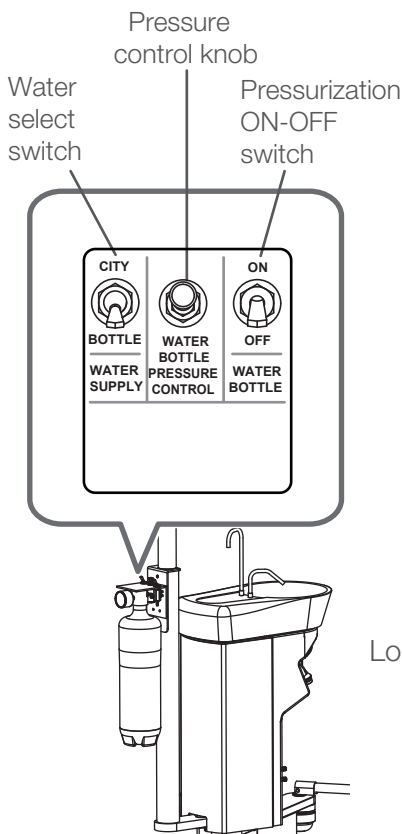

(13) Water bottle Doctor side Cuspidor side

The water bottle CITY/BOTTLE select switch can be changed between municipal water and water bottle.

CITY Tap water
BOTTLE . . . Water bottle

When the pressurization ON-OFF switch is set to ON, the water bottle may be used.

The pressure control knob adjusts the pressure of water bottle.
The pressure increase when the knob is turned clockwise, and decrease when the knob is turned counterclockwise.

Replacing the water bottle

[How to remove the water bottle]

- 1) Flip the pressurization ON-OFF switch to the down (OFF).
- 2) Turn the water bottle and remove it.
Turning it counterclockwise will loosen the connection.
Turning it clockwise will tighten the connection.

[How to attach it]

Reattach it in the reverse order of remove.

When not using the water from the water bottle, flip the water select switch to the CITY.

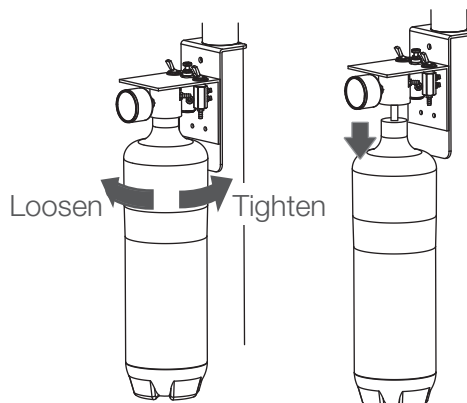

SYR-20

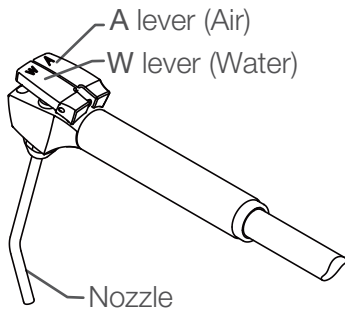

(14) 3WAY Syringe SYR-20 BT14

(1) Spraying water / air

Press W lever to have water come out.

Press A lever to have air come out.

Press both levers simultaneously to have spray come out.

Water comes out from the center of the tip, and air comes out from the circumference of the tip.

BT14

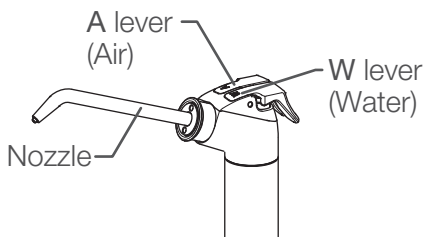

(2) Rotation of the nozzle

Nozzle rotates through 360°.

If the air is provided immediately after the usage of water or attaching the nozzle, a little water remaining in the nozzle may come out. When providing air, press the A lever for two or three times to confirm that water does not come out.

Tip of the nozzle (Common to all types)

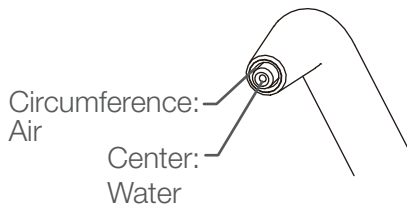

5-4 Foot controller

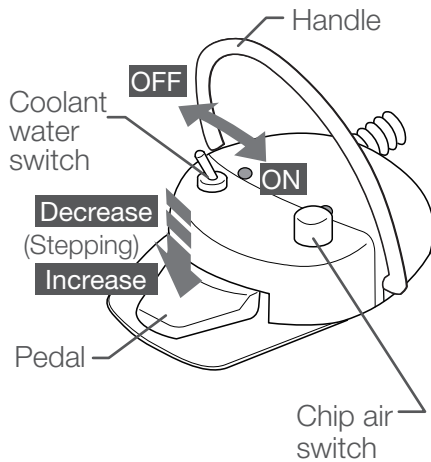

Pedal

The pedal depressing extent can control the turbine and air motor rotation speed and air scaler output.

The micromotor rotation is activated when the pedal is depressed. Adjust upper limit speed by turning micromotor limit rotation speed control knob.

The electric scaler is activated when the pedal is depressed. Adjust the scaler power by turning output power control knob.

Coolant water switch

Spray water ON/OFF switch allows water to be turned on or off.

Chip air switch

Air is discharged from the chip of the micromotor or air turbine /motor.

Foot controller handle

The foot controller can be moved by hanging it over the foot.

5-5 Cuspidor unit

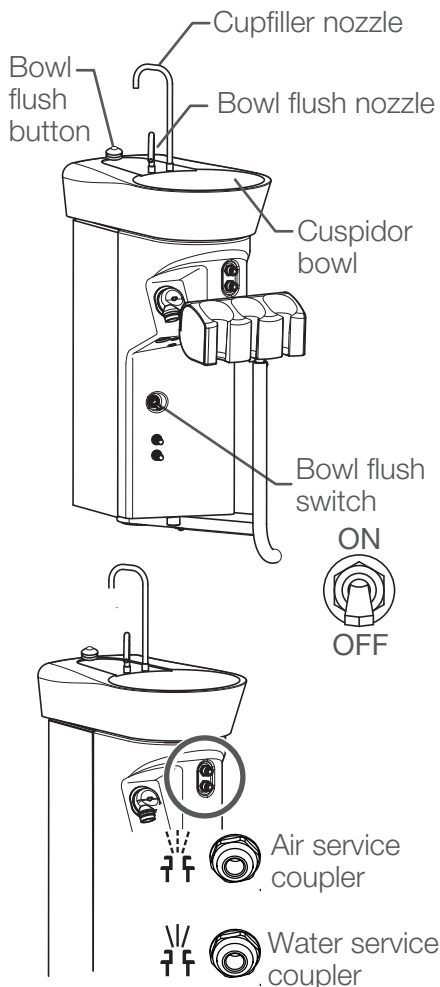

(1) Cupfiller switch

When this switch is pressed, water is released from the cupfiller nozzle.

Water is also released from the bowl flush nozzle to flush the cuspidor bowl.

Cupfiller operates by timer for a specified time period.

Cupfiller operates for a specified time period, regardless of the water level in the cup.

Be careful not to overflow the cup.

(2) Bowl flush button

When this switch is set to ON, water is released from the Bowl flush nozzle.

Bowl flush operates by timer for a specified time period.

(3) Water service coupler

This switch turns on the water supply to an external device.

Quick connector for water service outlet

Model number: MCL-04NH-1B

(4) Air service coupler

Supplies air to an external device.

Quick connector for air service outlet

Model number: MC-04PH

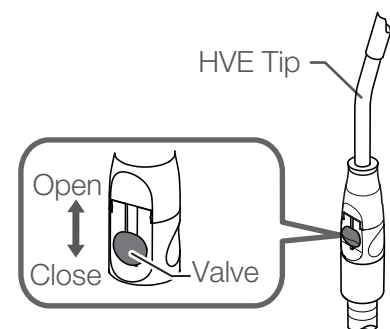

(5) VH-18 HVE (High-volume evacuator)

Take the HVE out of the assistant holder, and suction will start.

Since a delay circuit is provided, suction does not stop immediately when the HVE is returned to the assistant holder.

In case of the central suction system, suction will continue for approx. 3 seconds.

The suction volume may be controlled by opening or closing the valve.

Tip size : $\Phi 11/\Phi 16$

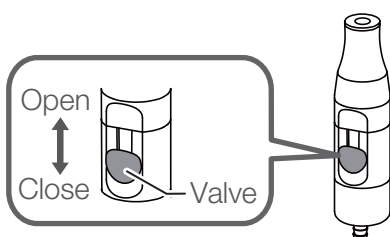

(6) BT06 Saliva ejector

Take the saliva ejector out of the assistant holder, and suction will start.

Since a delay circuit is provided, suction does not stop immediately when the saliva ejector is returned to the assistant holder.

In case of the central suction system, It will continue for approx. 4 seconds.

The suction volume may be controlled by opening or closing the valve.

* Use the disposable saliva ejector tip.

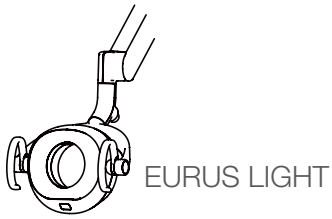

(7) dental light

Before use, always read the Instructions for dental light to ensure correct usage.

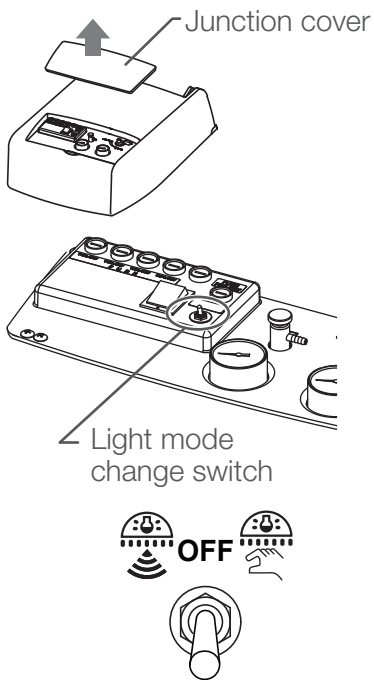

(8) Dental light mode selection switch

Remove the junction cover.

The Dental light mode selection switch can be changed between sensor mode and manual mode.

Indication	Mode	Condition
	Sensor mode	Turning the dental light on or off with the touchless switch.
	Manual mode	The dental light is continuously turned on at the maximum illuminance. * The light cannot be turned on/off with the touchless switch of the dental light.
OFF	OFF mode	The dental light is continuously turned off.

(9) Monitor bracket

the PC monitor can be mounted on this bracket.

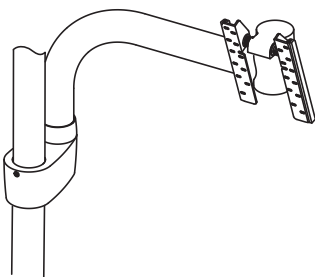

CAUTION

Do not apply an excessive load or shock to the monitor or monitor bracket. To avoid damage or injury, ensure that the monitor satisfies the following specifications:

Weight: 4 kg

5-6 Right/Left handed dentistry conversion

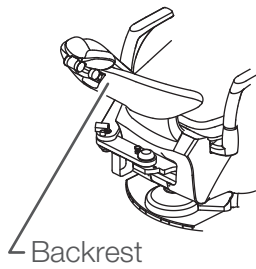

Doctor control panel

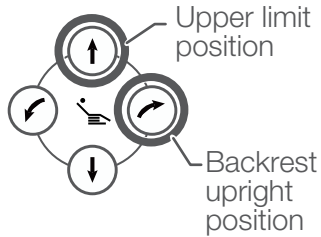

CAUTION

Take care so the unit does not make contact with other people or obstacles during the conversion. It may cause damage to the unit or physical injury.

Read the "2 Safety Precautions (14 page) Precautions concerning the foot controller position" thoroughly before conducting the procedure.

Right/Left handed dentistry conversion

Example : Convert from right handed position to left handed position

1) Swing the doctor unit behind the chair.

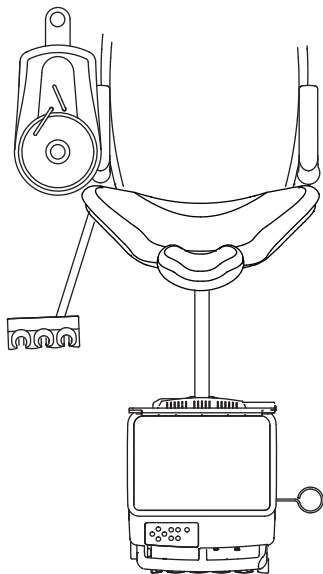

2) Pull up the lock pin to free the cuspidor arm.

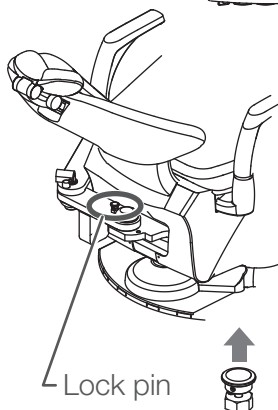

5 Operation

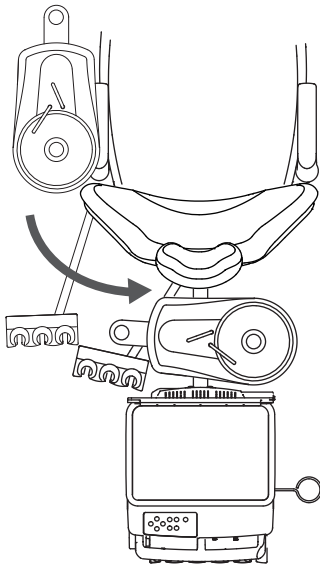

- 3) Swing the cuspidor unit and assistant holder behind the chair.

CAUTION

Take care so the cuspidor unit does not hit the doctor table during the conversion.

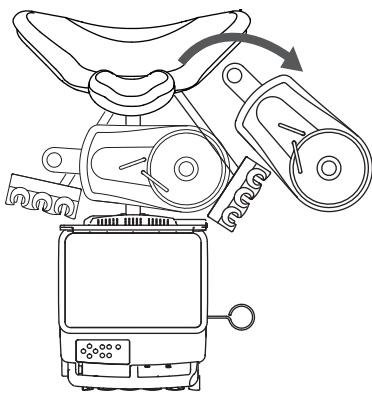

- 4) While moving the cuspidor unit from the rear to the right side, turn it clockwise.

- 5) Remove the assistant holder from assistant arm. Switch the position of the assistant holder to the other side. After the procedure, if the HVE/SE hose and syringe hose are twisted, unwind it before placing it in the assistant holder.

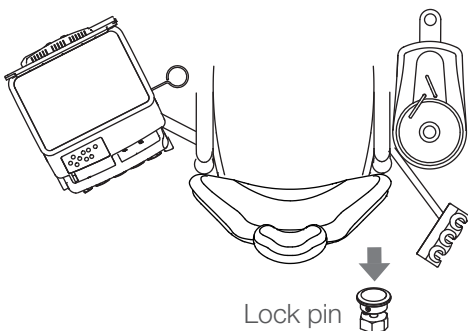

- 6) Move the cuspidor unit and assistant holder to the position shown in the left figure, and push down the lock pin to lock the cuspidor arm.

- 7) Move the doctor table from the rear to the left side.

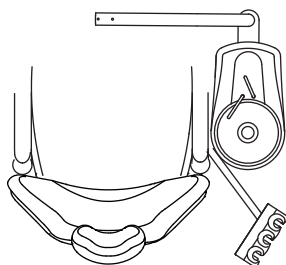

- 8) Move the dental light to the other side.

Confirm the safety functions

For safe use of this product, please confirm the safety functions as follows after every conversion.

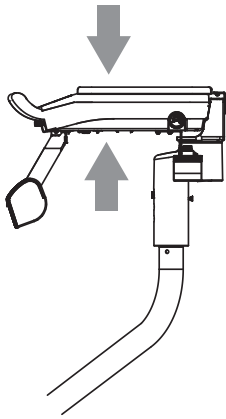

When excess pressure (upward or downward) is applied to the doctor table.

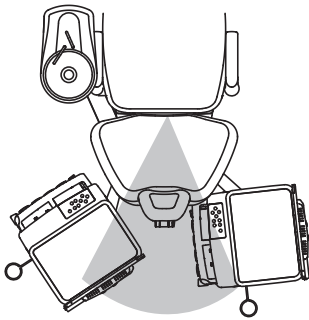

When the doctor table is turned to the back side of the backrest.

6 Chair lock function

When the lock function is activated, the chair movement is stopped.
The functions that become locked and the unlocking steps are as follows.

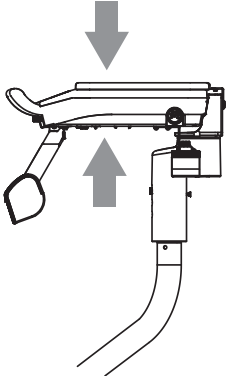
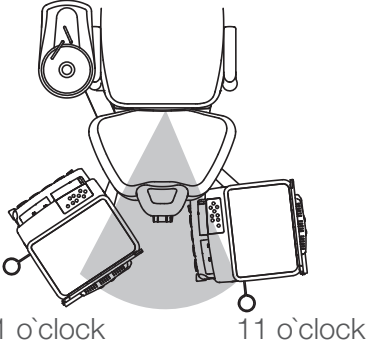
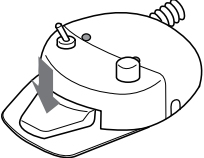
<p style="text-align: center;">Condition 1</p> <p>When the force is applied to the doctor table from the upward/downward direction during the automatic operation of the chair</p> 	<p style="text-align: center;">How to unlock</p> <p>After resolving the condition of interference, confirm safety, and operate the chair.</p> <hr/> <p style="text-align: center;">Locked functions</p> <p>Automatic operations of the chair</p>
<p style="text-align: center;">Condition 2</p> <p>When the doctor table is turned to the back side of the backrest (11 o'clock~1 o'clock), during the automatic operation of the chair.</p>  <p style="text-align: center;">1 o'clock 11 o'clock</p>	<p style="text-align: center;">How to unlock</p> <p>Turn the doctor table from the back side of the backrest (11 o'clock~1 o'clock).</p> <hr/> <p style="text-align: center;">Locked functions</p> <p>Automatic operations of the chair</p>
<p style="text-align: center;">Condition 3</p> <p>When the foot controller pedal is stepped on during the automatic operation of the chair</p> 	<p style="text-align: center;">How to unlock</p> <p>Step off the pedal, check safety, and operate the chair.</p> <hr/> <p style="text-align: center;">Locked functions</p> <p>All chair operations</p>

7 Adjustment

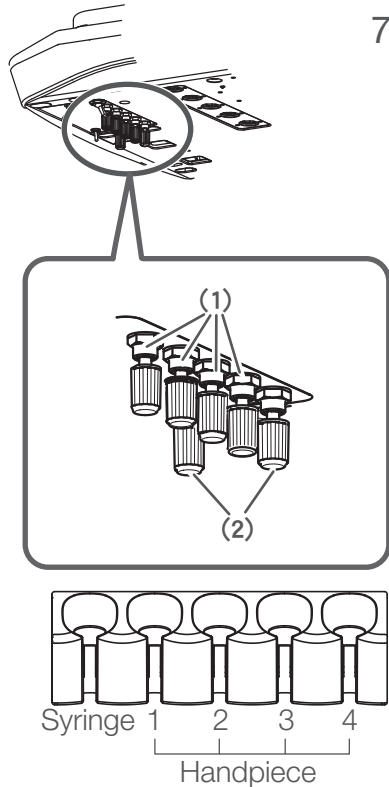

7-1 Doctor unit

(1) Adjusting the quantity of water supplied to the handpiece spray

The quantity of water supplied to the handpiece spray from the doctor unit can be adjusted with the knobs (1) (with blue caps).

(2) Adjusting the quantity of water /air supplied to the 3 way syringe spray

The quantity of water and air supplied from the doctor unit can be adjusted with the knobs (2).
 Blue cap: Quantity of water supplied
 Yellow cap: Quantity of air supplied

* Correspondence between a holder and its adjusting knob. (See the figure on the left)



All the knobs decrease the flow rate when turned clockwise and increase it when turned counterclockwise.

Do not close the adjusting knob too tightly. It is used to increase or decrease flow rate and is not a stop valve. Note that it will idle if you close it too tightly.

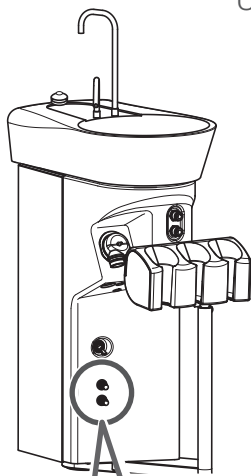

7-2 Cuspidor unit

Adjusting the quantity of water /air supplied to the 3 way syringe spray

The quantity of water and air supplied from the cuspidor unit can be adjusted with the knobs.

Blue cap (W marking): Quantity of water supplied

Yellow cap (A marking): Quantity of air supplied

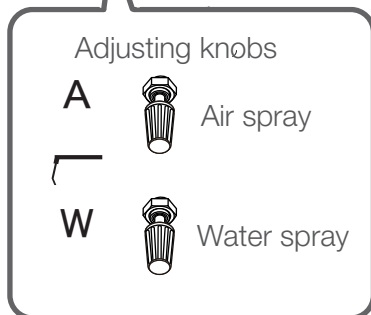

All the knobs decrease the flow rate when turned clockwise and increase it when turned counterclockwise.

Do not close the adjusting knob too tightly. It is used to increase or decrease flow rate and is not a stop valve. Note that it will idle if you close it too tightly.

8 Maintenance and Cleaning

8-1 Doctor unit

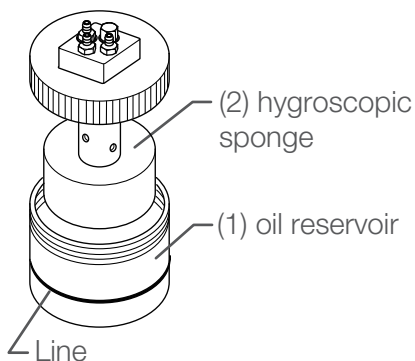
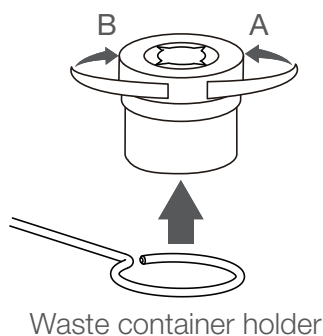
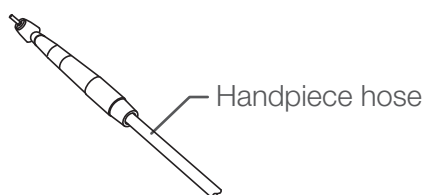
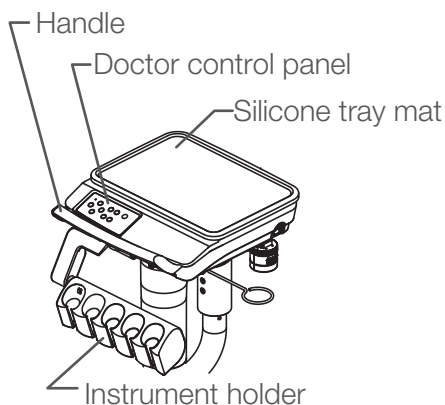

- (1) Instrument holder
- (2) Doctor control panel
- (3) Handle
- (4) Silicone tray mat
- (5) Handpiece hose

Wipe the surface with a soft cloth or paper towel moistened with FD366 manufactured by Dürr / PlastiSept eco Wipes FP manufactured by ALPRO, and then wipe it with a dry cloth.

If the exterior is excessively dirty, moisten a soft cloth with water containing approx. 10% neutral detergent, and wipe the exterior with the cloth. Then, wipe it with a cloth moistened with water and then dry it completely with a dry cloth.

Do not spray detergent directly onto the exterior. Clean the surface with a soft cloth or paper towel moistened with detergent, and wipe it with a dry cloth. If liquid enters the product, it may cause a malfunction or failure.

Cleaning of handpieces

Refer to the Instructions for Use for the respective handpieces.

- (6) Waste container

When the waste container becomes full, the stainless waste receptacle may be detached when it is turned in direction A.

It is fastened when turned in direction B.

The lid has sharp portions that can easily catch cotton, etc. Be very careful when cleaning it.

- (7) Oil mist separator

This unit collects oil from the exhaust air from the handpiece.

When oil reaches to the line on the oil reservoir (1), make sure you discard the oil.

Turn the oil reservoir counterclockwise to remove.

If the hygroscopic sponge (2) (consumable) is excessively dirty or has excessive oil on it, replace it.

Contact your local authorized Belmont dealer for a replacement for the hygroscopic sponge. (Replacement will be charged for.)

8-2 Cuspidor unit

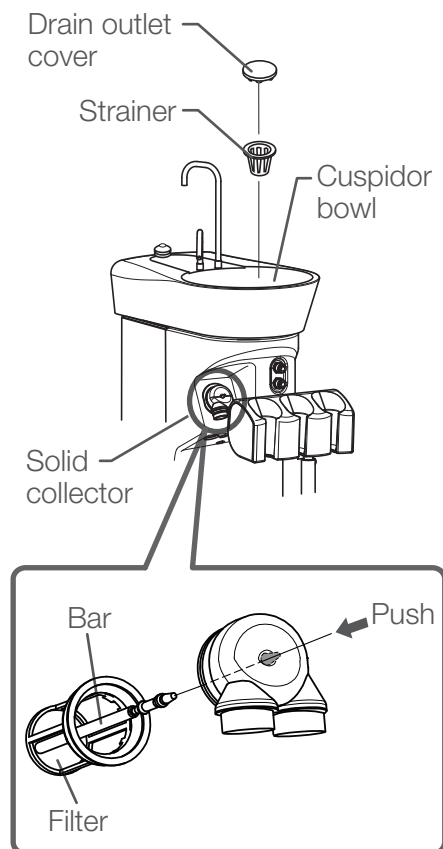
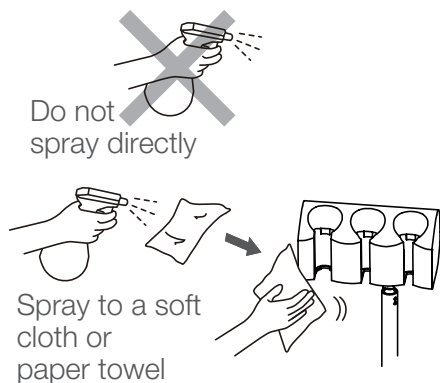

(1) Assistant holder

Wipe the surface with a soft cloth or paper towel moistened with FD366 manufactured by Dürr / PlastiSept eco Wipes FP manufactured by ALPRO, and then wipe it with a dry cloth.

If the exterior is excessively dirty, moisten a soft cloth with water containing approx. 10% neutral detergent, and wipe the exterior with the cloth. Then, wipe it with a cloth moistened with water and then dry it completely with a dry cloth.

Do not spray detergent directly onto the exterior. Clean the surface with a soft cloth or paper towel moistened with detergent, and wipe it with a dry cloth. If liquid enters the product, it may cause a malfunction or failure.

(2) Strainer

Since the strainer easily gets clogged, detach the drain outlet cover and clean the filter after consulting hours every day.

(3) Solid collector

After consulting hours, remove the filter from the solid collector in the cuspidor unit, and wash it. Accumulated debris may degrade the suction force of the HVE or saliva ejector.

- 1) Pull out and detach the filter in the solid collector from cuspidor unit.
- 2) The filter can be removed from solid collector by pushing the bar from front side of the solid collector and clean with running water. Contact your local authorized Belmont dealer for a replacement for the filter. (Replacement will be charged for.)

Clean the filter with running water. Do not use brush to clean the filter which may damage to the filter.

(4) Cuspidor bowl

Use MD550 manufactured by Dürr to cleaning the cuspidor bowl.

CAUTION

- Never use sandpaper, metal scrub brushes or abrasive cleaning agents to clean the cuspidor bowl.
- Do not use strongly acidic cleaning agents or alkaline pipe cleaning agents, which may cause of metals, etc.
- Be careful not to apply unnecessary force to it when cleaning. (Be careful not to hit or drop it.)

8 Maintenance and Cleaning

(5) Suction line

Handpieces for HVE and saliva ejector suction the secretions, saliva, or blood that contains bacteria. Therefore, always wash and sterilize them using MD555/Orotol plus manufactured by Dürr after the procedure.

Use Orotol Plus for daily care. In addition, we recommend using MD555 for weekly cleaning.

Do not use any detergent except our designated one. Otherwise, strong acidic detergents or alkaline drain preparations may cause clog, damage, or metal corrosion.

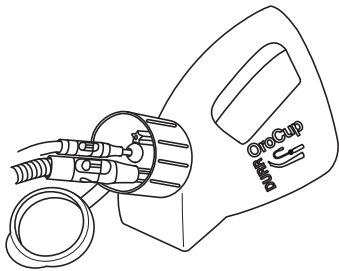

HVE

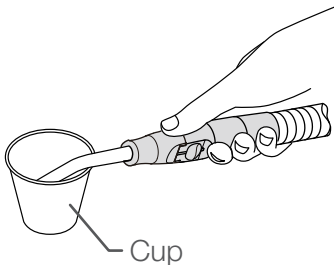

Saliva ejector

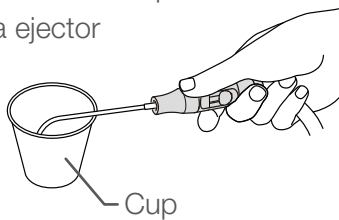

(6) HVE / Saliva ejector hose

Suction a cup of water (approx. 100 ml) or more into the HVE and saliva ejector after use by a patient. This is to clean and dilute the medicine used and to prevent the handpieces deteriorating.

Some medicines used for the procedure may cause deterioration of the handpiece. It may dissolve, deform, or damage part of the handpiece, possibly resulting in leaks from the handpiece or suction failure. This will ultimately makes the handpiece unusable. Please wash them properly to ensure long-term use.

(7) HVE hose / Saliva ejector hose

The HVE hose and saliva evacuation hose can be removed by holding the joint and pulling the hose. The exterior of the hose can be washed under tap water. To reattach the hose, insert the joint into the receptacle.

Always turn off the main switch before pulling the hose off to wash it.

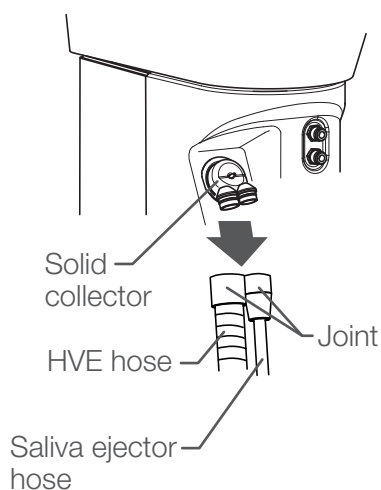

8-3 Washing and sterilizing the HVE and saliva ejector

(1) Disassembly

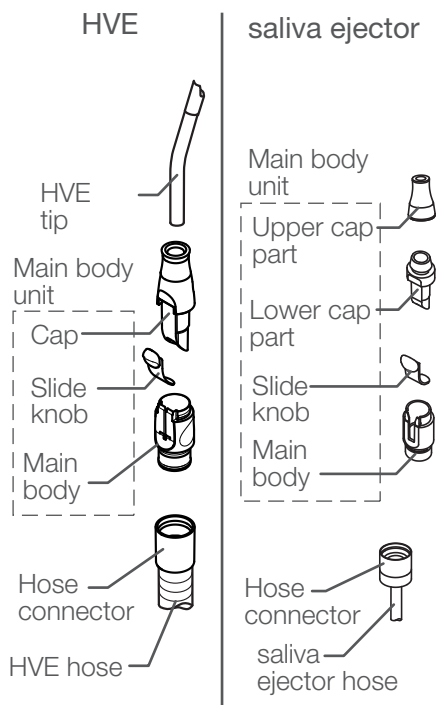

(2) Washing the surface

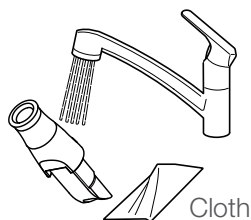

(3) Washing the interior and sliding part

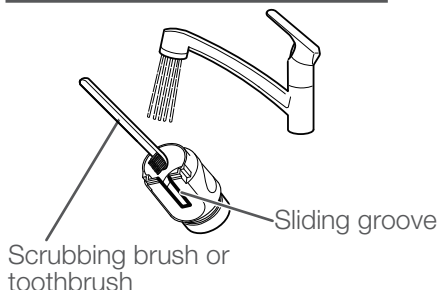

(4) Washing parts inaccessible with a brush

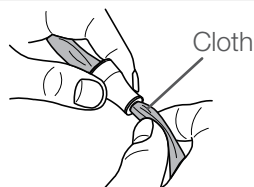

Wash and sterilize the handpieces between patients. To properly sterilize the HVE and saliva ejector, it is necessary to wash them to remove dirt and immerse them in detergent. Then, rinse them to remove any remaining detergent. Follow the procedure below to wash and sterilize the handpieces.

(1) Disassembly

To prepare for washing, disassemble the handpieces as shown in the figure.

Hold the hose connector, and pull the HVE hose and saliva ejector hose to detach them from the main body.

(2) Washing the surface

Rinse the surface with clean water (tap water) warmed to a temperature of $40 \pm 5^\circ\text{C}$, and rub it with a cloth to remove dirt. When all dirt is removed, wipe it dry.

(3) Washing the interior and sliding groove

Rinse the interior and sliding groove of the main body with clean water (tap water) warmed to a temperature of $40 \pm 5^\circ\text{C}$, and scrub them with a scrubbing brush or toothbrush. When all dirt is removed, wipe them dry.

(4) Washing parts inaccessible with a brush

If some parts are inaccessible with a brush, rub them with a cloth.

Rinse them well with clean water (tap water) warmed to a temperature of $40 \pm 5^\circ\text{C}$ (for at least 1 minute).

Immerse the parts in ID212 manufactured by Dürr or alkaline cleaner for 5 minutes.

Then, rinse them well with clean water (tap water) warmed to a temperature of $40 \pm 5^\circ\text{C}$ (for at least 1 minute).

Inspect the parts for any visible dirt. If any visible dirt remains, repeat the above washing process.

Wash them immediately after use.

If the parts are in the condition described below after washing, do not autoclave them. Replace them.

A hole/holes are clogged, and dirt cannot be removed.

8 Maintenance and Cleaning

Caution when assembling HVE before sterilization

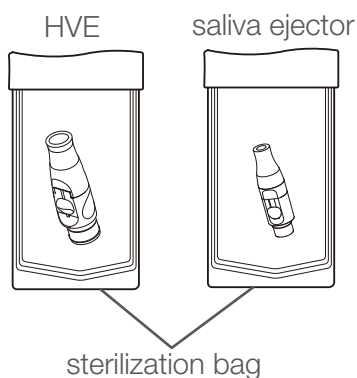
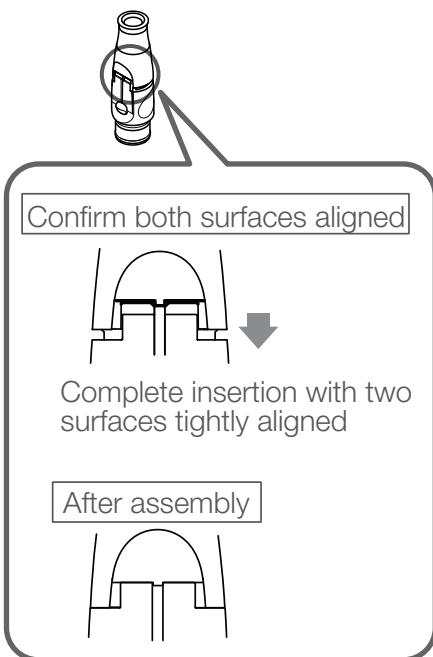
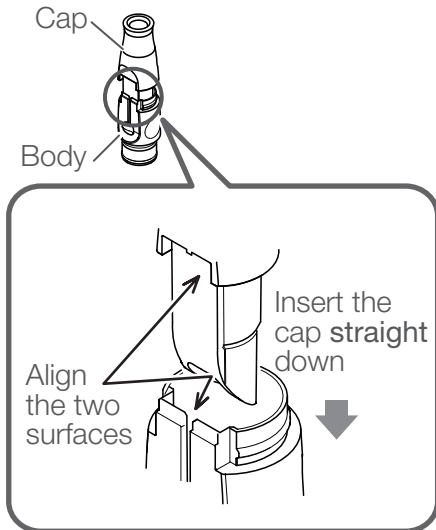

(5) Sterilization

The HVE and saliva ejector are autoclavable. Reassemble the main body unit, and autoclave the HVE and saliva ejector.

When assembling the HVE, align the two surfaces; a flat surface of the cap and the surface of the sliding groove of the body. Then, slide the cap into the body straight.
* Do not insert it twisted.

1. Put the handpiece in a sterilization bag, and seal the opening.
2. Autoclave it at a temperature of 134°C for 3 minutes.

The handpieces can be autoclaved up to 250 times. Storage method: After sterilization, store the handpiece in the sterilization bag in a dark, cool place.

⚠ CAUTION

- Sterilization must be done every after use to patients.
- Sterilization by class B cycles.
- The temperature of autoclave sterilizer must be at 135°C or less, not exceeding 135°C.
- Dry naturally if the temperature for drying process is to exceed 135°C.
- After autoclave sterilization, the cap, filter, body and valve are subject to discoloration, which does not have a negative effect on performance.
- The slide knob can be autoclave 100 times and is expendable supplies.
- If damage occurs to the sterilization bag, discard and sterilize again using a new sterilization bag.

8-4 Washing and sterilizing the 3WAY syringe

Wash and sterilize the handpieces between patients. To properly sterilize the 3way syringe, it is necessary to wash them to remove dirt and immerse them in detergent. Then, rinse them to remove any remaining detergent. Follow the procedure below to wash and sterilize the handpieces.

SYR-20

(1) Disassembly

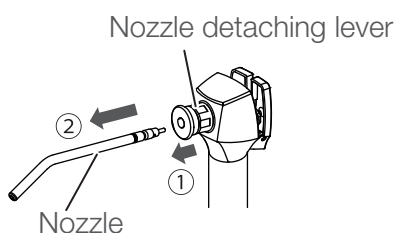

(2) Cleaning

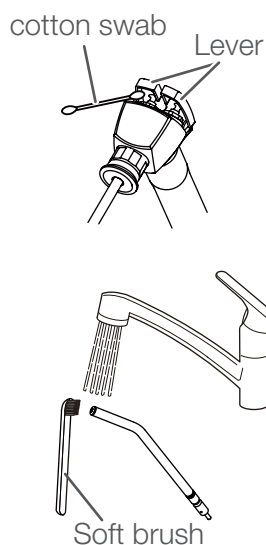

SYR-20

(1) Disassembly

To prepare for washing, disassemble the nozzle as shown in the figure.

Pull ① the nozzle detaching lever to unlock the nozzle, then ② the nozzle is detachable.

(2) Cleaning

Cleaning inside of the lever.

If dust or dirt accumulates inside the lever, use a cotton swab to remove them.

[Ultrasonic bath]

Clean nozzle under running water for 30 seconds with a soft brush and place in an ultrasonic bath with an enzymatic cleaner to remove superficial debris prior to sterilization. If debris remains, the nozzle will not be properly sterilized.

[Other than Ultrasonic bath]

1. Wipe off the surface contamination by a cloth while rinsing the surface by running clean warm water at 40 ± 5 degrees. Scrub the tip and joint part of nozzle by a cleaning brush or by a tooth brush with running clean warm water at 40 ± 5 degrees.
2. Check whether contamination is removed or not after cleaning. Continue the cleaning if contamination is remained.
3. Immersed with an alkaline disinfection or detergent for 5 minutes. (We recommend to use ID212 made by DURR)
4. Rinse thoroughly by distilled water at ordinary temperature or by clean water for more than 1 minute.

Wash them immediately after use.

If chemicals or foreign substances adhere to the nozzle, failure may result or discoloration may occur. Therefore, cleaning and washing must be done before autoclave sterilization.

If the dirt cannot be removed, replace the nozzles.

8 Maintenance and Cleaning

(3) Sterilization



(3) Sterilization

Insert the nozzle in a sterilization bag and seal it. Choose the appropriate method from the following sterilization cycles depending on the type of the autoclave sterilizer in your clinic:

[Dynamic-Air-Removal]

Autoclave it at a temperature of 134°C for 3 minutes with a 15-minute drying time.

[Gravity displacement]

Autoclave it at a temperature of 132°C for 15 minutes with a 30-minute drying time.

⚠ CAUTION

If damage occurs to the sterilization pouch, discard and sterilize again using a sterilization bag.

The nozzle can be autoclaved up to 250 times.

Do not sterilize the nozzle except for autoclave sterilization. Autoclave sterilizer in compliance with Class B is recommended.

The temperature of autoclave sterilizer must be at 135°C or less, not exceeding 135°C.

Dry naturally if the temperature for drying process is to exceed 135°C.

Storage method: After sterilization, place the nozzle in the sterilization pouch, and store it in a dry, dark, cool place.

(4) Attaching the nozzle

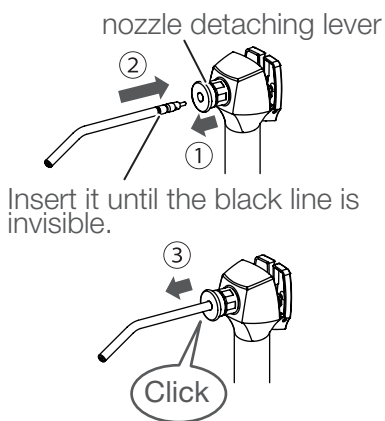

Example of attaching nozzle

Good example

Black line on the nozzle is invisible.

There is no gap between the inner part and outer ring of the nozzle detaching lever

No gap

Bad example

Black line on the nozzle is visible.

There is a gap between the inner part and outer ring of the nozzle detaching lever

gap

(4) Attaching the nozzle

1. Pull ① the nozzle detaching lever and insert the nozzle until ② the black line is invisible shown in the left figure.
2. Release the nozzle detaching lever and ③ pull the nozzle a little. It clicks and locked.
3. After the nozzle is attached, confirm that the nozzle cannot be detached when pulling it.

Follow the example of attaching nozzle shown in the figure, and check the nozzle is securely attached.

⚠ WARNING

If SYR-20 3way syringe is used with its nozzle not securely attached, it may burst out when spraying water or air, and may harm users or other people.

Confirm that the nozzle is securely attached before its use.

BT14

BT14

(1) Cleaning inside the nozzle

Insert the accompanied nozzle cleaning tool from the tip of the nozzle. Clean the inside of the nozzle and remove the residues by spraying water and air.

If the nozzle is autoclaved with residues remained, the residues are clogged inside the nozzle, and water may not come out.

CAUTION

- For cleaning, do not insert the interdental toothbrush or the like into the nozzle inserting port while the nozzle is detached.
- O-ring (seal material) is attached inside the nozzle inserting port. If it's damaged, water leak may occur.

(2) Disassembly

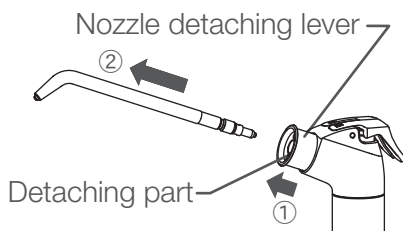

(2) Disassembly

To prepare for washing, disassemble the nozzle as shown in the figure.

Pull ① the nozzle detaching lever to unlock the nozzle, ② then the nozzle is detachable.

(3) Cleaning

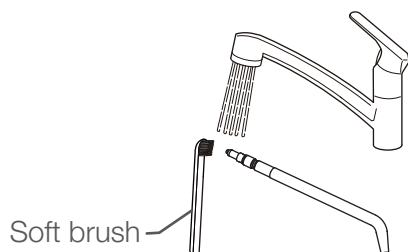

(3) Cleaning

1. Wash the nozzle carefully under running water. Run the water through inside the nozzle.
2. Immerse the nozzle in the disinfectant ID212 manufactured by Dürr diluted with water about 25 times, and perform ultrasonic cleaning for 10 minutes or more. Immerse the inside surface of the nozzle to the solution.
3. After the ultrasonic cleaning, wash the nozzle carefully under running water again. Run the water through inside the nozzle.

Wash them immediately after use.

If chemicals or foreign substances adhere to the nozzle, failure may result or discoloration may occur. Therefore, cleaning and washing must be done before autoclave sterilization.

If the parts are in the condition described below after washing, do not autoclave them. Replace them.

8 Maintenance and Cleaning

(4) Sterilization



(4) Sterilization

1. Insert the handpiece in a sterilization bag and seal it.
2. Autoclave them at a temperature of 135°C for 3 minutes.

The handpieces can be autoclaved up to 250 times.
Storage method: After sterilization, place the nozzle in the sterilization pouch, and store it in a dry, dark, cool place.

CAUTION

- Sterilization must be done every after use to patients.
- Sterilization by class B cycles.
- The temperature of autoclave sterilizer must be at 135°C or less, not exceeding 135°C.
- Dry naturally if the temperature for drying process is to exceed 135°C.
- If damage occurs to the sterilization bag, discard and sterilize again using a new sterilization bag.

(5) Attaching the nozzle

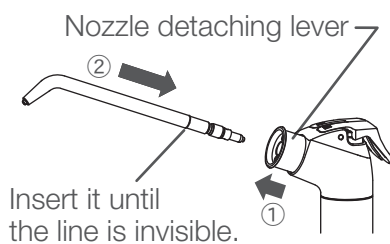

(5) Attaching the nozzle

- 1) Pull ① the nozzle detaching lever and insert the nozzle until ② the line is invisible shown in the left figure.
- 2) Release the nozzle detaching lever and pull the nozzle a little. It clicks and locked.
- 3) After the nozzle is attached, confirm that the nozzle cannot be detached when pulling it.
Follow the example of attaching nozzle shown in the left figure, and check the nozzle is securely attached.

Example of attaching nozzle

Good example

Nozzle detaching lever is returned.
*Nozzle detaching lever and detaching part are on the same plane

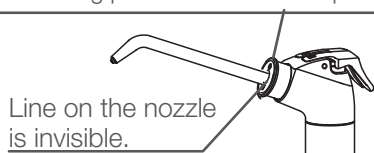

Bad example

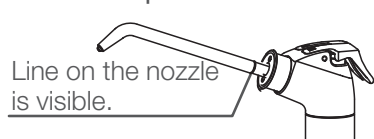

WARNING

If BT14 is used with its nozzle not securely attached, it may burst out when spraying water or air, and may harm users or other people.

Confirm that the nozzle is securely attached before its use.

8 Maintenance and Cleaning

(6) Applying vaseline to the nozzle

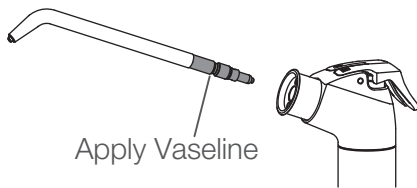

(6) Applying vaseline to the nozzle

Repeated detachment of the nozzle decreases the amount of grease for O-ring, which may stiffen the operation of detachment.

If the operation of detaching nozzle stiffens, apply a little of vaseline on the surface of nozzle inserting part shown in the left figure.

(7) Flushing

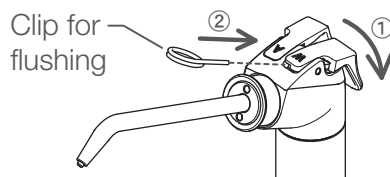

After attaching the clip

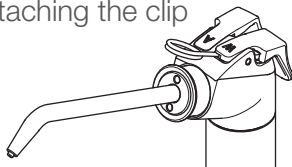

(7) Flushing

When flushing the retained water, accompanied clip for flushing (hereinafter, 'clip') is used for keeping water discharging.

When inserting the BT14 syringe inside the built-in flushing sleeve, the clip is not needed.

[Method to use]

1. Direct the nozzle toward the cuspidor bowl, and press the W lever and discharge water. (①)
2. While discharging water, insert the clip between the body and lever as shown in the left figure (②) to keep the W lever pressed.
3. Also perform the flushing for other handpieces equipped with the unit.
4. After flushing, remove the clip by pressing the W lever, and return the syringe to the instrument holder.
Keep the clip safe not to lose it.



CAUTION

Be careful not to injure yourself when using the clip for flushing because the tip of them are sharp.

8 Maintenance and Cleaning

8-5 Junction unit

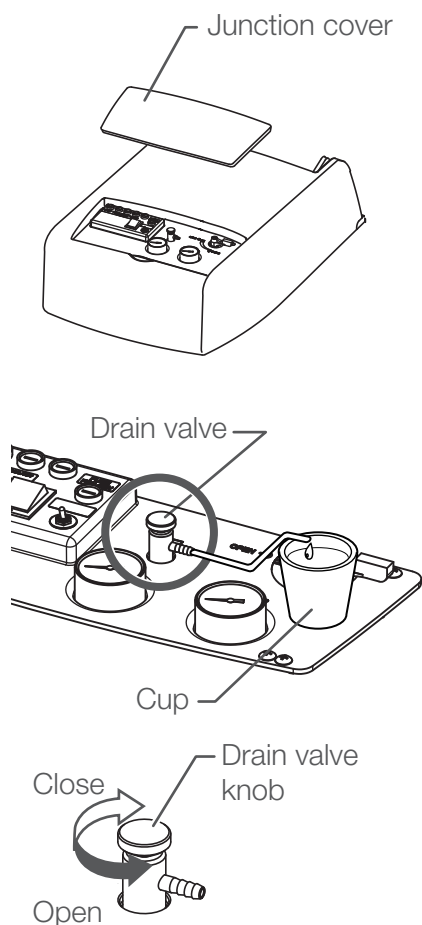

(1) Air filter

Empty any water that has collected in the air filter at least once a week.

1. Remove the junction cover.
2. Prepare a cup to put the water in.
3. Turn the drain valve knob counterclockwise, and discharge the water into the cup.
4. When no more water comes out, turn the drain valve knob clockwise to close it.

After closing the drain valve knob, water remained in the tube may come out.

Wipe the water with cloth to prevent the water from coming out.

If any water gets into the air line, it may cause a failure of the product.

(2) Air compressor

For maintenance of the air compressor, follow the Instructions for Use supplied with the air compressor.

(3) Vacuum pump

For maintenance of the vacuum pump, follow the Instructions for Use supplied with the vacuum pump.

8-6 Exterior

To clean and disinfect the exterior of the product, wipe the surface with a soft cloth or paper towel moistened with FD366 manufactured by Dürr / PlastiSept eco Wipes FP manufactured by ALPRO, and then wipe it with a dry cloth.



CAUTION

- If the exterior is excessively dirty, moisten a soft cloth with water containing approx. 10% of neutral detergent, and wipe the exterior with the cloth. Then, wipe it with a cloth moistened with water and dry it completely with a dry cloth.
- Never use any of the products listed below:
Volatile chemicals such as paint thinner, butanol, isopropyl alcohol, nail-varnish remover, gasoline, or kerosene; acid, alkaline or chlorine detergents; highly corrosive disinfectants (povidone-iodine such as Isodine, sodium hypochlorite, etc.); abrasive polishing wax or abrasive sponge.
- If water or detergent is left on the surface, wipe it off immediately. Moisture or detergent may cause rust or failure of electrical parts.

8 Maintenance and Cleaning

8-7 Maintenance and inspection

Notes on daily maintenance and inspection (by the user)

It is the responsibility of the user (medical institution) to ensure that the medical device is correctly maintained and inspected. To ensure safe use of this product, the unit must be inspected at the specified intervals as described in the table below:

No	Inspection item	Inspection	Inspection procedure and criteria	Outcome if inspection is not conducted	Maintenance required when the inspection criterion is not satisfied
1	Check the cancel function	Before consulting hours	When the chair is in automatic operation, it must stop when any of the operation switches shown on [Page 35] is pressed or foot controller pedal stepped on.	The chair unexpectedly moves during procedure, resulting in an injury. The patients may be caught between the doctor unit and the chair, resulting in an accident.	If the chair does not stop, please contact your local authorized Belmont dealer.
2	Check for water, air and oil leaks	Before consulting hours	Check that no water, air or oil leaks out from the product.	The product does not function properly, preventing proper treatment or procedure.	If water, air or oil leaks out, please contact your local authorized Belmont dealer.
3	Check the functioning of each handpiece	Before consulting hours	<ul style="list-style-type: none"> • Check that the turbine rotates properly and that the correct quantities of water and air are supplied. • Check that the micromotor rotates properly and that the correct quantity of water is supplied. • Check that the ultrasonic scaler vibrates properly and that the correct quantity of water is supplied. • Check that the correct quantities of water and air are supplied from syringe. 	The patient may receive an injury to their mouth, or the handpiece may malfunction.	Adjust the quantity of water or air. [Page47] For other failures, please refer to the Instructions for Use for the respective handpieces. If the problem still persists, please contact your local authorized Belmont dealer.
4	Check the correct burr for the turbine, air motor, and micromotor is mounted.	Before each patient	Check that the correct burr is securely mounted. Make sure you refer to the Instructions for Use for the turbine, air motor and micromotor. Check that the burr is free of any defect (damage or deformation).	The burr will not rotate freely, resulting in an accident.	If the burr is damaged, deformed or has some other defect, replace the burr by following the Instructions for Use for the turbine, air motor and micromotor.
5	Check the scaler tip	Before each patient	Check that the correct tip is securely mounted and properly used. Refer to the Instructions for Use for the scaler. Check that the tip is free from any defect (wear or deformation).	The tip will not vibrate properly, resulting in an accident.	If the tip is worn or deformed, replace it by following the Instructions for Use for the scaler. For other defects, please contact your local authorized Belmont dealer.
6	Debris in the micromotor	After consulting hours	Check that no excess oil from the handpiece adheres to the motor unit.	The motor unit may not function properly, resulting in a malfunction.	Follow the Instructions for Use for the micromotor to maintain it.
7	Maintenance HVE / Saliva ejector	After consulting hours	Wash the suction lines	Suction is defective.	Wash the suction lines. [Page 50]

8 Maintenance and Cleaning

No	Inspection item	Inspection	Inspection procedure and criteria	Outcome if inspection is not conducted	Maintenance required when the inspection criterion is not satisfied
8	Check the functioning of lever (syringe)	Before consulting hours	Water, air, and spray come out by pressing A lever and W lever. No wobbliness is observed when pressing the lever.	The product does not function properly, preventing proper treatment or procedure.	Contact your local authorized Belmont dealer.
9	Check for the lock of the nozzle (BT14 syringe)	Before each patient	Check that the nozzle is securely locked. Check that the locked nozzle does not detach when pulling it.	The nozzle may burst out and harm users or other people.	Securely lock the nozzle. [Page 56] When any malfunction is observed, please contact your local authorized Belmont dealer.
10	Maintenance Cuspidor bowl	After consulting hours	Check that the cuspidor bowl does not contain any dirt (or excrescence). Check that no dirt has collected on the dirt filter.	Draining is defective.	Clean the cuspidor bowl and dirt filter. [Page 49]
11	Maintenance Solid collector	After consulting hours	Check that no dirt has collected on the solid collector.	Suction power of the HVE or saliva ejector has decreased.	Clean the filter. [Page 49]
12	Maintenance Exterior	After consulting hours	Check that no chemical solution or dirty water adheres to or remains on the exterior of the product.	Any liquid remaining will cause discoloration or change the properties of the exterior or cause metal parts to rust.	Clean it. [Page 58]
13	Check the main switch and main water valve	After consulting hours	Check that the main switch is turned off, and the main water valve is closed .	May result in a short circuit or water leaks.	If the main switch cannot be turned off or the main water valve cannot be closed, please contact your local authorized Belmont dealer.
14	Movable parts of the product	Once a week	When operating the product, check that no movable parts emit any abnormal noise.	The product does not function properly, preventing proper treatment or procedure.	If any movable parts emit an abnormal noise, please contact your local authorized Belmont dealer.
15	Maintenance Drain valve	Once a week	Drain water from the drain valve on the air filter.	Water enters the air line, resulting in a malfunction.	Always drain the air filter. [Page 58]
16	Check water and pneumatic pressures	Once a month	Check the water and pneumatic pressures using the pressure gauge on the maintenance panel. Main water pressure : 0.2MPa Main air pressure : 0.5MPa	The product does not function properly, preventing proper treatment or procedure.	If the pressure is out of the range of the main water pressure/main air pressure, please contact your local authorized Belmont dealer.
17	Check the doctor unit	Once a month	The doctor table is level and stops at the specified position.	Objects fall from the doctor table, resulting in an injury or accident.	If the doctor table is not level or does not stop at the specified position, please contact your local authorized Belmont dealer.
18	Oil mist separator	Once a month	The drain oil does not reach the line on the oil mist separator.	The handpiece may not function properly due to an exhaust failure.	Empty the oil. [Page 48]



WARNING

Always refer to this Guide and the Instructions for Use supplied with each device (such as the dental light and handpieces) before conducting daily maintenance and inspection.

If you do not conduct daily maintenance or inspection, use of the product may result in injury or damage to nearby devices.

Notes for periodic inspection

The product contains parts that stop functioning or wear depending on the use frequency, and therefore it is important to carry out maintenance in a periodic inspection once a year (including replacement of consumables) and safety checks. Service parts required for the periodic inspection (including consumables) are listed in the table below.

However, depending on the specifications of your device, there may be alternative parts available that differ from those listed in the table below.

Maintenance and inspection can be outsourced to qualified persons such as authorized repairers of medical devices. If you have any question about periodic inspection, contact your local authorized Belmont dealer.

List of service parts required for the periodic inspection

Part name	Standard service life	Part name	Standard service life
Movable part	7 years	Switch	5 years
Wire for a movable part	5 years	PC board	5 years

List of consumables required for periodic inspection

Part name
O-ring
Packing
Diaphragm
Various filters



WARNING

Always entrust periodic inspection to your local authorized Belmont dealer.

If you do not carry out periodic inspection, use of the product may cause injury or damage to nearby devices.

8-8 Detachable parts

Part name	Part name
Handpiece	HVE tip
Handpiece hose	Syringe nozzle
Drain outlet cover	HVE
Cuspidor bowl strainer	Saliva ejector
Solid collector	Water service coupler
Solid collector filter	Air service coupler
Oil mist separator	

8-9 Storage method

If the product is not used for an extended period of time after consulting hours or during holidays, make sure you observe the precautions below:

1. Always turn off the main switch after consulting hours.
(This is to stop supply of air, water, and electric power.)
Make it a habit to do this to prevent water leak and electrical accidents.
2. After consulting hours, turn the water main valve knob counterclockwise to the vertical position to close the water main valve. Make it a habit to do this to prevent accidents by water leaks.
3. Turn off the breaker for the compressor, and discharge air.
(Also make sure you have turned off the power.)
4. Turn off the breaker for the vacuum pump.
(Also make sure you have turned off the power.)
5. Turn off the breaker for the device in the clinic.
(Also make sure you have turned off the power.)
6. Set the chair to the lowest position and the backrest to the most reclined position.

9-1 After-sales service

When you request for repair

Refer to 'Troubleshooting' before you check the device. If the problem persists, turn off the main switch, and contact your local authorized Belmont dealer to request a repair.

9-2 Service life

The service life of this product is 10 years on condition that maintenance and inspection are properly conducted [according to our self-certification (our data)].

However, the standard service lives of service parts that require periodic inspection vary according to the part. [Page 61]

9-3 Period of Parts Retention

We hold service parts such as consumables for products for 10 years from the time of launch.

* Service parts are parts required for repair to return the product to the original state and functions or to maintain its functions.

10 Troubleshooting

If you encounter any of the problems listed below, take the countermeasures described below before requesting a repair. If the problem persists even after troubleshooting, stop using the product immediately, turn off the main switch, and contact your local authorized Belmont dealer.

Phenomenon	Please check	Remedy
The product does not work at all.	Is the main switch turned on?	Turn on the main switch. [Page 29]
	Is the power to the compressor turned on?	Turn on the power.
	Is the breaker for the device on the switch-board of the dentist's office turned on?	Turn on the breaker for the device.
No air is being supplied.	Is the power to the compressor turned on?	Turn on the power.
	Is the knob that controls the air supply to the syringe or other parts closed?	Open the air supply control knob. [Page 47]
No water is being supplied.	Is the water main valve closed?	Open the main water valve. [Page 29]
	Is the water supply control knob to the handpiece or syringe closed?	Open the water supply control knob. [Page 47]
The HVE or saliva ejector does not activate the suction function.	Is the power to the vacuum pump turned on?	Turn on the power.
	Is the solid collector filter dirty?	Clean the filter. [Page 49]
	Is the solid collector filter properly attached?	Attach the solid collector properly. [Page 49]

11 Consumables

Consumables are parts that will normally wear or deteriorate, change their appearance, or become damaged after use. Please note that repair or replacement of consumables are not covered by the warranty and will be charged for.

(* Degree of wear, deterioration or damage and timing for replacement depends on the use environment and conditions at the customer's premises.)

Consumables (Parts listed below are out of the guarantee coverage and charged parts.)

[Reference] List of service parts required for the periodic inspection.



TAKARA COMPANY EUROPE GmbH

Berner Strasse 18, 60437
Frankfurt am Main, Germany
TEL : +49-69-506878-0
FAX : +49-69-506878-20



 **Belmont**

TAKARA BELMONT CORPORATION

 2-1-1, Higashishinsaibashi, Chuo-ku, Osaka, 542-0083, Japan
TEL : +81-6-6213-5945
FAX : +81-6-6212-3680