

DENTAL X-RAY

PHOT-XIS

505

OPERATOR'S INSTRUCTIONS

- *Wall Mount Type* WK
- *Floor Mount Type* FK1/FK2
- *Mobile Type* FM
- *Room Mount Type* RK
- *Ceiling Mount Type* CK



⚠ WARNING

This X-ray equipment may be dangerous to patient and operator unless safe exposure factors, operating instructions and maintenance schedules are observed.

 **Belmont[®]**

INDEX

[1] INTRODUCTION.....	1
[2] MAJOR COMPONENTS.....	3
[3] FUNCTION OF CONTROLS	6
[4] OPERATING PROCEDURES	9
[5] ESTIMATED AIR KERMA	9
[6] OPTIONAL HAND EXPOSURE SWITCH.....	9
[7] DIGITAL IMAGING SYSTEM	10
[8] INFECTION CONTROL AND CLEANING	10
[9] ERROR CODES	11
[10] MAINTENANCE.....	12
[11] TECHNICAL DATA.....	14
[12] ELECTROMAGNETIC COMPATIBILITY (EMC)	16
[13] DISPOSAL	18
[14] LABEL LOCATION.....	19

[1] INTRODUCTION

1. GENERAL

This manual provides information for the operation and maintenance procedures and technical specifications for PHOT-X IIs 505 dental x-ray. The instructions contained in this book should be thoroughly read and understood before operation. PHOT-X IIs 505 has no user serviceable items. Repair should be performed by qualified dealer service personnel. Any part of this x-ray unit shall not be maintained or serviced while in use with a patient.

2. INTENDED USE OF THE PRODUCT

PHOT-X IIs 505 is an extraoral source dental radiographic x-ray unit. This unit is an active device intended to generate and control diagnostic purpose ionizing radiation. The absorption pattern of x-ray beam recorded on introral image receptor is used for general-purpose, routine, dental radiography examinations of diseases of the teeth, jaw and oral cavity structures.

3. PARTS IDENTIFICATION OF X-RAY SYSTEM "PHOT-X IIs 505"

- a. Tube housing assembly : 505-H
- b. X-ray controls : 505-CM (main controller), 505-CS (sub controller)
- c. Cones : 505-R (regular), 505-L (long)
- d. Collimator : 505-REC (rectangular)
- e. Balance arm : 505-A

4. DECLARATION OF CONFORMITY

We declare PHOT-X IIs 505 x-ray unit complies with following regulation and directive.

MDR (Medical Device Regulation) : Regulation (EU) 2017/745 Annex II and III

RoHS Directive : 2011/65/EU category 8 of Annex I

5. CLASSIFICATION

5-1. According to Medical Device Regulation, PHOT-X IIs 505 is classified as CLASS IIb medical device by the rule 10 of MDR ANNEX VIII.

5-2. According to IEC60601-1, PHOT-X IIs 505 is classified as follows.









































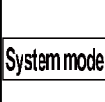

- a. Protection against electric shock : Class I Equipment
- b. Type of applied parts : Type B (RK type only)
- c. Protection against ingress of water : Ordinary
- d. Mode of operation : Non continuous (Duty Cycle = 1:30,
Max. ON time: 2.0 sec, Min. OFF time: 12 sec.)
- e. Equipment not suitable for use in the presence of a flammable anesthetic mixture with air or with oxygen or nitrous oxide.

6. NOTICE TO THE USER

- a. This X-ray unit may be dangerous to patient and operator unless safe exposure factors, operating instructions and maintenance schedules are observed.
- b. Only qualified and authorized personnel may operate this equipment observing all laws and regulations concerning protection. The operator must:
 - have means for audio and visual communication with the patient.
 - have full view of kV, mA, timer selections and exposure warning light.
 - be at least 2 m away from the x-ray head and patient and out of the path of the x-ray beam or be positioned behind a protective device.
 - fully use all radiation protection devices, accessories and procedures available to protect the patient and operator from x-ray radiation.
- c. Any serious incident occurred in relation to the device should be reported to the manufacturer and the competent authority of the Member State in which the user is established.

7. SYMBOLS

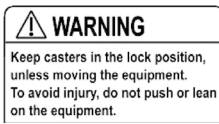
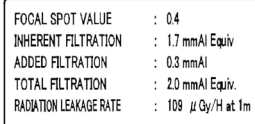
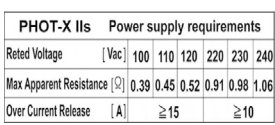
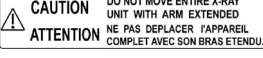
In this book, on the labels or on the control panel of PHOT-X IIs 505, following symbols are used. Confirm the meanings of each symbol by the table below.

	Follow Instructions for use		Protection against electric shock: Type B		ON (POWER)		OFF (POWER)
	Protection Grounding		Exposure Switch		X-ray Emission		Ready
	Upper Incisor		Upper Cuspid & Pre Molar		Upper Molar		Occlusal
	Lower Incisor		Lower Cuspid & Pre Molar		Lower Molar & Bite Wing		Bite Wing
	Digital Imaging		Patient Child		Patient Adult		Patient Large Adult
	Regular Cone		Long Cone		Authorized Representative in The European Community		Manufacturer
	Non-ionizing Radiation		Date of Manufacture		Serial Number		Catalogue Number
	Separate Collection for Electrical and Electronic Equipment		Compliance with European directive required		Model name of the whole unit as a medical device		Type of the device
	Identification for each component		Rated input to the device		Rated output from the device		Medical device
	Product of Japan		Brand symbol of Takara Belmont group		Weight of whole unit		Max. ON time: 2 second, Min. OFF time: 12 second
	WARNING Keep casters in the lock position, unless moving the equipment. To avoid injury, do not push or lean on the equipment.	WARNING Keep casters in the lock position, unless moving the equipment. To avoid injury, do not push or lean on the equipment.					FOCAL SPOT VALUE INHERENT FILTRATION ADDED FILTRATION TOTAL FILTRATION FILTRATION RADIATION LEAKAGE RATE
	PHOT-X IIs Power supply requirements Rated Voltage [Vac] 100 110 120 220 230 240 Max Apparent Resistance [Ω] 0.39 0.45 0.52 0.91 0.98 1.06 Over Current Release [A] ≥15 ≥10	Power supply requirements Rated Voltage [Vac] Max Apparent Resistance [Ω] Over Current Release [A]					CAUTION DO NOT MOVE ENTIRE X-RAY UNIT WITH ARM EXTENDED.
	CAUTION ! DO NOT RELEASE THIS BAND UNTIL X-RAY HEAD IS INSTALLED	CAUTION ! DO NOT RELEASE THIS BAND UNTIL X-RAY HEAD IS INSTALLED.			*1 : The color of black part is blue in the actual label.		

[2] MAJOR COMPONENTS

1. WALL MOUNT TYPE (WK)

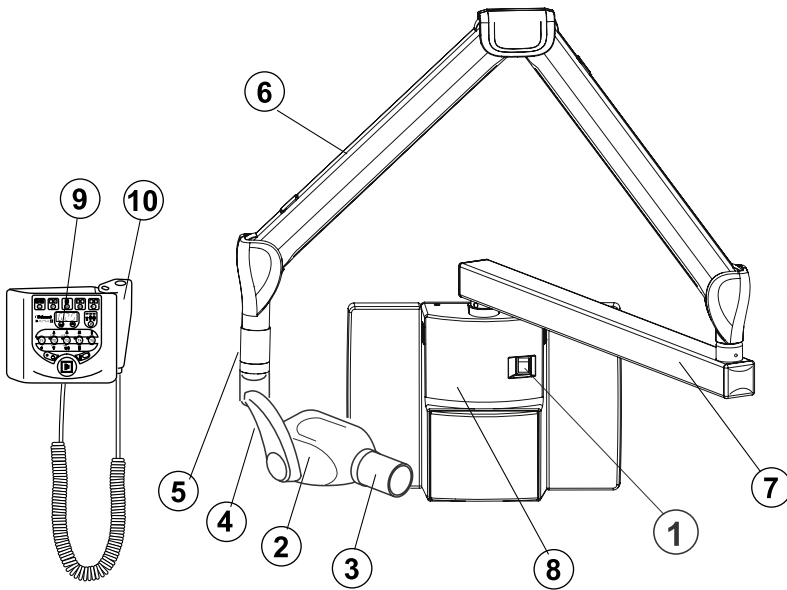

- ① Main Power Switch
- ② X-Ray Head
- ③ Cone
- ④ Yoke
- ⑤ Arm Collar
- ⑥ Balance Arm
- ⑦ Horizontal Arm
- ⑧ Main Controller
- ⑨ Sub Controller
- ⑩ Hand Exposure Switch (Option)

Fig.2-4 Major Components for WK

2. FOOR MOUNT TYPE (FK1/FK2)

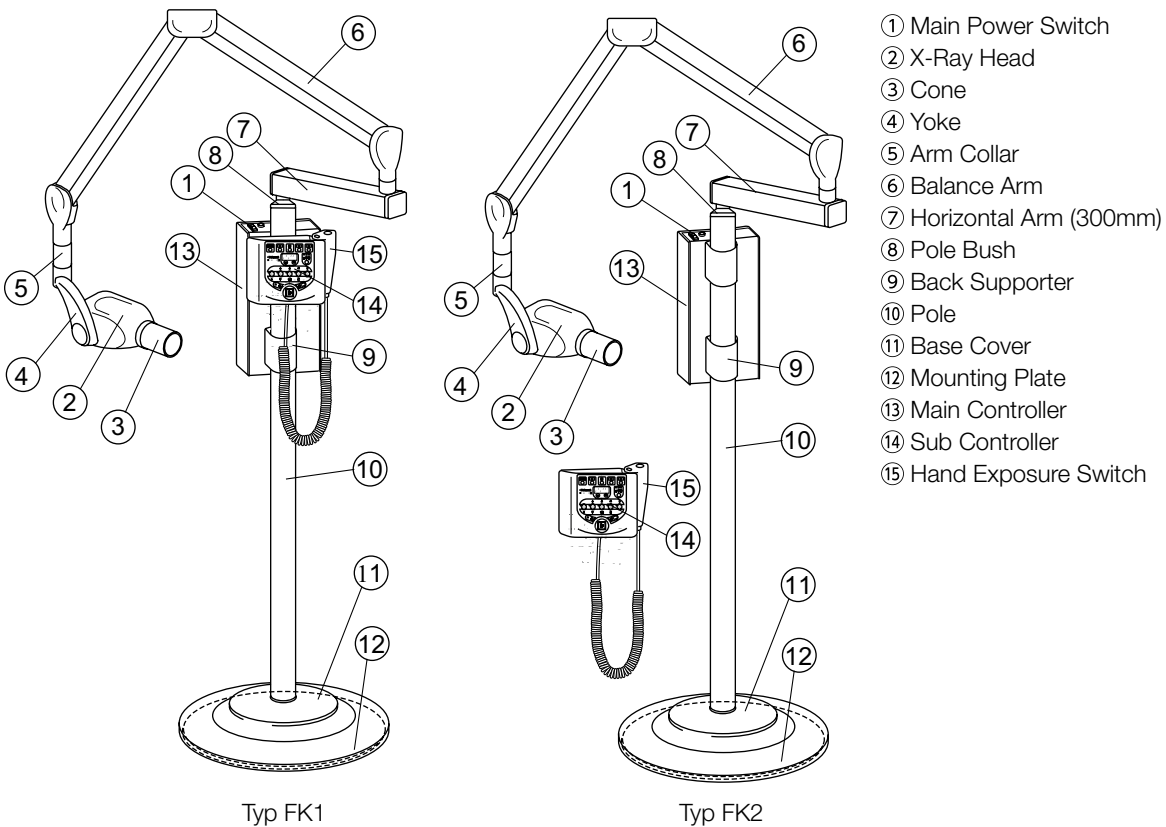

- ① Main Power Switch
- ② X-Ray Head
- ③ Cone
- ④ Yoke
- ⑤ Arm Collar
- ⑥ Balance Arm
- ⑦ Horizontal Arm (300mm)
- ⑧ Pole Bush
- ⑨ Back Supporter
- ⑩ Pole
- ⑪ Base Cover
- ⑫ Mounting Plate
- ⑬ Main Controller
- ⑭ Sub Controller
- ⑮ Hand Exposure Switch

Typ FK1

Typ FK2

Fig.2-1 Major Components for FK1/FK2

3. MOBILE TYPE (FM)

- ① Main Power Switch
- ② X-Ray Head
- ③ Cone
- ④ Yoke
- ⑤ Arm Collar
- ⑥ Balance Arm
- ⑦ Pole Bush
- ⑧ Pole
- ⑨ Pole Base
- ⑩ Leg Bar (long)
- ⑪ Leg Bar (Short)
- ⑫ Lock Caster
- ⑬ Standard Caster
- ⑭ Main Controller
- ⑮ Sub Controller
- ⑯ Hand Exposure Switch

⚠ WARNING

Keep casters in the lock position, unless moving the equipment. To avoid injury, do not push or lean on the equipment.

⚠ CAUTION

Do not move entire x-ray unit with arm extended.

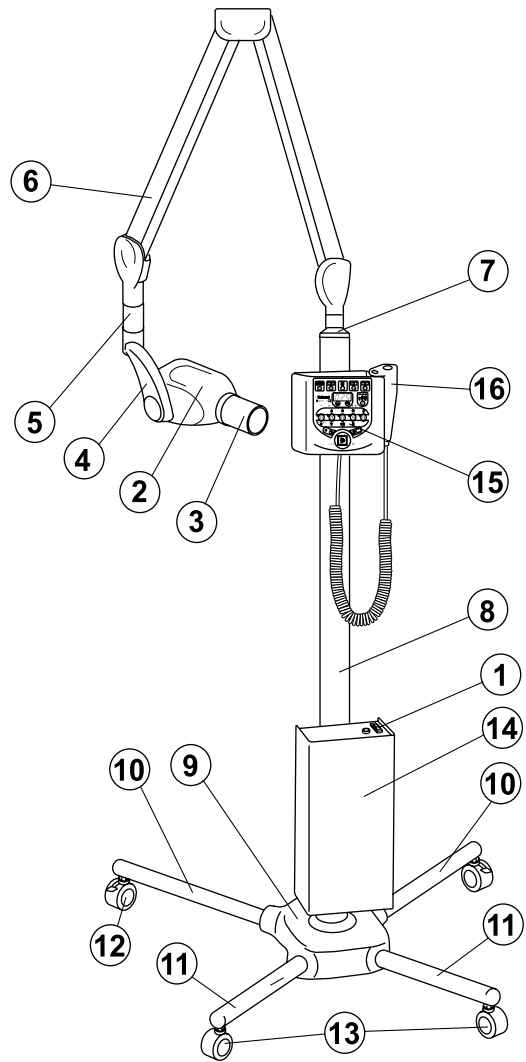

Fig.2-2 Major Components for FM

4. ROOM MOUNT TYPE (RK)

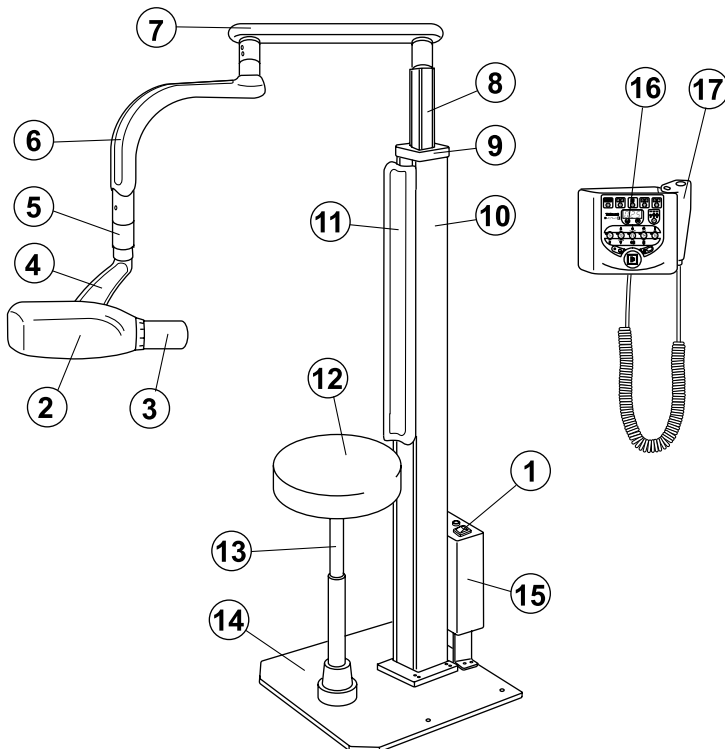

Fig.2-3 Major Components for RK

- ① Main Power Switch
- ② X-Ray Head
- ③ Cone
- ④ Yoke
- ⑤ Arm Collar
- ⑥ Swing Arm 1
- ⑦ Swing Arm 2
- ⑧ Sliding Post
- ⑨ Column Cover
- ⑩ Column
- ⑪ Backrest Cushion (applied part)
- ⑫ Seat (applied part)
- ⑬ Gas Cylinder
- ⑭ Base Plate
- ⑮ Main Controller
- ⑯ Sub Controller
- ⑰ Hand Exposure Switch(option)

5. CEILING MOUNT TYPE (CK)

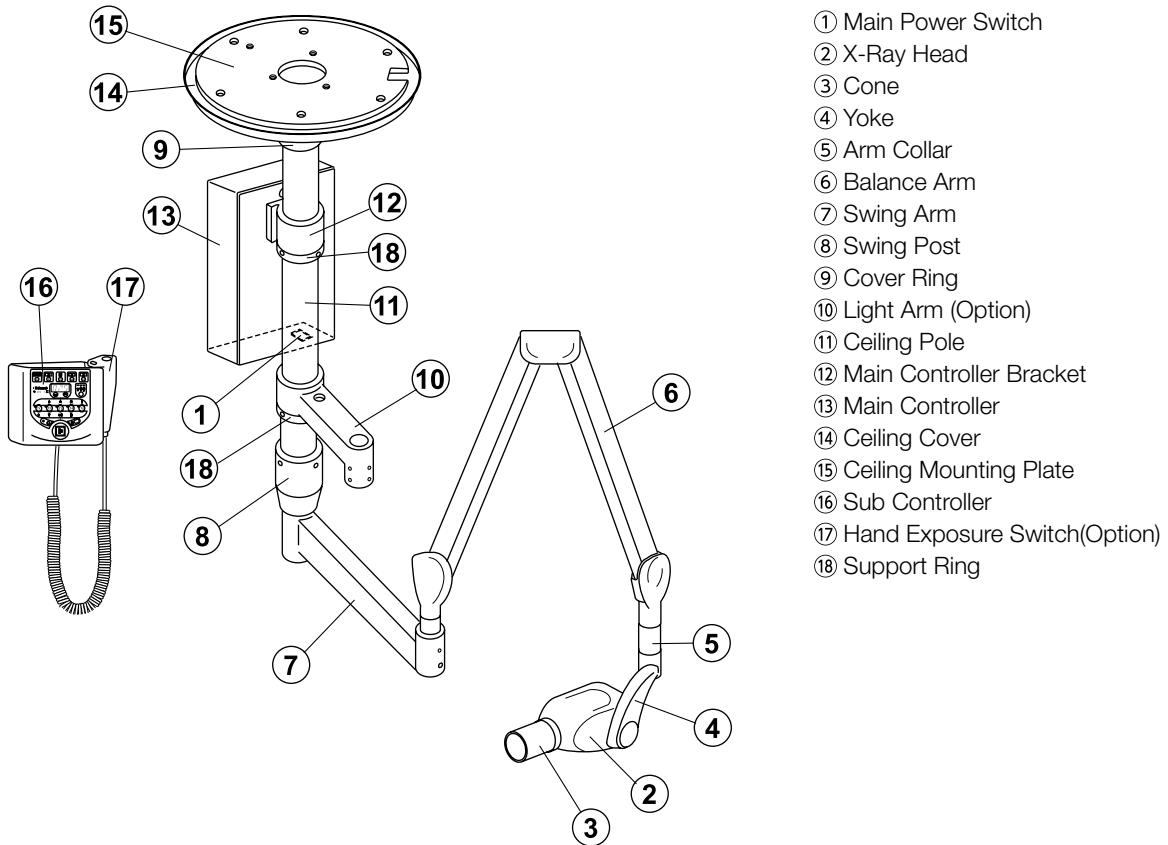

Fig.2-5 Major Components for CK

6. SUB CONTROLLER

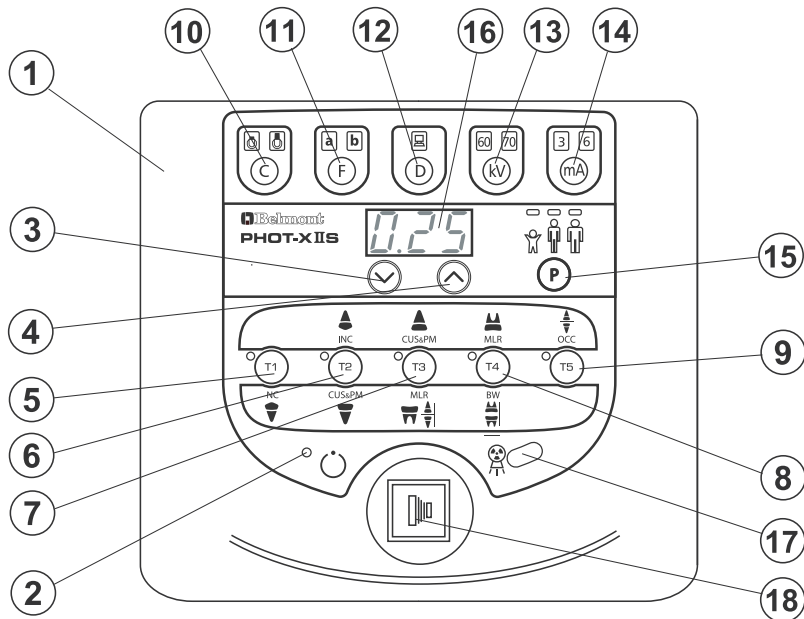

Fig.2-6 Sub C ontroller Switches

- | | |
|---|---------------------------------|
| ① Sub controller front panel | ⑩ Cone Type Selection Switch |
| ② Ready Light | ⑪ Film Speed Selection Switch |
| ③ Exposure Time Adjusting Switch (Down) | ⑫ Digital Imaging Switch |
| ④ Exposure Time Adjusting Switch (Up) | ⑬ kV Selection Switch |
| ⑤ Tooth Selection Switch (T1) | ⑭ mA Selection Switch |
| ⑥ Tooth Selection Switch (T2) | ⑮ Patient Size Selection Switch |
| ⑦ Tooth Selection Switch (T3) | ⑯ Exposure Time Display Window |
| ⑧ Tooth Selection Switch (T4) | ⑰ Exposure Warning Light |
| ⑨ Tooth Selection Switch (T5) | ⑱ Exposure Switch |

[3] FUNCTION OF CONTROLS

① Main Power Switch

Pushing the upper side of this switch to the ON position energizes the x-ray unit. (Ready light and pre-select lights for cone type, film or digital, kV, mA, and patient size illuminate.)



It is recommended to keep this switch OFF when the unit is not in use, in order to prevent an accidental exposure.

IMPORTANT: To prevent the risk of an accidental exposure, push the lower side of this switch to the OFF position, when the unit is not in use.

② Ready Light

This light illuminates when the line voltage is within operable range (207~253 Vac). When this light is not on, exposure can not be made.

③ ④ Exposure Time Adjusting Switches

By momentarily pushing the  (or ) switch, the exposure time displayed increases (or decreases) by one increment. By keeping the switch depressed more 2 sec., the exposure time displayed increases (or decreases) continuously until the switch is released.

Model 505 has the following 37 exposure time settings:

0.00, 0.01, 0.02, 0.03, 0.04, 0.05, 0.06, 0.07, 0.08, 0.09, 0.10, 0.11, 0.13, 0.14, 0.16, 0.18, 0.20, 0.22, 0.25, 0.28, 0.32, 0.36, 0.40, 0.45, 0.50, 0.56, 0.63, 0.71, 0.80, 0.90, 1.00, 1.12, 1.25, 1.40, 1.60, 1.80, 2.00 (sec.)

⑤ ~ ⑨ Tooth Selection Switches (T1-T5)

Pushing one of these switches sets the exposure time automatically for the following ⑩ ~ ⑮.

- ⑤ T1: Incisor of Mandible
- ⑥ T2: Incisor of Maxilla, Cuspid & Premolar of Mandible
- ⑦ T3: Cuspid & Premolar of Maxilla, Molars of Mandible, Bitewing
- ⑧ T4: Molar of Maxilla, Bitewing Molars
- ⑨ T5: Occlusal

If the T1 switch ⑤ is depressed more than 3 sec. unit goes into "Lock Mode". In lock mode, the only functional switch is the power switch. To exit from the lock mode, depress the T1 switch more than 3 sec. again.

⑩ Cone Type Selection Switch

By depressing this switch for less than 2 sec., selected cone type can be confirmed. If round cone is selected, "md" is displayed. If the cone with rectangular collimator is selected, "rEC" is displayed. Depressing this switch more than 2 sec. changes the cone type by the following order.

Short cone (Round) → Short cone with rectangular collimator → Long cone (Round) → Long cone with rectangular collimator → Short cone (Round) → continued

⑪ Film Speed Selection Switch



a. PHOT-X IIs has 16 film speed settings. (F.00-F.15)



Two speed settings are pre-set at the factory (a & b) and can be selected with switch ⑪

a = Film speed No. F.09 (equivalent to ISO speed group "D", or Kodak Ultra-Speed film)

b = Film speed No. F.05 (equivalent to ISO speed group "F/E", or Kodak InSight film)

Including these two speeds, PHOT-X IIs 505 x-ray can provide 16 different film speeds (F.00~F.15) and any two of them can be programmed for easy selection. If doctor uses a different film speed, or prefers darker (or lighter) radiographs, the new speed can be programmed as follows. Higher speed settings make films darker. If film speed is increased by 1, exposure time becomes 25 % longer.



1. Keep the kV selection switch and mA selection switch depressed simultaneously for more than 3 seconds. Release the switches if the ready light starts to flash.
2. Push F switch momentarily until the "a" light above the F switch illuminates. The exposure time display window shows the present film speed for "a" setting. (The factory default setting, F.09 should be displayed.) By depressing  or  switch, increase or decrease film speed number until desired number for "a" setting is displayed.

3. To change the “b” setting from the factory default, F.05, push F switch momentarily until the “b” light illuminates. By depressing  or  switch, increase or decrease film speed until the desired number for “b” setting is displayed.
 4. Press T1 switch to store these settings, then turn the main power switch off.
- b. Pushing **Film Speed Selection Switch** ⑪ momentarily displays the selected film speed setting in the **Exposure Time Display Window** ⑩
- Depressing this switch for more than 2 sec. changes the film type being selected.
- c. If the **Digital Imaging Switch** ⑫ is depressed, both of the film speed indicating lights (a & b) are turned off.

⑫ Digital Imaging Switch

If a digital imaging system is used, shorter exposure time is often required. PHOT-X IIs has 16 speeds for digital imaging (d.00~d.15). Pushing this switch momentarily displays the speed being selected in the **Exposure Time Display Window** ⑩. With the factory speed setting d.10, the exposure time becomes half of F.10 setting.

As the sensitivity is different according to each manufacturer of digital imaging sensors, this setting should be adjusted. To get a darker image, increase the speed setting and to get a lighter image, decrease the speed setting. If the speed setting is increased by 1, exposure time becomes 12 % longer.

1. Keep kV selection switch and mA selection switch depressed simultaneously for more than 3 seconds.
2. Push D switch momentarily until the light above the D switch illuminates and the exposure time display window shows the present speed setting. (The factory default setting d.10 should be displayed.)
3. By depressing  or  switch, increase or decrease speed until the desired number is displayed.
4. Press **T1 switch** to store these settings, then turn the main power switch off.

⑬ kV Selection Switch

Momentarily depressing this switch will change the tube potential to 60 or 70 kV. If either the Film Speed Switch ⑪ or Digital Imaging Switch ⑫ is depressed, 60kV is automatically selected.

⑭ mA Selection Switch

Momentarily depressing this switch will change the tube current setting (3 or 6 mA). If the Digital Imaging Switch ⑫ is depressed, 3 mA is automatically selected and if the Film Speed Switch ⑪ is depressed, 6 mA is automatically selected.

TABLE 1. Speed Setting and Exposure Time (Reguler Cone)

[unit : sec.]



Speed Setting	kV	mA	Child					Adult					Large Adult				
			T1	T2	T3	T4	T5	T1	T2	T3	T4	T5	T1	T2	T3	T4	T5
F.09	60	3	0.20	0.25	0.28	0.32	0.50	0.32	0.40	0.50	0.56	0.80	0.40	0.50	0.63	0.71	1.00
		6	0.10	0.11	0.14	0.16	0.25	0.16	0.20	0.25	0.28	0.40	0.20	0.25	0.28	0.36	0.50
	70	3	0.14	0.16	0.20	0.22	0.36	0.25	0.28	0.36	0.40	0.56	0.28	0.36	0.45	0.50	0.71
		6	0.07	0.08	0.10	0.11	0.18	0.11	0.14	0.18	0.20	0.28	0.14	0.18	0.22	0.25	0.36
F.05	60	3	0.08	0.10	0.11	0.14	0.20	0.14	0.16	0.20	0.22	0.32	0.18	0.20	0.25	0.28	0.40
		6	0.04	0.05	0.06	0.07	0.10	0.07	0.08	0.10	0.11	0.16	0.09	0.10	0.13	0.14	0.20
	70	3	0.06	0.07	0.08	0.10	0.14	0.10	0.11	0.14	0.16	0.25	0.13	0.14	0.18	0.20	0.28
		6	0.03	0.04	0.04	0.05	0.07	0.05	0.06	0.07	0.08	0.11	0.06	0.07	0.09	0.10	0.14
F.10	60	3	0.13	0.14	0.18	0.20	0.28	0.20	0.25	0.28	0.36	0.50	0.25	0.32	0.36	0.40	0.63
		6	0.06	0.07	0.09	0.10	0.14	0.10	0.13	0.14	0.16	0.25	0.13	0.16	0.18	0.22	0.32
	70	3	0.09	0.11	0.13	0.14	0.22	0.14	0.18	0.22	0.25	0.36	0.18	0.22	0.25	0.32	0.45
		6	0.04	0.05	0.06	0.07	0.11	0.07	0.09	0.11	0.13	0.18	0.09	0.11	0.13	0.16	0.22

TABLE 2. Speed Setting and Exposure Time (Long Cone)

[unit : sec.]

Speed Setting	kV	mA	Child					Adult					Large Adult				
			T1	T2	T3	T4	T5	T1	T2	T3	T4	T5	T1	T2	T3	T4	T5
F.09	60	3	0.40	0.50	0.63	0.71	1.00	0.71	0.80	1.00	1.12	1.60	0.90	1.00	1.25	1.40	2.00
		6	0.20	0.25	0.28	0.36	0.50	0.36	0.40	0.50	0.56	0.80	0.45	0.50	0.63	0.71	1.00
	70	3	0.28	0.36	0.45	0.50	0.71	0.50	0.56	0.71	0.80	1.25	0.63	0.71	0.90	1.00	1.40
		6	0.14	0.18	0.22	0.25	0.36	0.25	0.28	0.36	0.40	0.56	0.32	0.36	0.45	0.50	0.71
F.05	60	3	0.18	0.20	0.25	0.28	0.40	0.28	0.36	0.40	0.45	0.71	0.36	0.45	0.50	0.56	0.90
		6	0.09	0.10	0.13	0.14	0.20	0.14	0.18	0.20	0.25	0.36	0.18	0.22	0.25	0.28	0.45
	70	3	0.13	0.14	0.18	0.20	0.28	0.20	0.25	0.28	0.32	0.50	0.25	0.32	0.36	0.40	0.63
		6	0.06	0.07	0.09	0.10	0.14	0.10	0.13	0.14	0.16	0.25	0.13	0.16	0.18	0.22	0.32
F.10	60	3	0.25	0.32	0.36	0.45	0.63	0.45	0.50	0.63	0.71	1.00	0.56	0.63	0.80	0.90	1.25
		6	0.13	0.16	0.18	0.22	0.32	0.22	0.25	0.32	0.36	0.50	0.28	0.32	0.40	0.45	0.63
	70	3	0.18	0.22	0.28	0.32	0.45	0.32	0.36	0.45	0.50	0.71	0.40	0.45	0.56	0.63	0.90
		6	0.09	0.11	0.13	0.16	0.22	0.16	0.18	0.22	0.25	0.36	0.20	0.22	0.28	0.32	0.45

⑮ Patient Size Selection Switch

This switch alters the selection of patient type/size to be radiographed (child → adult → large adult → child) and sets the exposure time automatically. If the weight of child is less than 20kg, press  switch once after setting to child. If the weight of child is over 30kg and less than 50kg, press  switch once after setting to child. If the weight of child is over 50kg and less than 70kg, press  switch twice after setting to child. If the weight of child is over 70kg, set to adult.

NOTE: Setting or adjusting the exposure time manually (with  or  switch) supersedes ⑤ ~ ⑮ functions.

⑯ Exposure Time Display Window

This window displays the selected exposure time. Estimated air kerma (radiation output) at distal end of cone can be displayed in this window by manual operation or automatically after the exposure. If an abnormal condition exists or a malfunction occurs, an Error Code is also displayed in this window. (See Section: [9] ERROR CODES)

⑰ Exposure Warning Light

Illumination of this light indicates the unit is producing x-radiation.

⑱ Exposure Switch

This switch initiates radiographic exposure. When making an exposure, depress and hold this switch until the **Exposure Warning Light** ⑰ and the audible warning shut off. Failure to keep this switch depressed will result in the premature termination of the exposure and an error code E.00 will be displayed in **Exposure Time Display Window** ⑯.

[4] OPERATING PROCEDURES

1. Turn ON the Main Power Switch ①.
2. Confirm that Ready Light ② is illuminated.

NOTE: The ready light will not illuminate unless the incoming line voltage is correct and within the x-ray's operable range (207 ~ 253 Vac).

3. Select the appropriate tooth type (⑤ ~ ⑨), and confirm the pre-selected conditions (cone type, film or digital, kV, mA and patient size) are suitable for exposure.

NOTE: To manually set the exposure time, depress either of the Manual Exposure Time Adjusting Switches (⤴ or ⤵) until the desired exposure time appears in the Exposure Time Display Window ⑬. While the unit is in manual mode, other selection switches (⑤ ~ ⑩) do not affect exposure time. (All of the tooth selection lights are off.)

To return to the automatic exposure time selection mode, depress any one of Tooth Selection Switches (⑤ ~ ⑨).

4. Depress the Exposure Switch ⑭. When the Exposure Switch is depressed, the Exp. Warning Light ⑰ illuminates and the audible warning sounds. Do not release the Exposure Switch until the Exposure Warning Light and audible warning automatically shut off. Failure to keep the switch depressed will result in exposure being terminated prematurely.
5. To continue to radiograph other teeth, just select appropriate Tooth Selection Switches (⑤ ~ ⑨).

IMPORTANT: To protect x-ray tubehead from heat accumulation, wait for a time interval that is equal to 30 times the selected exposure time before making additional exposures. (Example : a 15 sec. wait is necessary between exposures that are 0.5 sec. in duration.)

6. Turn OFF the Main Power Switch ① in order to prevent accidental exposures when the unit is not in use.

NOTE: If the unit left over 8 min. without being operated and the Main Power Switch ① is kept on, figure "1" runs through the Exposure Time Display Window ⑬. This does not mean that malfunction of the unit has occurred ; this is an energy saving feature. The unit returns to ready condition by pressing any one of the switches, except the Exposure Switch ⑭.

[5] ESTIMATED AIR KERMA

Estimated air kerma (radiation output) at distal of cone can be displayed in the exposure time window by depressing the patient switch for more than 1 second. Unit for this value is mGy and this value is calculated by kV, mA, Exposure time and cone type selected at that time.

Patient type display lamps and displayed value in the window are flashing in this mode and if either of the manual exposure time adjusting switch is depressed during this mode, accumulated air kerma will be displayed. Accumulated value will be reset when the power switch is turned off or leave the x-ray unit more than 8 minutes without depressing any switch. To return to normal mode, press the patient switch for more than 1 second again or leave the controller untouched for more than 10 seconds.

[6] OPTIONAL HAND EXPOSURE SWITCH

An optional hand exposure switch can be connected to the sub controller. Since this exposure switch has a coiled cord, operators can stand in the most suitable position for operation. As controller has separate connector for this exposure switch, both exposure switch ⑱ on the front panel of sub controller and this hand exposure switch can be used.

If local code prohibits use of both, asks installer to disconnect the connector of either switch.

NOTE : This hand exposure switch is included with FM and FK1/FK2 type x-ray unit.

[7] DIGITAL IMAGING SYSTEM

No x-ray image receptor is integrated into the PHOT-X IIs 505 x-ray system. If a receptor for digital imaging is used with PHOT-X IIs 505, the type and performance of the image receptor should be as follows.

1. Type of receptor : CCD (charge-coupled device), CMOS (complementary metal oxide semiconductor) or PSP (photostimulable phosphor plate) receptor for dental intraoral use.
2. Adequate dose of x-radiation for the receptor should be between 0.02mGy and 23.6mGy.
3. Use the receptor holder and receptor cover recommended by the manufacturer of image receptor.
4. Receptor holder should hold the image receptor firmly in position and work as the x-ray beam alignment device.

WARNING

The use of ACCESSORY equipment not complying with the equivalent safety requirements of the PHOT-X IIs 505 may lead to a reduced level of safety of the resulting system.

Consideration relating to the choice shall include :

- accessory should be CE marked
- evidence that the safety certification of the ACCESSORY has been performed in accordance to the appropriate IEC60601-1 and IEC60601-1 harmonized national standard.

[8] INFECTION CONTROL AND CLEANING

1. INFECTION PREVENTION

X-ray operators are required to wear disposable gloves when taking radiographs and handling contaminated film packets or digital detector cover. Gloves should be changed for each patient to avoid cross contamination. X-ray head, main controller and sub controller should be covered by single use barriers.

CAUTION

If holders for film or digital detector are used, properly sterilize them according to the procedures indicated by each manufacturer of holders.

2. CLEANING

In order to ensure proper hygiene and cleaning of the equipment, the following procedures must be followed.

CAUTION

Before cleaning the unit, turn off the main power switch and breaker on the branch line. This is required because some internal parts remain connected to main voltage even when the main power switch has been turned off.

Never use the corrosive disinfectants, such as povidone iodine or sodium hypochlorite. Do not pour or spray solvent or liquid directly on the x-ray unit.

Be careful not to allow solvents to run or drip into the x-ray unit.

- a. Turn off the main power switch and breaker on the branch line.
- b. Wipe the outside surface with a paper towel dampened with a disinfectant solution or household, non-abrasive cleaner.
Recommended disinfectant : FD333 (Durr Dental GmbH)
- c. Allow surface to air dry before turning breaker and main switch back on.

[9] ERROR CODES

If an abnormal condition exists in the unit, or a malfunction occurs, an error code is displayed in the Exposure Time Display Window. Please refer to the Table below.

Error Code	Condition	Step to be Taken	Possible Solution
E.00	Exposure switch was released before exposure termination.	1 the tooth selection lights blink. Depress one of the tooth switches.	Release the exposure switch after the exposure lamp turns off.
E.01	Exposure switch was depressed within 10 sec. of previous exposure.	A 10 sec. delay is built in between each exposure. Release the exposure switch.	There should be a "wait" interval of 30 times the exposure time between successive exposure.
	Exposure time was set and exposure switch was depressed within 3 sec. of the power switch being turned on.		Wait a minimum 3 sec. after the main power switch is turned on before pressing the exposure switch.
E.02	Line voltage was less than 90 of rated voltage.		Confirm that ready lamp is on before exposure.
E.03	Line voltage was more than 110 of rated voltage.		Ask service personnel to check the line voltage.
E.05	Tube current at last portion of exposure was less than 2 mA at 3 mA setting or less than 4.5 mA at 6 mA setting	Turn off the main power switch and wait for approximately 2 min. Turn on the main power switch again.	If same error code is displayed, call service personnel.
E.06	Tube current at last portion of exposure was more than 4 mA at 3 mA setting or more than 7.5 mA at 6 mA setting		
E.07	During the exposure, tube current becomes less than 1.5 mA at 3mA setting or less than 3 mA at 6 mA setting.		
E.08	During the exposure, tube current becomes more than 4.5 mA at 3mA setting or more than 9 mA at 6 mA setting.		
E.09	Setting for pre-heating time is out of range.		
E.10	Exposure switch or exposure circuit had been ON, when main power switch is turned on.		
E.11	Tube current is detected during pre-heating period.		
E.12	Tube current is detected when main power switch is turned on.		
E.14	Tube potential at last portion of exposure was less than 50 kV at 60 kV setting or less than 60 kV at 70 kV setting.		
E.15	Tube Potential at last portion of exposure was more than 70 kV at 60 kV setting.		
E.16	During the exposure, tube potential becomes less than 0 kV at 60 kV setting or less than 50 kV at 70 kV setting.		
E.17	During the exposure, tube potential becomes more than 80 kV.		
E.18	Excess current was detected in primary circuit of filament transformer.		
E.19	Excess current was detected in primary circuit of high voltage transformer.		

Error Code	Condition	Step to be Taken	Possible Solution
E.20	Exposure switch was depressed when tube head temperature was over 60°C.	Release the exposure switch,	If same error code is displayed, call service personnel.
E.22	Failure of electrical communication between the power PCB and timer PCB.	Turn off the main power witch and turn on again	
E.23	Some switch had been on, when the main power switch is turned on. (Except the exposure switch.)		

[10] MAINTENANCE

PHOT-X IIs 505 x-ray unit requires post installation confirmation and periodic maintenance checks to be performed by dealer service personnel. These procedures ensure that the x-ray unit is functioning within the manufacture's specifications and remains in compliance with the Standard.

It is responsibility of the owner of the unit to see that these maintenance checks are correctly performed. The specific instructions to perform these checks are located within the PHOT-X IIs 505 Installation instructions.

- a. Maintenance personnel : Qualified dealer service personnel who has the experience with Belmont's x-ray or has been trained by Belmont. But item 7 - 14 of the maintenace check list on page 13 should be verified routinely by treatment room personnel.
- b. Specification of the parameters to be monitored and monitoring frequency: Refer to the maintenance check list on page 13.
- c. Acceptance limit : Refer to the Maintenance check list on page 13.
- d. Required action when failed : Refer to the Maintenance check list on page 13.
- e. Tools to maintain quality control logs : Use the check list on page 13.
- f. Training material : Operator's instructions, Installation instructions and Service manual.

MAINTENANCE CHECK LIST

Parameter	Acceptance limit	Frequency	Procedures when failed	OK/NG
1. Line voltage	Confirm the line voltage is within 230V±10%. Also confirm the voltage drop during exposure is within 3%.	Yearly	Connect to the power supply within 230V±10%. Check disconnection of wire or connection failure. Repair cable connection as needed.	
2. Tube current	Confirm the measured mA value indicated on the LED window is within the rated value ± 1 mA.	Yearly	Perform MA adjustment. (Refer to installation instructions.)	
3. Tube potential	Confirm the measured kV value indicated on the LED window is within the rated value ±10%.	Yearly	Check the tube potential compensation (CP) values are same as the values on the label in the head yoke.	
4. Mounting plate for wall (WK), ceiling (CK) or floor (FK1/FK2)	Confirm the plate is firmly fixed to the wall (WK), ceiling (CK) or floor (FK1/FK2).	Yearly	If bolts are loose, find the reason why bolts became loose and take counter measure that prevents bolts become loose.	
5. Arm mounting bracket (WK)	Make sure that the arm bracket is firmly attached to the wall or wall plate.	Yearly		
6. Pole (FK1/FK2, CK)	Make sure the pole is securely attached to the mounting plate.	Yearly		

Parameter	Acceptance limit	Frequency	Procedures when failed	OK/NG
7. Dosimetry	Save the image that was taken under appropriate conditions as a reference image. Compare a newly taken image with a reference image to assure the image quality.	Weekly	If the image quality is found poor comparing to a reference image, check the condition of image receptor (film, sensor or imaging plate), image developer (developing fluid, dental film developer, PC or scanner).	
8. Horizontal arm (WK, FK1/ FK2)	Confirm that horizontal arm is firmly inserted to the arm bracket. Make sure the retaining bolt is firmly inserted to the arm bracket.	Daily (before use)	If the retaining bolt is loose, find the reason why bolt became loose, take counter measure that prevent the retaining bolt become loose.	
9. Head	Confirm the head can be smoothly positioned.	Daily (before use)	Adjust the brake screws by referring to installation instructions.	
10. Vertical movement of balance arm	Confirm the balance arm moves smoothly without making noise.	Daily (before use)	Adjust the tension of the balance arm by referring to installation instructions. If the balance arm makes noise, apply grease.	
11. Swing angle of balance arm (FM)	Confirm the balance arm swings between two long legs.	Daily (before use)	Check the stopper screws and mounting screws of pole bushing.	
12. Caster (FM)	Confirm all casters move smoothly and lock function works fine by two lock casters.	Daily (before use)	Clean up the casters or replace them.	
13. Sliding post (RK)	Confirm the post slides smoothly.	Daily (before use)	Check the rollers of sliding post.	
14. Swing arm (CK, RK)	Confirm the joints of the swing arms are connected firmly and stopper and friction are adequate.	Daily (before use)	Check the keys, stopper ring, stopper screws and brake screw of swing arm, and change them as necessary.	

[11] TECHNICAL DATA

1. X-ray tube-----D-046 (Stationary Anode)
 - a. Nominal focal spot value-----0.4
 - b. Target Material-----Tungsten
 - c. Target angle-----12.5 deg
 - d. Maximum anode heat content -----4.3 kJ (6.1 kHU)
2. Maximum x-ray tube assembly heat content -----293 kJ (413 kHU)
3. Rated peak tube potential-----60 kV / 70 kV selectable
4. Rated tube current -----3 mA / 6 mA selectable
5. Maximum rated peak tube potential-----70 kV
6. Rated line voltage -----230 VAC, 50/60 Hz, Single phase, 1.4 kVA
7. Line voltage range-----207 VAC - 253 VAC
8. Range of line voltage regulation-----0 - 3 % (Apparent resistance 1.02 ohm)
9. Rated line current -----6 A at 70 kV, 6 mA
10. Maximum line current -----7 A at 70 kV, 6 mA
11. Exposure time -----0.01 - 2.0 sec.
12. Inherent filtration-----1.7 mm Al Equivalent
13. Added filtration -----0.3 mm Al
14. Minimum filtration permanently in useful beam-----2.0 mm Al Equivalent at 70 kV
15. Nominal radiation output -----Refer to Nominal Radiation Output Table on the next page.
16. Nominal electrical output of H.V. generator -----0.42 kW at 70 kV, 6 mA
17. Cone-----Source to skin distance Field size
 - a. Regular cone -----203 mm 58 mm dia., circular
 - b. Long cone (option) -----305 mm 58 mm dia., circular
 - c. Rectangular collimator (option)-----SSD of cone + 40mm 32 x 40 mm, rectangular
18. Maximum symmetrical radiation field-----60 mm dia. at distal end of cone
19. Leaking technique factor -----70 kV / 0.19 mA (697mAs at 1 hour)
(0.19 mA is maximum rated continuous current for 6mA with a duty cycle 1:30)
20. Duty cycle-----1 : 30 (0.5 sec. exposure with 15 sec. interval)
21. Maximum deviation of tube potential, tube current and exposure time
 - a. Below 0.1 sec. setting -----±10 kV, ±2 mA, ±5 msec.
 - b. 0.1 sec. setting & up-----±5 kV, ±1 mA, ±10 msec.
22. Measurement base of technique factors
 - a. peak tube potential-----Average of peak tube potentials during one exposure
 - b. tube current-----Average of tube current during one exposure
 - c. exposure time-----Time period during x-ray is emitted
23. Half value layer -----1.5 mm Al over
24. Source to the base of cone distance-----94 mm
25. Environmental condition for storage-----20 - 70 °C, 10 - 100 %, 500 - 1060 hPa
26. Environmental condition for operation-----10 - 40 °C, 30 - 70 %, 700 - 1060 hPa
27. Dose area product -----Estimated air kerma displayed [mGy]
x 26.4 [cm²] (for regular and long cone) Estimated air
kerma displayed [mGy]
x 12.8 [cm²] (for rectangular collimator)
28. Service life-----10 years

Nominal Radiation Output Table

Exp. Time [sec.]	Nominal Radiation Output															
	without Rectangular Collimator								with Rectangular Collimator							
	60 kV				70 kV				60 kV				70 kV			
	Regular Cone		Long Cone		Regular Cone		Long Cone		Regular Cone		Long Cone		Regular Cone		Long Cone	
	3mA	6mA	3mA	6mA	3mA	6mA	3mA	6mA	3mA	6mA	3mA	6mA	3mA	6mA	3mA	6mA
0.00	0.00	0.00	0.00	0.00	0.00	0.00	0.00	0.00	0.00	0.00	0.00	0.00	0.00	0.00	0.00	0.00
0.01	0.05	0.09	0.02	0.04	0.06	0.12	0.03	0.05	0.03	0.06	0.02	0.03	0.04	0.08	0.02	0.04
0.02	0.09	0.18	0.04	0.08	0.12	0.24	0.05	0.10	0.06	0.13	0.03	0.06	0.08	0.16	0.04	0.08
0.03	0.14	0.27	0.06	0.12	0.18	0.35	0.08	0.16	0.10	0.19	0.05	0.09	0.12	0.25	0.06	0.12
0.04	0.18	0.37	0.08	0.16	0.24	0.47	0.10	0.21	0.13	0.26	0.06	0.13	0.16	0.33	0.08	0.16
0.05	0.23	0.46	0.10	0.20	0.30	0.59	0.13	0.26	0.16	0.32	0.08	0.16	0.21	0.41	0.10	0.20
0.06	0.27	0.55	0.12	0.24	0.35	0.71	0.16	0.31	0.19	0.38	0.09	0.19	0.25	0.49	0.12	0.24
0.07	0.32	0.64	0.14	0.28	0.41	0.83	0.18	0.37	0.22	0.45	0.11	0.22	0.29	0.58	0.14	0.29
0.08	0.37	0.73	0.16	0.32	0.47	0.94	0.21	0.42	0.26	0.51	0.13	0.25	0.33	0.66	0.16	0.33
0.09	0.41	0.82	0.18	0.36	0.53	1.06	0.24	0.47	0.29	0.57	0.14	0.28	0.37	0.74	0.18	0.37
0.10	0.46	0.91	0.20	0.41	0.59	1.18	0.26	0.52	0.32	0.64	0.16	0.32	0.41	0.82	0.20	0.41
0.11	0.50	1.01	0.22	0.45	0.65	1.30	0.29	0.58	0.35	0.70	0.17	0.35	0.45	0.91	0.22	0.45
0.13	0.59	1.19	0.26	0.53	0.77	1.53	0.34	0.68	0.41	0.83	0.21	0.41	0.54	1.07	0.27	0.53
0.14	0.64	1.28	0.28	0.57	0.83	1.65	0.37	0.73	0.45	0.89	0.22	0.44	0.58	1.15	0.29	0.57
0.16	0.73	1.46	0.32	0.65	0.94	1.89	0.42	0.84	0.51	1.02	0.25	0.51	0.66	1.32	0.33	0.65
0.18	0.82	1.65	0.36	0.73	1.06	2.12	0.47	0.94	0.57	1.15	0.28	0.57	0.74	1.48	0.37	0.73
0.20	0.91	1.83	0.41	0.81	1.18	2.36	0.52	1.05	0.64	1.28	0.32	0.63	0.82	1.65	0.41	0.82
0.22	1.01	2.01	0.45	0.89	1.30	2.60	0.58	1.15	0.70	1.40	0.35	0.70	0.91	1.81	0.45	0.90
0.25	1.14	2.29	0.51	1.01	1.48	2.95	0.65	1.31	0.80	1.60	0.40	0.79	1.03	2.06	0.51	1.02
0.28	1.28	2.56	0.57	1.13	1.65	3.30	0.73	1.46	0.89	1.79	0.44	0.89	1.15	2.31	0.57	1.14
0.32	1.46	2.93	0.65	1.30	1.89	3.78	0.84	1.67	1.02	2.04	0.51	1.01	1.32	2.64	0.65	1.31
0.36	1.65	3.29	0.73	1.46	2.12	4.25	0.94	1.88	1.15	2.30	0.57	1.14	1.48	2.97	0.73	1.47
0.40	1.83	3.66	0.81	1.62	2.36	4.72	1.05	2.09	1.28	2.55	0.63	1.27	1.65	3.29	0.82	1.63
0.45	2.06	4.12	0.91	1.82	2.66	5.31	1.18	2.35	1.44	2.87	0.71	1.42	1.85	3.71	0.92	1.84
0.50	2.29	4.57	1.01	2.03	2.95	5.90	1.31	2.61	1.60	3.19	0.79	1.58	2.06	4.12	1.02	2.04
0.56	2.56	5.12	1.13	2.27	3.30	6.61	1.46	2.93	1.79	3.57	0.89	1.77	2.31	4.61	1.14	2.29
0.63	2.88	5.76	1.28	2.55	3.72	7.43	1.65	3.29	2.01	4.02	1.00	1.99	2.59	5.19	1.29	2.57
0.71	3.25	6.49	1.44	2.88	4.19	8.38	1.86	3.71	2.27	4.53	1.12	2.25	2.92	5.85	1.45	2.90
0.80	3.66	7.32	1.62	3.24	4.72	9.44	2.09	4.18	2.55	5.11	1.27	2.53	3.29	6.59	1.63	3.27
0.90	4.12	8.23	1.82	3.65	5.31	10.6	2.35	4.70	2.87	5.74	1.42	2.85	3.71	7.4	1.84	3.67
1.00	4.57	9.15	2.03	4.05	5.90	11.8	2.61	5.23	3.19	6.38	1.58	3.16	4.12	8.2	2.04	4.08
1.12	5.12	10.2	2.27	4.54	6.61	13.2	2.93	5.85	3.57	7.1	1.77	3.54	4.61	9.2	2.29	4.57
1.25	5.72	11.4	2.53	5.06	7.38	14.8	3.27	6.53	3.99	8.0	1.98	3.96	5.15	10.3	2.55	5.10
1.40	6.40	12.8	2.84	5.67	8.26	16.5	3.66	7.32	4.47	8.9	2.21	4.43	5.77	11.5	2.86	5.72
1.60	7.32	14.6	3.24	6.48	9.44	18.9	4.18	8.36	5.11	10.2	2.53	5.06	6.59	13.2	3.27	6.53
1.80	8.23	16.5	3.65	7.29	10.6	21.2	4.70	9.41	5.74	11.5	2.85	5.70	7.41	14.8	3.67	7.35
2.00	9.15	18.3	4.05	8.10	11.8	23.6	5.23	10.5	6.38	12.8	3.16	6.33	8.24	16.5	4.08	8.17

unit: [mGy] $\pm 50\%$

[12] ELECTROMAGNETIC COMPATIBILITY (EMC)

This product conforms to EMC standard EN60601-1-2:2015.

1. Caution to EMC and Compliance with information in attached document

Medical electrical equipment requires special attention to EMC and it must be installed and used according to the EMC information provided in this instruction manual. Do not install in the vicinity of the electrosurgical device being output or electromagnetically shielded room of ME system for MRI diagnostic imaging because the electromagnetic interference intensity is high.

WARNING

- a. Use of this equipment adjacent to or stocked with other equipment should be avoided because it could result in improper operation. If such use is necessary, this equipment and the other equipment should be observed to verify that they are operating normally.**
- b. Use of accessories, transducers and cables other than those specified or provided by the manufacturer of this equipment could result in increased electromagnetic emissions or decreased electromagnetic immunity of this equipment and result in improper operation.**
- c. Portable RF communications equipment (including peripherals such as antenna cables and external antennas) should be used no closer than 30cm (12 inches) to any part of the PHOT-X IIs 505, including cables specified by the manufacturer. Otherwise, degradation of the performance of this equipment could result.**

2. Electromagnetic emissions

Emissions test	Test procedure	Compliance	Note : The emissions characteristics of this equipment make it suitable for use in industrial areas and hospitals (CISPR 11 class A). If it is used in a residential environment (for which CISPR 11 class B is normally required) this equipment might not offer adequate protection to radio-frequency communication services. The user might need to take mitigation measures, such as relocating or re-orienting the equipment.
Conducted and radiated RF emissions	CISPR11	Group 1 Class A	
Harmonic distortion	EN61000-3-2	N/A ^(*1)	
Voltage fluctuations and flicker	EN61000-3-3	Clause 5	

(*1) : The test is not applicable since professional equipment is rated power 1kW or more.

3. Electromagnetic immunity

Immunity test	EN 60601 test level	Compliance level	Electromagnetic environment - guidance
Electrostatic discharge (ESD) EN61000-4-2	±8 kV contact ±15 kV air	±8 kV contact ±15 kV air	Floors should be wood, concrete or ceramic tile. If floors are covered with synthetic material, the relative humidity should be at least 30%.
Electrical fast transient/burst EN61000-4-4	±2 kV for power supply lines ±1 kV for input/output lines	±2 kV for power supply lines ±1 kV for input/output lines	Mains power quality should be that of a typical commercial or hospital environment.
Surge EN61000-4-5	±1 kV differential mode ±2 kV common mode	±1 kV differential mode ±2 kV common mode	Mains power quality should be that of a typical commercial or hospital

Immunity test	EN 60601 test level	Compliance level	Electromagnetic environment - guidance
Voltage dips, short interruptions and voltage variations on power supply input lines EN61000-4-11	<u>dips</u> 0 %Ut: 0.5 cycle (0, 45, 90, 135, 180, 225, 270 and 315 degree) 0 %Ut: 1 cycle (0 degree) 70 %Ut: 25/30 cycles (0 degree) <u>short interruptions</u> 0 %Ut: 250/300 cycles Ut: Rated voltage of EUT	<u>dips</u> 0 %Ut: 0.5 cycle (0, 45, 90, 135, 180, 225, 270 and 315 degree) 0 %Ut: 1 cycle (0 degree) 70 %Ut: 25/30 cycles (0 degree) <u>short interruptions</u> 0 %Ut: 250/300 cycles Ut: Rated voltage of EUT	Mains power quality should be that of a typical commercial or hospital environment. If the user of the PHOT-X IIs 505 x-ray requires continued operation during power mains interruptions, it is recommended that the PHOT-X IIs 505 x-ray be powered from an uninterruptible power supply or a battery.
Power frequency (50/60Hz) magnetic field EN61000-4-8	30 A/m	30 A/m	Power frequency magnetic fields should be at levels characteristic of a typical location in a typical commercial or hospital environment.
Conducted RF EN61000-4-6	AC/DC power and Signal input/output 0.15 MHz - 80 MHz: 3V 6 V in ISM bands between 0.15 MHz - 80MHz (unmodulated, r.m.s.) 80 % AM (1 kHz)	AC/DC power and Signal input/output 0.15 MHz - 80 MHz: 3V 6 V in ISM bands between 0.15 MHz - 80MHz (unmodulated, r.m.s.) 80 % AM (1 kHz)	Portable RF communications equipment (including peripherals such as antenna cables and external antennas) should be used no closer than 30cm (12 inches) to any part of the PHOT-X IIs 505, including cables specified by the manufacturer. Otherwise, degradation of the performance of this equipment could result.
Radiated RF EN61000-4-3	80 MHz - 2700 MHz: 3V/m (unmodulated, r.m.s.) 80 % AM (1kHz)	80 MHz - 2700 MHz: 3V/m (unmodulated, r.m.s.) 80 % AM (1kHz)	
Proximity fields from RF wireless communication equipment EN61000-4-3	385 MHz 27 V/m (unmodulated, r.m.s.) Pulse modulation 18 Hz	385 MHz 27 V/m (unmodulated, r.m.s.) Pulse modulation 18 Hz	
	450 MHz 28 V/m (unmodulated, r.m.s.) FM ± 5 kHz deviation 1 kHz sine or Pulse modulation 18 Hz	450 MHz 28 V/m (unmodulated, r.m.s.) FM ± 5 kHz deviation 1 kHz sine or Pulse modulation 18 Hz	
	710 MHz, 745 MHz, 780 MHz 9 V/m (unmodulated, r.m.s.) Pulse modulation 217 Hz	710 MHz, 745 MHz, 780 MHz 9 V/m (unmodulated, r.m.s.) Pulse modulation 217 Hz	
	810 MHz, 870 MHz, 930 MHz 28 V/m (unmodulated, r.m.s.) Pulse modulation 18 Hz	810 MHz, 870 MHz, 930 MHz 28 V/m (unmodulated, r.m.s.) Pulse modulation 18 Hz	
	1720 MHz, 1845 MHz, 1970 MHz 28 V/m (unmodulated, r.m.s.) Pulse modulation 217 Hz	1720 MHz, 1845 MHz, 1970 MHz 28 V/m (unmodulated, r.m.s.) Pulse modulation 217 Hz	
	2450 MHz 28 V/m (unmodulated, r.m.s.) Pulse modulation 217 Hz	2450 MHz 28 V/m (unmodulated, r.m.s.) Pulse modulation 217 Hz	
5240 MHz, 5500 MHz, 5785 MHz 9 V/m (unmodulated, r.m.s.) Pulse modulation 217 Hz	5240 MHz, 5500 MHz, 5785 MHz 9 V/m (unmodulated, r.m.s.) Pulse modulation 217 Hz		

4. Essential performance

Unless the exposure switch is pressed, x-ray is not exposed.

If the Essential performance is lost or deteriorated, the device may operate inadvertently and may harm the patient, the operator, and the surrounding people.

[13] DISPOSAL

1. Disposal of x-ray unit or components

The tube head of this x-ray unit contains the lead for x-ray shield and oil, which is refined mineral oil and does not contain the carcinogenic substances such as PCBs, for the insulation.

When disposing the x-ray unit or components, appropriately dispose them complying with all current applicable regulations and local codes. In EU area, EU directive 2012/19/EU on waste electrical and electronic equipment (WEEE) is applied on this product. In this directive, environment conscious recycling / abandonment is obligated.

2. Disposal of used film covers and CCD covers

Dispose the used film covers and CCD sensor covers appropriately, according to procedures indicated by each manufacturer and all current applicable regulations and local codes.

[14] LABEL LOCATION

X-RAY CONTROLLER (MAIN)
 System model PHOT-X IIs 505 (WK) Type
 TYPE DENTAL X-RAY MODEL 505-CM
 REF AR-55WK5EU
 SN EX21E0001
 INPUT 230V ~ 50/60Hz 1.4kVA
 OUTPUT 60/70kV 3/6mA
 1:30 2sec 12sec

 Takara Belmont Corp.
 2-1-1 Higashihsanabashi, Chuo-ku, Osaka, Japan
 EC REP TAKARA COMPANY EUROPE GmbH
 Berner Strasse 18, 60437 Frankfurt am Main, Germany

(WK Type)

X-RAY CONTROLLER (MAIN)
 System model PHOT-X IIs 505 (RK) Type
 TYPE DENTAL X-RAY MODEL 505-CMRK
 REF AR-55RK5EU
 SN EX21E0001
 INPUT 230V ~ 50/60Hz 1.4kVA
 OUTPUT 60/70kV 3/6mA
 1:30 2sec 12sec

 Takara Belmont Corp.
 2-1-1 Higashihsanabashi, Chuo-ku, Osaka, Japan
 EC REP TAKARA COMPANY EUROPE GmbH
 Berner Strasse 18, 60437 Frankfurt am Main, Germany

(RK Type)

X-RAY CONTROLLER (MAIN)
 System model PHOT-X IIs 505 (FM) Type
 TYPE DENTAL X-RAY MODEL 505-CMFM
 REF AR-55FM5EU
 SN EX21E0001
 INPUT 230V ~ 50/60Hz 1.4kVA
 OUTPUT 60/70kV 3/6mA
 1:30 2sec 12sec
 Weight of whole unit 67kg

 Takara Belmont Corp.
 2-1-1 Higashihsanabashi, Chuo-ku, Osaka, Japan
 EC REP TAKARA COMPANY EUROPE GmbH
 Berner Strasse 18, 60437 Frankfurt am Main, Germany

(FM Type)

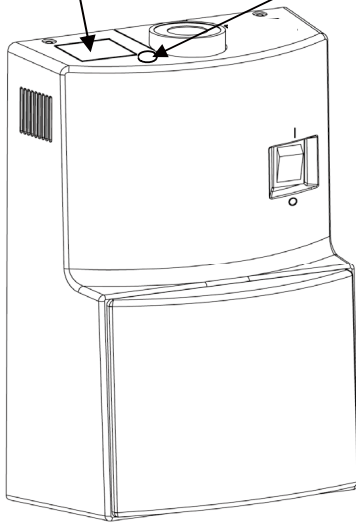

X-RAY CONTROLLER (MAIN)
 System model PHOT-X IIs 505 (FK) Type
 TYPE DENTAL X-RAY MODEL 505-CMFK
 REF AR-55FK5EU
 SN EX21E0001
 INPUT 230V ~ 50/60Hz 1.4kVA
 OUTPUT 60/70kV 3/6mA
 1:30 2sec 12sec

 Takara Belmont Corp.
 2-1-1 Higashihsanabashi, Chuo-ku, Osaka, Japan
 EC REP TAKARA COMPANY EUROPE GmbH
 Berner Strasse 18, 60437 Frankfurt am Main, Germany

(Type FK)

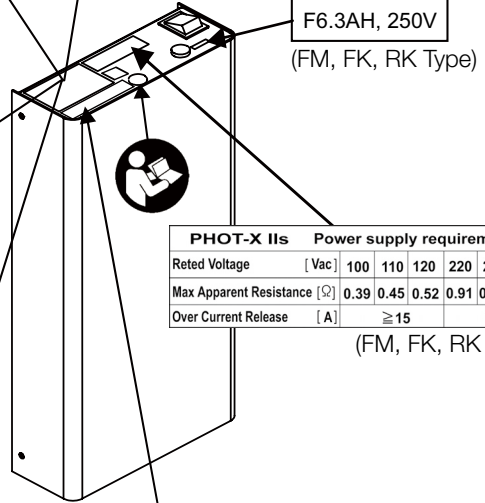

PHOT-X IIs Power supply requirements

Rated Voltage [Vac]	100	110	120	220	230	240
Max Apparent Resistance [Ω]	0.39	0.45	0.52	0.91	0.98	1.06
Over Current Release [A]	≥15		≥10			

(FM, FK, RK Type)

X-RAY CONTROLLER (MAIN)
 System model PHOT-X IIs 505 (CK) Type
 TYPE DENTAL X-RAY MODEL 505-CMCK
 REF AR-55CK5EU
 SN EX21E0001
 INPUT 230V ~ 50/60Hz 1.4kVA
 OUTPUT 60/70kV 3/6mA
 1:30 2sec 12sec

 Takara Belmont Corp.
 2-1-1 Higashihsanabashi, Chuo-ku, Osaka, Japan
 EC REP TAKARA COMPANY EUROPE GmbH
 Berner Strasse 18, 60437 Frankfurt am Main, Germany

(CK Type)

CAUTION DO NOT MOVE ENTIRE X-RAY UNIT WITH ARM EXTENDED
ATTENTION NE PAS DEPLACER L'APPAREIL COMPLET AVEC SON BRAS ETENDU.
 (FM Type)

X-RAY CONTROLLER (SUB)
 TYPE DENTAL X-RAY MODEL 505-CS
 SN EC21E0001

 Takara Belmont Corp.
 2-1-1 Higashihsanabashi, Chuo-ku, Osaka, Japan
 EC REP TAKARA COMPANY EUROPE GmbH
 Berner Strasse 18, 60437 Frankfurt am Main, Germany

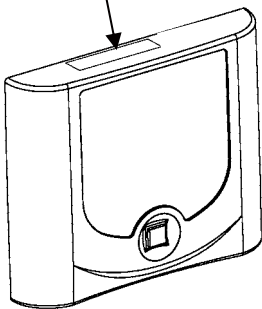

X-RAY LONG CONE
 TYPE DENTAL X-RAY MODEL 505-L
 SN ED21E0001
 SSD 305mm BEAM LIMITING DEVICE
 EXIT FIELD SIZE 58mm dia., circular

 Takara Belmont Corp.
 2-1-1 Higashihsanabashi, Chuo-ku, Osaka, Japan
 EC REP TAKARA COMPANY EUROPE GmbH
 Berner Strasse 18, 60437 Frankfurt am Main, Germany

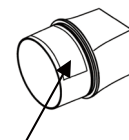
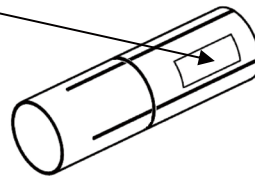

X-RAY RECTANGULAR COLLIMATOR
 TYPE DENTAL X-RAY MODEL 505-REC
 SN EE21E0001
 SSD 243mm (with regular cone), 345 (with long cone)
 EXIT FIELD SIZE 32 x 40mm, rectangular

 Takara Belmont Corp.
 2-1-1 Higashihsanabashi, Chuo-ku, Osaka, Japan
 EC REP TAKARA COMPANY EUROPE GmbH
 Berner Strasse 18, 60437 Frankfurt am Main, Germany

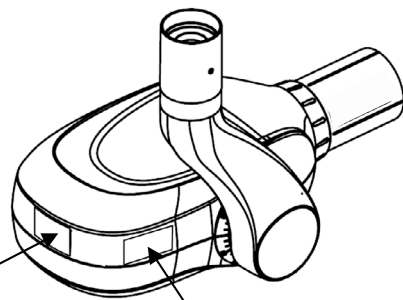

X-RAY HEAD
 TYPE DENTAL X-RAY MODEL 505-H
 SN EH21E0001
 INPUT 60/70kV 3/6mA
 TUBE MODEL D-046 1234567 CANON

 Takara Belmont Corp.
 2-1-1 Higashihsanabashi, Chuo-ku, Osaka, Japan
 EC REP TAKARA COMPANY EUROPE GmbH
 Berner Strasse 18, 60437 Frankfurt am Main, Germany

X-RAY REGULAR CONE
 TYPE DENTAL X-RAY MODEL 505-R
 SN ER21E0001
 SSD 203 mm
 EXIT FIELD SIZE 58mm dia., circular

 Takara Belmont Corp.
 2-1-1 Higashihsanabashi, Chuo-ku, Osaka, Japan
 EC REP TAKARA COMPANY EUROPE GmbH
 Berner Strasse 18, 60437 Frankfurt am Main, Germany

FOCAL SPOT VALUE : 0.4
 INHERENT FILTRATION : 1.7 mmAl Equiv
 ADDED FILTRATION : 0.3 mmAl
 TOTAL FILTRATION : 2.0 mmAl Equiv.
 RADIATION LEAKAGE RATE : 109 μGy/H at 1m

X-RAY ARM
TYPE DENTAL X-RAY **MODEL** 505-A
SN EA21E0001 2021-05

Takara Belmont Corp. **JPN**
2-1-1, Higashishinbashi, Chuo-ku, Osaka, Japan
EC REP TAKARA COMPANY EUROPE GmbH
Bernier Strasse 18, 60437 Frankfurt am Main, Germany

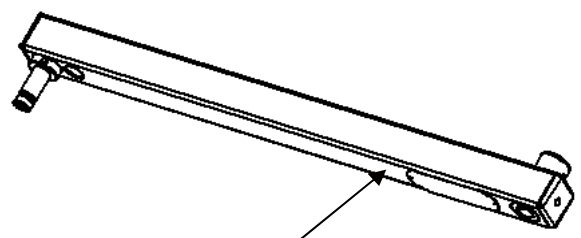
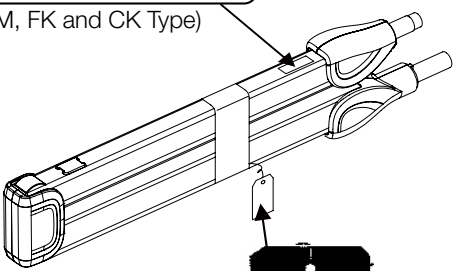
(WK, FM, FK and CK Type)

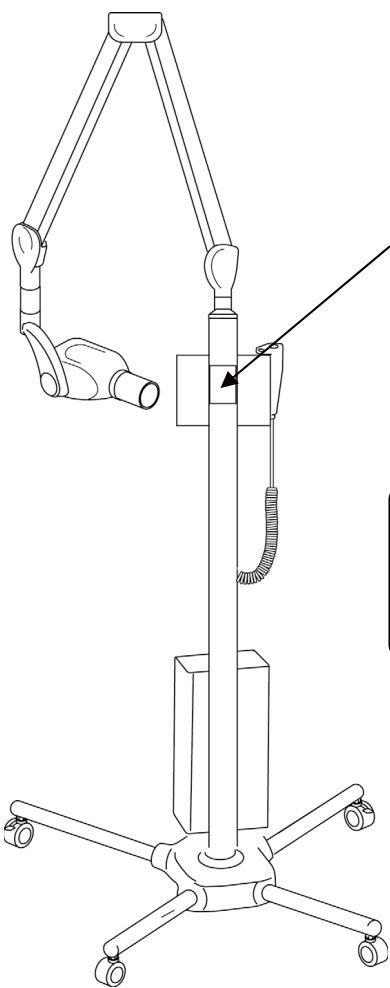

X-RAY HORIZONTAL ARM
TYPE DENTAL X-RAY **MODEL** 505-HA
SN EQ21E0001 2021-05

Takara Belmont Corp. **JPN**
2-1-1, Higashishinbashi, Chuo-ku, Osaka, Japan
EC REP TAKARA COMPANY EUROPE GmbH
Bernier Strasse 18, 60437 Frankfurt am Main, Germany

(WK and FK Type)



(FM Type)

WARNING
Keep casters in the lock position, unless moving the equipment. To avoid injury, do not push or lean on the equipment.
AVERTISSEMENT
Gardez les roulettes en position verrouillée à moins que vous ayez à déplacer l'appareil. Il y a risque de blessure si vous appuyez ou poussez sur l'appareil.

X-RAY ROOM MOUNT
TYPE DENTAL X-RAY **MODEL** 505-RK
SN EB21E0001 2021-05

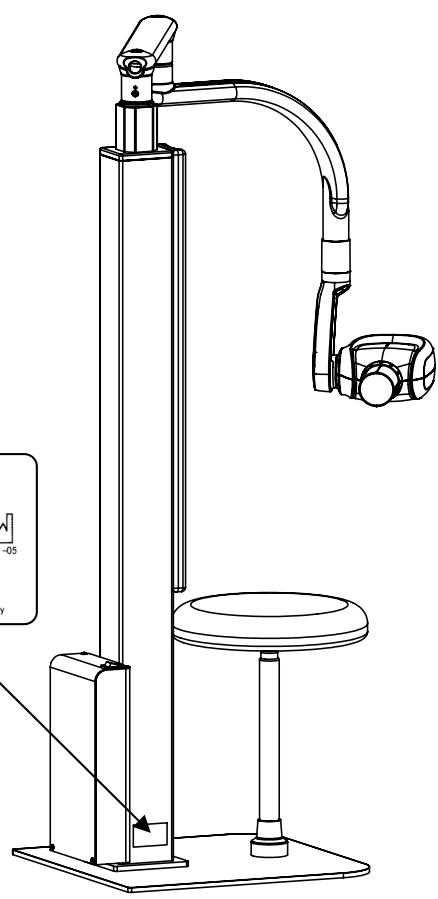
Takara Belmont Corp. **JPN**
2-1-1, Higashishinbashi, Chuo-ku, Osaka, Japan
EC REP TAKARA COMPANY EUROPE GmbH
Bernier Strasse 18, 60437 Frankfurt am Main, Germany



(RK Type)

NOTE

EC REP

TAKARA COMPANY EUROPE GmbH

Berner Strasse 18, 60437

Frankfurt am Main, Germany

Tel:+49 69 506878 0

Fax:+49 69 506878 20

 **Belmont®**



TAKARA BELMONT CORPORATION

2-1-1, Higashishinsaibashi, Chuo-ku, Osaka, 542-0083, Japan

TEL: +81 6 6213 5945

TELEFAX: +81 6 6212 3680

BOOK NO. 1A0GDRP0

Printed in Japan 2021-06